

2016

The Democratization of Food: Tin Cans and the Growth of the American Food Processing Industry, 1810-1940

Gregg Steven Pearson
Lehigh University

Follow this and additional works at: <http://preserve.lehigh.edu/etd>

 Part of the [History Commons](#)

Recommended Citation

Pearson, Gregg Steven, "The Democratization of Food: Tin Cans and the Growth of the American Food Processing Industry, 1810-1940" (2016). *Theses and Dissertations*. 2756.
<http://preserve.lehigh.edu/etd/2756>

This Dissertation is brought to you for free and open access by Lehigh Preserve. It has been accepted for inclusion in Theses and Dissertations by an authorized administrator of Lehigh Preserve. For more information, please contact preserve@lehigh.edu.

The Democratization of Food: Tin Cans and the Growth of the American Food
Processing Industry, 1810-1940

by

Gregg Steven Pearson

A Dissertation

Presented to the Graduate and Research Committee

of Lehigh University

in Candidacy for the Degree of

Doctor of Philosophy

in

History

Lehigh University

January, 2016

© 2016 Copyright
Gregg Steven Pearson

Approved and recommended for acceptance as a dissertation in partial fulfillment of the requirements for the degree of Doctor of Philosophy

Gregg Steven Pearson

The Democratization of Food: Tin Cans and the Growth of the American Food Processing Industry, 1810-1940

Defense Date

Dr. John K. Smith
Dissertation Director

Approved Date

Committee Members:

Dr. Stephen H. Cutcliffe

Dr. Roger D. Simon

Dr. Maria McGrath

ACKNOWLEDGMENTS

Without the love, support, and encouragement of my dear wife Kathy, this project would never have come to fruition. I owe her an unimaginable debt of gratitude for allowing me to pursue a dream. Our children, Sara and Phil, were somewhat puzzled and amused by dad's new career as a student, and I thank them for providing an occasional break from my studies. My dissertation committee spent many hours reading drafts and provided crucial insight which was incorporated into the final product. I thank them for their time and patience. The staff at the Hagley Museum and Library in Greenville, Delaware guided me to several significant and important sources, while the research librarians at the Carl A. Kroch Library of Cornell University were helpful, friendly and patient during my numerous visits. There were many individuals who assisted with my research at other libraries. I specifically thank Mr. Victor Dixon, the reference librarian at the Maywood Public Library in Maywood, Illinois for uncovering documents on the Norton Brothers Can Works. Victor managed to provide me time and work space at a severely underfunded public library, all with a smile. Mr. Luther Hanson, director of the U. S. Army Quartermaster Museum and Library in Fort Lee, Virginia, possessed an encyclopedic knowledge of Army supply operations, and enthusiastically unearthed Civil War era documents on canned food use by the military. Finally, I acknowledge two individuals who placed me on the road to this project twenty-five years ago. The late Mr. Bill Smith, Sr. was the CEO of the United States Can Company and offered me a position, in an industry I knew nothing about, in 1992. Mr. Joe Nicoletto was my mentor in the basics of can manufacturing. Joe was, and still is, a can-maker extraordinaire.

TABLE OF CONTENTS

List of Figures	vii
List of Tables and Charts	viii
Abstract	1
Chapter 1 - Introduction	3
Chapter 2 - The United States Military and the Tin Can	26
- History of Early Can-Making	27
- The United States Military and the Tin Can	48
Chapter 3 - Technology and the Tin Can	87
- Phase 1 - Craft or Hand-made Manufacture	90
- Nineteenth-Century Types of Tin Cans	96
- The Operation of a Canning Line	104
- The Process of Innovation in Can-Manufacturing	111
- Phase 2 - Proto-Mechanization	116
- Phase 3 - Semi-Automatic Manufacture	122
- Domestic Tin Plate Production	135
- Adoption of Technology by Can-Makers	137
- Labor Relations Issues	140
- Phase 4 - Integration and Emergence of a New Industry	149
- Phase 5 - Product Design	166
- Conclusion	184
Chapter 4 - Case Studies in Can Manufacturing	194
- Landscape of the Industry	198
- Wayne County Preserving Company	202
- The H. S. Mill Canning Company	224
- The Cobb Preserving Company	247
- Norton Brothers Can Works	261
- Large Food Marketers	274
- Conclusion	287
Chapter 5 - Consolidation of Can-Making	291
- The American Can Company	296
- The Continental Can Company	315
- Basis of Competition	320
- Middle Tier Can Manufacturers	326
- Effects of Consolidation	329
- Consolidation and Alfred Chandler	332
- Conclusion	339

Chapter 6 - Managing Demand and Customer Expectations	344
- Canned Food Consumption	346
- Urbanization	361
- The Application of Science to Canning	370
- The Pure Food Movement	380
- Trade Associations	386
- Advertising	393
- Conclusion	406
Chapter 7 - Conclusion	409
- Epilogue	417
Bibliography	422
Vita	436

LIST OF FIGURES

Figure 2.1 - Diagram of Ezra Warner's Can Opener	48
Figure 2.2 - Civil War Era "Essence of Coffee" Tin Can, front view	66
Figure 2.3 - Civil War Era "Essence of Coffee" Tin Can, reverse view	67
Figure 2.4 - 1930s Era C-Ration	84
Figure 3.1 - Drawing of Hole-in-Cap Can	98
Figure 3.2 - Wilson's Tapered Can	101
Figure 3.3 - Andrew Shriver's Kettle	109
Figure 3.4 - Various End Floaters - Merriam's and Triumph	129
Figure 3.5 - Norton's Automatic Can Line - End Attachment	154
Figure 3.6 - Norton's Automatic Can Line - View of Entire Line	154
Figure 3.7 - Sanitary Can	174
Figure 3.8 - Max Ams No. 498 Double Seamer	176
Figure 3.9 - Cover of Max Ams "Panama Exposition" Catalogue	178
Figure 4.1 - H. S. Mill Canning Company - Former Site	228
Figure 4.2 - H. S. Mill Canning Company - Original Corn Crib	229
Figure 4.3 - Postcard of Cobb Preserving Company, Circa 1900	249
Figure 4.4 - Sketch of Norton Brothers Can Works, 1894	265
Figure 4.5 - American Can Company Plant - Maywood, Illinois, 1911	269
Figure 4.6 - Modern Photo - Former Norton Brothers Can Works Site	270

LIST OF TABLES AND CHARTS

Table 3.1 - Common Can Sizes and Case Packs	104
Table 3.2 - American Tin Plate Consumption	137
Chart 3.1 - Technology Effect Over Time	181
Chart 3.2 - Technology Effect by Key Operation	185
Chart 3.3 - Technology Effect by Phase of Technological Development	189
Table 4.1 - Top Fruit and Vegetable Canning States	200
Table 5.1 - Consolidation of Can Manufacturing	331
Table 6.1 - Market Size - Canned Fruits and Vegetables - Early Twentieth Century	348
Chart 6.1 - Annual Consumption of Canned Fruits and Vegetables	349

ABSTRACT

This project draws from the history of technology and business history to determine how the transformation of the can manufacturing industry was coupled with changes in the food processing industry. Ultimately, American social and cultural change occurring in the late nineteenth century through the early twentieth century reshaped the contours of both food processing and can manufacturing. The tin can was the force that democratized food processing. The development of tin can manufacturing from a craft-based to a mass production industry between the years 1810 and 1930 occurred because of several important factors. The military use of tin cans during the American Civil War introduced and popularized the new food processing technology, but the price of canned food was beyond the reach of most Americans. It was a food source for the wealthy. The rapid development of can manufacturing technologies beginning in the 1870s through 1910s reduced the price of tin cans and made them affordable for most Americans. The deployment of technology, however, was non-uniform and canners and can manufacturers only adopted new machinery if it supported their overall business strategy. The consolidation of can-making began in the first few years of the twentieth century and by the 1920s resembled a duopoly. While consolidation and reorganization of the industry initially increased prices for canned food, competition and litigation by the federal government ensured price reductions and stability. In the early twentieth century canned food was becoming an increasingly large component of the American diet, and urbanization of American society generated

additional demand. However, there was an undercurrent of suspicion associated with canned food among some consumers. The application of science, formation of a national trade association, and advertising all reassured American consumers about the safety of canned food and grew the market for these products. By the end of the 1920s, canned food was now a food processing technology demanded by Americans in ever increasing quantities and no longer the exclusive preserve of the wealthy. The ignoble and ubiquitous tin can was the technology which facilitated the growth of the food processing industry in nineteenth-century America. The development of the tin can as a container for food was regarded as nothing short of a revolutionary innovation in industrial America.

Chapter 1 – Introduction

When tomorrow's historians study the ways of the twentieth century, they will find the imprint of five industrial corporations that, more than any others, shaped the daily life of man in the U.S. Four of them are Ford Motor, General Electric, American Tel. & Tel., and R.C.A. The fifth is American Can Co. The absence of any of the five, or of the industry it symbolizes, would change the pattern of life in the U.S. past recognition.

Fortune Magazine, 1941¹

Few contemporary historians of technology or business would place the tin can alongside such significant technologies as the automobile, electricity, telephone, or radio, as noteworthy inventions of the late nineteenth and early twentieth centuries. However, American historians and business writers of the early twentieth century saw it as a life-changing innovation. The specific technological challenge was mass producing an item with manufacturing tolerances measured in thousandths of an inch. In the nineteenth century, the mass production of canned food required inexpensive and reliable tin cans and this process took decades of technological development. The result, by the early twentieth century, was a safe and inexpensive container, which became a staple item in most American kitchens. The American Can Company was the foremost manufacturer of food cans for most of the twentieth century, so *Fortune's* acclamatory comments are accurate. The tin can would revolutionize food processing, saw its popularity in America begin during the Civil War.

John D. Billings enlisted as a private in the Tenth Massachusetts Battery, a volunteer Union artillery regiment, in 1862. Billings was fortunate to survive the Civil

¹ Unattributed, "American Can Company," *Fortune Magazine*, January 1941, p. 53.

War and, after coaxing by numerous relatives and acquaintances, in 1881 decided to record his observations and experiences while a soldier in the Army of the Potomac. His work, *Hardtack and Coffee: The Unwritten Story of Army Life*, documents the life of a common soldier in the Civil War. Billings discussed enlistment, camp life, discipline and punishment, soldier shelters, clothing, communication, and Army rations. Ever the keen observer, he said the following about canned food:

He [the Regimental Sutler] had a line of canned goods which he sold mostly for use in officers' messes. The canning of meats, fruits, and vegetables was then in its infancy, and the prices, which in time of peace were high, by the demands of war were so inflated that the highest of high privates could not aspire to sample them unless he was the child of wealthy parents who kept him supplied with a stock of scrip or greenbacks.²

Billings revealed several important characteristics of canned goods in the 1860s. First, they were expensive, and limited to those soldiers who could afford them, namely officers. Billings further stated that a can of condensed milk, itself a product of technological innovation of the 1850s, cost "seventy-five cents a can," a price that was beyond the reach of a private making thirteen dollars a month.³ While enlisted soldiers saw canned goods, predominantly peaches, blackberries, raspberries, tomatoes, and condensed milk, they could not afford them -- a rather elitist and undemocratic attribute of the new food preservation technology. Second, Billings instructed his readers that in the early 1860s canning was in its "infancy," and implied that the

² John D. Billings, *Hardtack and Coffee or The Unwritten Story of Army Life* (Boston: George M. Smith and Company, 1887), 224-225.

³ *Ibid.*, 225.

availability of canned goods had changed in the course of twenty-five years. He left unanswered what had happened to canned goods in the two decades since he first experienced them in the Civil War. What had occurred after the Civil War was that over the course of roughly fifty years, through several factors working in concert with one another, the price of canned goods decreased so much that they became affordable for most Americans. The novelty and exclusivity associated with canned goods had faded as the tin can became a ubiquitous, pervasive, and everyday item of the American food landscape.

This study explains the process of production of cans and the increasingly democratic distribution of canned goods throughout America from 1810 through the 1930s. It links the transformation of the food processing and can manufacturing industries to social and cultural change occurring during this time period -- the kinship between the kitchen and the can. The intervening period between Billings' Civil War experiences and the publishing of his memoir were critical to the process of production and further distribution of canned goods, but the most significant technological progress occurred in the last two decades of the nineteenth century.

The transformation of tin can manufacturing from a craft-based to a mass production industry occurred because of six important factors. The military use of tin cans diffused the new technology; the rapid development of technologies in can manufacturing increased supply and lowered costs; the corporate form of business organization rationalized the industry and further lowered costs; while urbanization, the

application of science to canning, and the growing ethic of consumption all increased demand. The can manufacturing industry developed into an effective duopoly in the early twentieth century that remained virtually unchanged until the 1980s.

For a number of reasons, the history of tin cans is significant for historians of technology and food. First, it illustrates major trends in American industrial and consumer history. The development of this technology touches upon trial-and-error innovation processes, the secretiveness surrounding innovation, the eventual advent of scientific technological innovation, diffusion of new technologies, the reaction of labor to technological change, the rise of mass retailing and other distribution chains, and the early twentieth century wave of corporate mergers. Furthermore, utilizing a case study approach for investigating technological diffusion adds depth to the understanding of differing rates of technological adoption. Second, this project departs from histories of technology focused on large, well-known, technologies, production systems, and inventors. Instead, it traces the development of a small, somewhat unknown and relatively ignored technology, the tin can. While there has been important work done on major modern technologies, such as the automobile, radio, electricity, and the telephone, to name just a few, there has been less work on common, every-day technologies. The tin cans was a less glamorous, yet life-changing, technology.

The history of food has become a field of considerable importance within American historical and cultural studies. This project adds to the breadth and boundaries of food history by explaining the relationship of tin can technology to

American technological, business, social, and cultural change. It departs from food histories centered on ethnicity, taste, industrialization, or gender. Additionally, food historians have acknowledged canning as a major development in changing American foodways, but the tin can has been relatively ignored. The tin can was the technology which enabled mass production of canned food. This history places the development of the tin can alongside food processing. This "can first" approach distinguishes this work from other histories of food preservation. In most food preservation monographs cited in this study, the can often takes a secondary role to the process of canning itself; yet, it was the technology which enabled the advent of canned meat, fruit, vegetables, and seafood. Moreover, this project is a fresh approach to the history of the tin can, free of the hagiography of the past "can-centric" works. The most recent works which attempt to place the tin can in the context of major historical trends, such as *The Story of Canned Foods* by James H. Collins, and *The Canning Clan* by Earl Chapin May, were written in the 1920s and 1930s.⁴

The primary sources for this project are quite varied -- government reports, industry trade catalogues, oral histories, newspapers, company manuscripts and letters, advertising copy, patent records, court documents, and census data. Using this array of sources, I detail how can manufacturing evolved from craft-based production to a high-speed, automated, mass production industry in the span of roughly one hundred years. Key questions in the early nineteenth century focus on the inception and early history of

⁴ James H. Collins, *The Story of Canned Foods* (NY: E. P. Dutton and Company, 1924); Earl Chapin May, *The Canning Clan: A Pageant of Pioneering Americans* (NY: The MacMillan Company, 1937).

the tin can and canning. How, why, and where did can manufacturing begin? What were the advantages and disadvantages of canning as a new form of food preservation? Who were the early users of canned goods? What was the role of the United States military in promoting the use of canned goods?

The post-Civil War era ushered in a period of rapid technological innovation in can manufacturing. The story revolves around the innovators, mechanical devices, the process of innovation, and benefits for consumers. Who were the seminal figures in the creation of the industry and development of technology? What were the incremental and breakthrough technologies during the early growth stage of the industry? Was there a definable process behind the diffusion of can-making technology amongst firms who purchased the most modern machinery? Were there benefits for consumers, in the form of lower retail prices, stemming from increased mechanization and automation of canned goods manufacturing?

In the late nineteenth century, can manufacturing separated from canning and arose as a distinct industry. There are several important questions from this period of development. Who were the major can manufacturers and packers? How, when, and why did a separate can manufacturing industry arise independent of self-manufacture by packers and canners? Under what conditions did self-manufacture make economic sense? How did the rise of a corporate structure of governance in the late nineteenth century affect can manufacturing? Did industrial concentration assist in making canned goods affordable for more Americans?

Canning and can manufacturing entered a period of maturation in the first two decades of the twentieth century. The industries were keenly affected by social and cultural factors. Key questions center upon how the industries reacted to consumer expectations and social change. How did science influence the development of the can manufacturing and canning industries? What were the effects of urbanization and consumerism? Did consumers willingly accept the tin can as a new and innovative food preservation technology? Was there a paradox of increasing demand for canned foods at the same time there was consumer resistance to this form of mass-produced food?

This study begins with a chapter on the early history of the tin can and the role played by the military as a key diffuser of canned food during the Civil War. The focus of this chapter is on how and why the military institutionalized the use of tin cans, as they were a "special" item during the Civil War. Controversies, such as "tainted beef" also known by the troops as "embalmed beef," during the Spanish-American War, indicate military adoption was often problematic.

The third chapter addresses technological changes in canning and can-making from craft manufacturing techniques to mass production. It explores which part of the can-making process was mechanized at differing points of technological development, why it was chosen, the key technologies involved, and what the effects of this change were on the price of canned food. Individual inventors, and to a lesser degree, corporate researchers, were the sources of innovation. Most of the pre-Civil War innovations concerned mechanical devices designed to more effectively cut tinsplate.

After the Civil War, a plethora of innovations touched nearly every facet of the can-making process from cutting metal, pressing ends, soldering components together to make a container, to testing the tin can for leakage. Edwin O. Norton of Chicago was arguably the foremost can-making machinery inventor of the late nineteenth century and future founder of both American Can Company (ACC) and Continental Can Company (CCC). Trade catalogues from can-making machinery companies, such as the Ferracute Machine Company, E. F. Kirwan, A. K. Robins, Cox, Bliss, Ayars, Hawkins Cappers, Sprague Machines, and Max Ams Machine Company, were used to trace the history of the mechanical devices, machines, and production lines used in can production. These major equipment manufacturers supplied equipment to a vast array of customers ranging from a farmer who wanted to manufacture cans and pack his own produce to major canneries desiring self-manufacture on a large scale.

The fourth chapter investigates diffusion of mechanized can-making through the use of case studies, because it was not a monolithic process. There were generally three types of canners: those who manufactured their own cans; some who made a portion of their own cans but purchased particular sizes from a third party; and those who purchased all their requirements from a specialist can manufacturer. Over time, fewer and fewer canners self-manufactured and most began purchasing from specialized can-makers. The decision on whether to purchase can-making equipment and self-manufacture depended upon a variety of factors; the size of the operation, complexity of the product line, local labor supply, and labor relations with unions were factors

affecting this decision. There are business records available for several can-making and canning companies that serve as models for firms with different business decision making criteria. The Edgett-Burnham Company of Newark, New York, was a canner and self-manufacturer of cans. A second company, the H. S. Mill Canning Company of Springtown, Pennsylvania, was a small regional canner that did not manufacture its own cans, purchasing sanitary cans from Cobb Preserving and hole-in-cap cans from a business agent in New York City. The third company, the Cobb Preserving Company of Fairport, New York, made its own cans and also developed the innovative sanitary can, the first can without soldered tops and bottoms, in the early 1900s. The fourth case study is the Norton Brothers Can Works, initially located in Chicago. This case represents a new form of late nineteenth-century business enterprise -- the can-making company. There was no canning done at this facility, just high-volume can manufacturing using state-of-the-art equipment and processes. Finally, as a basis of comparison, the can-making choices made by large food marketers, such as the Campbell Soup Company, H. J. Heinz, and Borden's Condensed Milk, are examined.

The fifth chapter considers the effects of rationalization and consolidation upon the can-making industry. Alfred Chandler has a brief description of the rationalization of the industry in *The Visible Hand* (1977). However, as will be discussed in this study, there was no Chandlerian economic rationale for the structure of the industry to take the course it did. The concentration of the industry occurred with the formation of American Can Company (ACC) in 1901 and Continental Can Company (CCC) in 1904. ACC

and CCC institutionalized corporate research and development efforts, and brought many innovations to the market through their "scientific" approach to technology management. The formation of ACC was extremely important to the twentieth century progress of can manufacturing, but their early business practices were considered monopolistic by the federal government and, ironically, offered avenues for other manufacturers to enter the national or regional market. In 1913 a suit was filed against ACC by the federal government alleging violations of the Sherman Anti-trust Act. The 1913 case is significant because it recounts the formation of ACC through an investor group in 1901, and it ultimately legitimized the industry duopoly.

The final chapter centers on how urbanization, consumer expectations, and the consumption ethic created challenges and opportunities for canners and can-makers. The growth of canning and can manufacturing intrinsically is linked to urbanization. The kitchens in many urban apartments were small, lacked refrigeration and storage space, and had few cooking appliances; therefore they were amenable to heating the contents of a tin can. The key question addressed in this chapter is how the canning industry and consumption grew with urbanization of the American population despite some level of consumer resistance and concern over the safety of eating canned foods.

The transformation of American tastes to accepting mass-produced canned foods was not without controversy, as there was some popular concern, debate, and resistance to the new technology. Can manufacturers and food service firms addressed these concerns through the prestige of science, the formation of national trade

associations, and advertising. By taking these actions, the market for canned foods grew substantially between 1900 and the early 1920s. Demand was driven by the quest for modernity, convenience, improving family health, and the desire to add more variety to diets by eating foods not locally or seasonally available. Virtually all producers of food-related products, can-making companies included, targeted women, particularly housewives, in their advertising. The pages of "The Saturday Evening Post" and "The Ladies' Home Journal" provide many examples of this aspect of advertising and demand creation using various themes targeting housewives.

This study begins in the early nineteenth century and ends in 1940. By that time, the tin can was no longer a food preservation technology for the wealthy, but had become an affordable addition to the diets of most Americans. As the emphasis of this project is on food cans, carrying the project forward to the 1940s and beyond does not add significant breadth or depth to the main focus, for a number of reasons. First, the use of food cans by the military was well recognized and accepted by the 1930s. Detailing the uses by the military of food cans in World War II, the Korean War, and Vietnam would not yield additional insights into the military as a key diffuser of technology, which had occurred in the late nineteenth century and had fully blossomed by World War I. Second, can-making entered a phase of incremental innovation after the 1920s. After the development and diffusion of the sanitary can, most research and development efforts centered upon discovery of interior linings to hold specific food products, which had previously been unable to be packaged in a tin can, and production

engineering to reduce the weight of steel used in manufacture. Finally, because canned food had become ubiquitous for American consumers by the early twentieth century, the focus of this project is on how this process occurred. While cans sold per capita continued to expand well into the 1970s, slowly the tin can market was under threat from alternative packaging technologies. These contemporary developments will be discussed in the conclusion.

There is no single category of "literature" for can manufacturing. Most scholarship on can manufacturing, when mentioned at all, is a very small portion of the larger history of food preservation. The literature for canning and can manufacturing is variegated and stems from five types of sources. First, historians of technology and a few non-historians have studied can manufacturing and canning, yet there has been no full length, professional treatment of the industry, at least since 1937. Second, industry trade associations, such as the National Canners Association and Can Manufacturers Institute have published several studies. However, these publications are often very promotional in nature and must be used with caution. Third, government publications, such as military reference manuals on the proper use and handling of canned food, are important sources for determining the interaction of can manufacturing, canning, and institutionalization by the military. Fourth, a number of dissertations written over the past forty years have enriched the history of canning. These studies are either regional in nature, or treat aspects of food processing exclusive from can manufacturing. Finally, current histories in both food and gender studies address the social and cultural

implications of food, but few address the tin can or canning and its implication for food history.

Historians of technology have regarded the development of the tin can and canning as innovations immensely beneficial to mankind. Although Lewis Mumford, in his seminal work *Technics and Civilization* (1934), was extremely pessimistic about technological developments improving the human condition in his mostly nineteenth-century paleotechnic phase of human civilization, his exceptions were clothing and food processing. Mumford said, "Apart from the mass-production of clothes and the mass-distribution of foods, the great achievements of the paleotechnic phase were not in the end-products, but in the intermediate machines and utilities."⁵ In a similar vein, Siegfried Giedion in his study *Mechanization Takes Command: A Contribution to Anonymous History* (1948), believed that the development of canning brought an immense positive benefit to human nutrition, from both the standpoint of diet variety and quantity of available food. Yet this increase in availability would have been impossible without the tin can. According to Giedion, "the time of full mechanization [in food processing] is identical with the time of the tin can."⁶ In his opus on the history of technology, *A History of Technology* (1958), Charles Singer said of the importance of canning and the tin can: "the history of canning is bound up with the history of the evolution of the tinned can, without which the usefulness of the process would have

⁵ Lewis Mumford, *Technics and Civilization*, 1934. Reprint ed. (Chicago: The University of Chicago Press, 2010), 206.

⁶ Siegfried Giedion, *Mechanization Takes Command: A Contribution to Anonymous History* (New York: Oxford University Press, 1948), 42.

been enormously restricted."⁷ The social historian Daniel Boorstin, in his work *The Americans: The Democratic Experience* (1973), provided a brief history of canning and the tin can and believed that tin cans provided consumers a "kitchen garden," and added almost limitless variety to the human diet, especially in the urban market.⁸ Finally, the economic historian Joel Mokyr in his study *The Lever of Riches* (1990) argued that technology preceded science in food preservation, yet even empirical progress in canning and the manufacture of tin cans had the "ability to increase both the quantity and quality of the supply of goods and services" and "did much to alleviate human suffering."⁹

Ruth Schwartz Cowan took a more cautionary approach to the unfettered march of technological progress through society in much of her work which stressed consideration of the consumer in relation to acceptance of technology. Her perspective requires this study to address consumer concerns on acceptance or resistance to food packaged in tin cans. Her approach forms the basis for much of the argumentation in chapter six which focuses on actions taken by the canning and can manufacturing industries to placate potential consumer concerns. Her 1976 article entitled "The 'Industrial Revolution' in the Household: Household Technology and Social Change in the

⁷ Charles Singer, E.J. Holmyard, A.R. Hall, and Trevor I Williams, *A History of Technology: The Late Nineteenth Century, c. 1850*, Volume 5 (NY: The Oxford University Press, 1958), 43.

⁸ Daniel J. Boorstin, *The Americans: The Democratic Experience* (New York: Random House, 1973), 321-322.

⁹ Joel Mokyr, *The Lever of Riches: Technological Creativity and Economic Progress* (NY: Oxford University Press, 1990), 83, 139-140.

Twentieth Century,"¹⁰ argued that technology changed the structure of housework in the early twentieth century, but it also added new tasks. Tin cans saved the housewife time and were convenient, yet the time saved on food preparation was consumed by other household tasks, such as childcare, shopping, and home upkeep. In her 1987 essay "The Consumption Junction: A Proposal for Research Strategies in the Sociology of Technology,"¹¹ Cowan argued that researchers must consider consumers and their networks of social relations when investigating available technological choices. Canners and can-makers came to recognize that consumer expectations were important to the growth of their industries in the early twentieth century.

The consolidation and rationalization of food processing and can manufacturing was addressed by business and economic historian Alfred Chandler in his Pulitzer Prize winning study on the rise of the modern corporation, *The Visible Hand* (1977). This work explained the process of industry consolidation of can-making in the early twentieth century, but is not entirely persuasive. It is the major work challenged in chapter five. Chandler argued that adaptation of continuous processing technologies and automatic can-manufacturing lines allowed firms such as Borden's, Campbell's Soup, H. J. Heinz, Libby's, American Can, and Continental Can to dominate their markets for food processing and can manufacturing. Chandler stated that "pioneering producers of low-priced packaged goods manufactured by means of continuous-process machinery

¹⁰ Ruth Schwartz Cowan, "The 'Industrial Revolution' in the Home: Household Technology and Social Change in the 20th Century," *Technology and Culture*, Vol. 17, No. 1 (January, 1976).

¹¹ Ruth Schwartz Cowan, "The Consumption Junction: A Proposal for Research Strategies in the Sociology of technology," in *The Social Construction of Technological Systems*, eds. Weibe E. Bijker, Thomas P. Hughes, and Trevor Pinch (Cambridge: MIT Press, 1987), 261-280.

. . . continued to prosper."¹²

My study finds Chandler's analysis to be inadequate to explain the evolution of the can manufacturing industry. Chandler stressed the large-firm dominance of supply, but underemphasized the importance of increased demand in the early twentieth century created by many of the large food processing and can manufacturing giants, through advertising and other means of retailing. The importance of advertising and demand creation is addressed in chapter six.

The second source for literature on can manufacturing comes from the industry itself. These sources contain many important insights on the canning and can manufacturing industries. The two most valuable sources are Arthur I. Judge's *A History of the Canning Industry By Its Most Prominent Men* (1914) and C. H. Stecker's promotional piece entitled *The Seal of Safety Year Book* (1915). Judge was the editor of a monthly trade magazine *The Canner*, and produced a souvenir booklet for the 1914 National Cannery Association convention. The great value of his compilation is that it contains articles, on a wide variety of topics, written by many of the founders of canning and can manufacturing. Stecker's work was published by the Max Ams Machine Company to promote the sanitary can, for which they provided the can-making and lining equipment. It contains sections on canning by region and product line, but also insightful and very descriptive sections on hand-made cans in the 1860s and the development of the sanitary can. Two works published by Averil Bitting, the head

¹² Alfred Chandler, *The Visible Hand: The Managerial Revolution in American Business* (Cambridge: Harvard University Press, 1977), 349.

scientist for the National Cannery Association, contain information regarding the development of the industry, but they are primarily treatises that provide a scientific basis for processing foods using cans. Bitting's intention was to lift the veil of secretiveness surrounding proper canning methods. The publications, *Canning and How to Use Canned Foods* (1916) and *Appertizing or The Art of Canning: Its History and Development* (1937) both have the same purpose -- inform the public on how canned foods were manufactured and their incorporation into recipes in the home. They are promotional in nature and designed to combat perceived negative public connotations associated with tin cans, but they also serve the function as "recipe books" for canners by providing information on cook times, pressures, and temperatures for nearly every imaginable type of food.

There are three additional important monographs on canning and can manufacturing. Not published by industry sources, but by outside observers of the industry, these works comprise the few full-length studies of canning and can manufacturing. In 1924 James H. Collins, an associate of the owners of the Del Monte Corporation, published *The Story of Canned Foods*. Collins presented a comprehensive summary of facts, but neglected the process of industry consolidation, ignored the role played by the military as a diffuser of the tin can, and generally provided very little historical context for canning or the tin can. Another work, *The Canning Clan: A Pageant of Pioneering Americans* (1937) by Earl Chapin May is the most complete published work on the history of canning and can-making through the 1930s, but it is mostly a

hagiography of the persons and personalities in the canning industry. The final monograph on canning is *Tin Cans and Tin Plate: A Study of Competition in Two Related Markets* (1959) by economic historian James McKie, a study of competition in the tin can and tinplate industries. It provides insightful background information on the formation of a market duopoly with ACC and CCC, yet only briefly addresses the 1913 anti-trust case against ACC. The author argued that there was "workable competition" even within this duopoly because both ACC and CCC complied with court orders, continued their research and development efforts, and maintained low enough margins on their products.

A third literature source, government reports from the post-Civil War era on the use of tin cans, support the argument that the military was a key institutional diffuser of tin cans. Canned foods were available during the Civil War, but there were limited instances in which they were distributed. Canned food was much more commonly consumed by officers during the Civil War, while enlisted soldiers enjoyed them infrequently. The first report on canned goods was prepared in 1867 by Captain Thomas Wilson, an officer in the Subsistence Department of the Commissary General. Wilson was specifically charged with investigating how canned goods were procured and used during the Civil War. This work was primarily intended to be a reference manual for those officers whose responsibilities included purchasing canned goods. There were two other significant publications by the Army in the late nineteenth and early twentieth centuries concerning canned foods and both were entitled "Handbook of

Subsistence Stores." The 1896 version included government specifications for canned goods purchases with specific sections on key components of the military diet, such as beans, beef, milk, jams, peaches, and tomatoes. The 1900 edition added a section on storage of canned goods in extreme hot or cold environments. Both the 1896 and 1900 "Handbooks" reveal growing and increasing institutional attempts at disseminating knowledge on canned goods, and the transition to investigation based upon scientific principles versus trial and error.

The fourth source for literature on canning and can making are recent dissertations in the history of technology or food history fields. Edward F. Keuchel wrote "The Development of the Canning Industry in New York State to 1960" in 1970. Despite the regional focus of his work, the dissertation described the nationwide expansion of canning in the nineteenth century, specific technological innovations which improved throughput in both canneries and can factories, and impediments to commercialization of the tin can for consumers. Mark Wilde's 1988 work, "Industrialization of Food Processing in the United States," is a much more generalized work than Keuchel, but it included a section on peach canning. His conclusion is that technology was just one factor influencing the growth of canned foods, while social, cultural, and political factors "figured in the story."¹³ Gabriella Petrick, in her 2006 dissertation "The Arbiters of Taste: Producers, Consumers and the Industrialization of

¹³ Mark William Wilde, "Industrialization of Food Processing in the United States" (Ph.D. diss., University of Delaware, 1988), 61. Wilde's work is unique because it investigated more factors than just technological innovation as forces that expanded the popularity of tin cans, an argument with which this author strongly agrees.

Taste in America, 1900-1960," argued that the interplay between science, technology, and cultural practice changed Americans' perceptions of taste and the food they consumed. While there is much useful material in her work and her overall hypothesis is plausible, it contains inaccuracies concerning many of the technological developments in can manufacturing. The most recent dissertation on food and technology is Katherine Leonard Turner's 2008 work "Good Food for Little Money: Food and Cooking Among Urban Working-Class Americans, 1875-1930." Turner argued that material conditions, the physical environment of the urban working-class, not just cultural heritage, influenced what urban working-class Americans ate. Material conditions affected how they shopped, prepared, and arranged their residences. Her work also contains some insights used in chapter six, on how canned foods were a viable option for working-class foodways, once the price of these items reached reasonable levels.

Recent work in the field of food history contains some literature on canning and tin cans. One of the first comprehensive works on cultural values and food was *The American and His Food* (1970) by Richard Cummings. The author argued that physical attributes and patterns of socialization of the American people have been affected by social and technological changes to their diet. With Cummings as a foundation, other authors expanded upon his findings. In *Never Done: A History of American Housework* (1982), Susan Strasser argued that economic dependence persisted for American women in the early twentieth century. Strasser stated that "industrialists ignored many of the patents for household labor-saving devices because they could not produce them

profitably; they produced others, like canned foods and washing machines for military and commercial application, decades before they offered them to households."¹⁴ The factor limiting availability of canned goods for middle-class households was the price of the tin can, and efforts were underway as early as the 1870s to make them more affordable, a point disregarded by Strasser. In 2000 Priscilla Brewer published *From Fireplace to Cookstove: Technology and the American Domestic Ideal*. Brewer posited that "the cookstove has always been about more than cooking."¹⁵ She argued that the cookstove touched upon debates about the role of women, the meaning of the home, the impact of industrialization, the definition of social class, and development of a consumer economy. Brewer provided much useful information on the innovation process and diffusion of stoves in both urban and suburban environments. Her work is one of the few in the food history literature which investigates a singular technology and its role in American society.

Another segment of food history literature which is important for this project is consumption and urbanization studies. The foundational work is Lizabeth Cohen's *A Consumer's Republic: The Politics of Mass Consumption in Postwar America* (2003). Cohen argued that the mass consumption ethic arose in America after World War II, and that American social, cultural, and political landscape was transformed by consumption. The importance of her work lies in the idea of consumption as a transformative

¹⁴ Susan Strasser, *Never Done: A History of American Housework* (New York: Henry Holt and Company, 1982), 8.

¹⁵ Priscilla J. Brewer, *From Fireplace to Cookstove: Technology and the Domestic Ideal in America* (Syracuse: Syracuse University Press, 2000), xv.

behavior, a fact canners and can-makers used in early twentieth-century advertising, as explained in chapter six. Two other works explore consumption in urban working class environments. In *Household Accounts*¹⁶ Susan Porter Benson argued that working-class consumption is one aspect of a complicated set of economic activities, but canned food found a place in working-class households because it became affordable over time. Similarly, Katherine Leonard Turner in her essay "Tools and Spaces"¹⁷ argued that material culture forced tradeoffs between effort and income for the working-class, and that their choices of preparation tools and spaces in which to cook, were often limited in a typical working-class kitchen of the early twentieth century.

Ultimately, American social and cultural change occurring in the late nineteenth century through the early twentieth century reshaped the contours of both food processing and can manufacturing. The development of tin can manufacturing from a craft-based to a mass production industry between the years 1810 and 1930 occurred because of six important factors: the military use of tin cans during the American Civil War, the rapid development of technologies in can manufacturing, the corporate form of business organization, the urbanization of the American population, the application of science to canning, and the growing ethic of consumption in American society. The pedestrian and ubiquitous tin can was the technology that facilitated the growth of the food processing industry in nineteenth-century America. The development of the tin

¹⁶ Susan Porter Benson, *Household Accounts: Working-Class Family Economics in the Interwar United States* (Ithaca: Cornell University Press, 2007).

¹⁷ Katherine Leonard Turner, "Tools and Spaces: Food and Cooking in Working-Class Neighborhoods, 1880-1930," in *Food Chains: From Farmyard to Shopping Cart*, eds. Warren Belasco and Roger Horowitz (Philadelphia: University of Pennsylvania Press, 2009), 217-232.

can as a container for food was regarded as nothing short of a revolutionary innovation in industrial America and was an efficient method to feed growing urban populations. Today, a consumer takes for granted the plethora of items available in the canned goods aisle of a local grocery store, but this insouciance should properly be tempered by the technological, business, and social history which facilitated this outcome.

Chapter 2 - The History of Early Can-Making and the Impact of the United States Military on Diffusion of the Tin Can

The invention of bully beef [canned roast beef] had profited us more than the invention of gunpowder, but gave us a strategical rather than tactical strength, since in Arabia [World War I] range was more than force, space greater than the power of armies.

T. E. Lawrence (Lawrence of Arabia), 1935¹

Military needs not only stimulated output and adventure, but frequently created new industries.

J. F. C. Fuller, 1945²

Canning has helped develop modern ways of life and waging war.

Charles Singer, 1958³

The invention of canning in the nineteenth century improved the overall standard of living for much of the world and establishing conditions for modern living. It facilitated the urbanization of America by allowing workers, who were now separated from the point of food production, to have access to a source of nutrition.⁴ Canning added needed variety and more nutrition to diets. It also removed obstacles to living in areas unable to produce adequate amounts of food to sustain life, thereby promoting population and demographic expansion into previously uninhabitable locales, such as

¹ T. E. Lawrence, *Seven Pillars of Wisdom: A Triumph* (Dorset Press Edition (1988), New York: Doubleday, Duran and Company, 1935), 196. The British term 'bully beef' is derived from the French word *bouilli* meaning a mixture of beef and vegetables boiled in water, Mary Earle Gould, *Antique Tin and Tole Ware: Its History and Romance* (Rutland, Vt.: Charles E. Tuttle Company, 1958), 83-84.

² J. F. C Fuller, *Armament and History: The Influence of Armament on History from Classical Warfare to the End of the Second World War* (London: Charles Scribner's and Sons, 1945), 53.

³ Singer, *A History of Technology*, Volume 5, 38.

⁴ *Ibid.*, 1-2, 26-27.

arid and frigid climates.⁵ Canning increased both the quantity and quality of goods available, compared to fresh foods, and contributed to the alleviation of human suffering from nutritional deficiencies or consumption of possibly contaminated goods from other methods of food preservation. Canned food was also a medium of exchange. The additional amounts of food preserved via canning were used for barter or sold to obtain other needs.⁶ Finally, canning "leveled time" by eliminating the effects of seasonality. It was a method of "cheating nature."⁷ People could now save food from harvests to sustain themselves through periods of low agricultural productivity. The cycle of feast or famine could now be successfully broken. Canning was a force which not only improved nutrition, it also changed social and cultural patterns of living.

History of Early Can-Making

Prior to canning and tin cans, there were two general methods for food preservation, but both these techniques had severe limitations. Natural methods included freezing, drying, and storing foods at low temperatures or in cellars. They attempted to diminish the negative effects of heat, moisture, and contact with air. These methods required no additional technologies to preserve foods and utilized conditions provided by the natural environment. Artificial methods introduced a type of

⁵ Ernest S. Hedges, *Tin in Social and Economic History* (New York: St. Martin's Press, 1964), 150-151.

⁶ Joel Moky, *The Lever of Riches*, 139-140; Sue Shephard, *Pickled, Potted, and Canned: How the Art and Science of Food Preserving Changed the World* (New York: Simon and Schuster, 2000), 21.

⁷ Shephard, *Pickled, Potted, and Canned*, 17.

chemical process or element designed to resist fermentation or putrefaction. This category of food preservation included salting, smoking, pickling with vinegar, sugaring, and spicing.⁸ These methods were an improvement over many of the natural methods of food preservation and were quite common prior to canning, but they were used primarily on meat and fish. Few fruits and vegetables could be preserved for long periods of time. The shortcomings of these processes were many. They were all temporary techniques of arresting degradation of food and they were generally limited to the area in which the food was produced. The techniques were susceptible to changes in the environment, especially the "natural" methods, and were also limited by the availability of the elements required for "artificial" preservation, such as salt, sugar, and spices. These methods of food preservation did extend food supplies, but a process was required that could be used on fruits and vegetables and to sustain preservation for all foods over longer periods of time.

There were attempts to develop effective methods of longer term preservation or canning in the eighteenth century, but none proved successful. Fruit bottling, using sugar, was common as early as the seventeenth century.⁹ Fruit was submerged in a solution of sugar and water and placed in a glass container. No heat to sterilize the fruit was applied to the container, so while the life of the fruit was extended for a short period of time, it soon became putrid from microorganisms. This method was practiced

⁸ Edith Elliott Swank, *The Story of Food Preservation* (Pittsburgh: H. J. Heinz Company, 1943), 11-16; A. W. Bitting, *Appertizing or The Art of Canning; Its History and Development* (San Francisco: The Trade Pressroom, 1937), 25-46.

⁹ Stuart Thorne, *The History of Food Preservation* (Totowa, N.J.: Barnes and Noble Books, 1986), 28.

on a domestic scale and there was no attempt to extend fruit bottling to a commercial level. There was some recognition in England (Needham in 1745), Italy (Spallanzani in 1765) and Germany (Scheele in 1782) that food could be preserved through a combination of heating and exclusion of air, but none of them developed any practical method to capitalize on their ideas. In 1787 the English Society of Arts, later renamed the Royal Society of Arts, offered a prize for an improved method of preserving food. In 1808 the Society awarded a portion of the prize to Thomas Saddington for his description of a process to submerge filled glass vessels, sealed with a cork, in boiling water for a period of forty-five to seventy-five minutes. It is possible that Saddington merely described experiments he knew were taking place elsewhere. Nevertheless, he never attempted to design a prototype process or practical application.¹⁰ It would take the demands of the Napoleonic Wars combined with empirical experiments in France to culminate in a practical end and the genesis of modern methods of canning.

The tin can was a technology born in time of war that eventually revolutionized food preservation, thereby affecting the diet of millions of people. Canning is the process of food preservation utilizing a tin can, while can-making or can manufacturing is the process of production for the tin can. The principle for all methods of food preservation is to develop conditions within a food which are "unfavorable for the growth of spoilage mechanisms."¹¹ In the case of canning, the primary principle "is the

¹⁰ Hedges, *Tin in Social and Economic History*, 152-153.

¹¹ American Can Company, *The Canned Food Reference Manual* (New York: American Can Company, 1939), 13-14.

application of heat in the proper degree for a sufficient time to cause sterilization in a closed container."¹² It was a superior method from former food preservation technologies because the vessels could be transported further and the contents preserved longer.

In 1795, during the French Revolution and wars of Napoleon, the French Society for the Encouragement of New Inventions, a department of the Ministry of the Interior, offered a prize of 12,000 francs for a practicable method of food preservation. The stipulations for the prize were that the method of preservation had to be validated by the Society, and the winner had to publish their findings so that, in the spirit of French Revolutionary universalism, the general public could benefit from the dissemination of useful information. The practical concern of the Society was providing the French Navy with provisions they could carry with them on deployments, rather than depending upon foreign ports which were often blockaded by enemies of the nation.¹³

Additionally, the diet of sailors was quite poor and consisted of salt pork and beef, dried fish, cheese, flour, dried beans and peas, oatmeal, and beer, wine, or rum. It was a diet heavily laden with salt, lacked enough fresh water -- a very precious commodity at sea -- and it did not preserve well during long voyages. Sailors suffered from scurvy and the resultant swelling of limbs and gums from what we now know as resulting from the lack of vitamin C. A better method of food preservation was an absolutely necessity to keep

¹² A. W. Bitting and K. G. Bitting, *Canning and How to Use Canned Foods* (Washington, D. C.: National Capitol Press, 1916), 15.

¹³ Charles B. Kuhlmann, "The Processing of Agricultural Products in the Pre-Railway Age" in *The Growth of the American Economy*, ed. Harold F. Williamson, (New York: Prentice Hall, 1944), 201.

fleets sailing the seas for long periods of time.¹⁴

In 1809 the prize was awarded to Nicolas Appert, a confectioner, pickler, wine-maker, brewer, chef, distiller, and army contractor.¹⁵ Appert was born in 1750 in Chalons-sur-Marne, France and died at his estate and factory in Massy, France in 1841. He served an apprenticeship as a confectioner and established a business in Paris by 1780. He began his preservation experiments while operating his confectionary business, but his efforts seemed so promising that he shuttered his confectionary in 1795 to concentrate on his process of food preservation. Appert had no scientific training and his process of experimentation was characterized by trial-and-error. His process used sealed glass jars submerged in a bath of boiling water for various periods of time, depending upon what was being packed. Appert had been working on this process for many years and had sent his containers in small batches on many sea voyages with favorable results. He surmised there were two principles required for proper preservation. He had concluded from experimental observation that prolonged exposure of products to air was the root cause of spoilage. However, the application of heat could preserve food in sealed containers, thereby negating the effects of air and preventing spoilage. He had no knowledge of the modern science of bacteriology, but his empirical discoveries were "achievement enough," according to food historian Stuart Thorne.¹⁶ The intentions of his experiments were twofold: there were practical aims

¹⁴ Shephard, *Pickled, Potted, and Canned*, 201-210.

¹⁵ Swank, *The Story of Food Preservation*, 70-72.

¹⁶ Thorne, *The History of Food Preservation*, 28-31.

such as providing the military and hospitals with healthy foods, but he also entertained the idea of citizens consuming for pleasure and creating a new industry.¹⁷

One of the stipulations placed upon the prize by the Society was that the winner had to publish the findings, at his own expense, and forward 200 copies of his report to the Ministry of the Interior, prior to receiving the 12,000 francs. In 1810 Appert published *The Book for All Households or the Art of Preserving Animal and Vegetable Substances for Many Years* to satisfy the contingent conditions attached to the award and received the prize money on January 30, 1810. The work has three major sections. The first is a detailed description of the apparatus, materials, and process used for sealing the glass jars. According to Appert, he selected glass as the material for his containers because it was "the material most impervious to air" as he believed exposure to air the culprit behind product deterioration.¹⁸ Appert used specially manufactured wide-mouthed glass jars. He had initially used champagne bottles with a 3/4 inch opening, but later substituted the wide-mouth with a larger opening of 2 to 2 1/2 inches to allowing for ease of filling the food.¹⁹ The glass jars were sealed with a hand-cut cork

¹⁷ Alberto Capetti, "The Taste for Canned and Preserved Food" in *Food: A Culinary History from Antiquity to the Present*, ed. Jean-Louis Flandrin and Massimo Montanari, (NY: Columbia University Press, 1999), 494.

¹⁸ Nicolas Appert, *The Book for All Households; Or, The Art of Preserving Animal and Vegetable Substances for Many Years* (Paris: Patris and Company, 1810), translated by Katherine Golden Bitting (Chicago: Glass Container Association of America, 1920; reprint, Charleston, S.C.: Nabu Press, 2010), 15 (page citations are to the reprint edition). Appert's treatise was quickly an international sensation as it addressed the worldwide concern of improved methodologies for food preservation. The first English edition of Appert's work was published in London by Black, Parry and Kingsbury in 1811 and the first American edition in 1812 by D. Longworth of New York.

¹⁹ Jean-Paul Barbier, *Nicolas Appert: Inventuer et Humaniste* (Chicago: University of Chicago Press, 1994), 81-83.

and pressed for "three-quarters of their length by the vise."²⁰ Metal wires were run perpendicular to each other through the cork and then twisted around the cork. The final step in container preparation was sealing the cork and wires with quicklime and enveloping them in a burlap sack prior to submersion in the water-bath.

The second section of his treatise described the preparation and instructions for processing over forty types of meat, fish, dairy products, fruits, vegetables, nuts, and herbs. The final section included instructions for how to open the sealed containers and serve the preserved items.

His process was time consuming and expensive. The publisher's note to *The Book for All Households* warned "as these articles cannot be prepared in quantity, Messrs., the chefs for the admirals of the fleet and the staff, who desire to provision for long voyages are requested to make their orders in advance" and the prices were certainly not inexpensive, but "moderate."²¹ Nevertheless, the canning industry was born, with Appert recognized forevermore as the "Father of Canning."

Independent of Appert, the Englishman Peter Durand experimented with preserving food using a lighter container made of tin-coated iron and in 1810 received British Patent #3372 for it. There is no evidence Durand packed cans, but he did sell his patent rights to the English firm Donkin & Hall. The cost of tinplate containers was expensive, the production rate for these craft-made products was 10 cans per day by a single tinsmith; therefore, the firm's output of packed goods was small. It was

²⁰ Appert, *The Book for All Households*, translated by K. G. Bitting, 18.

²¹ *Ibid.*, v-vi.

imperative that the critical first customer have the financial wherewithal to pay the relatively high price for the goods. That customer was the British government, and Donkin & Hall provided tinned rations to the British army and navy from 1812 to 1814. The products were primarily canned meats, fish, and some fruit preserves and jellies. Few vegetables were packed by Donkin & Hall. Later, with another partner named Gamble, the firm provided rations for early nineteenth-century polar expeditions, such as an 1820 journey to the Arctic.²²

Recent scholarship has questioned whether Peter Durand was actually the inventor of the tin can. Norman D. Cowell, an English food historian, claimed that the real inventor of the tin can was a Frenchman named Phillippe Girard. In Cowell's reinterpretation, Girard is the man responsible for marrying Appert's process of heat preservation with the tin can. The old notion was that Appert was the process inventor, Durand the person who conceived of preservation in tin rather than glass, and Donkin & Hall the firm that made the dual inventions a commercial success. Cowell contended that Girard should replace Durand in this chronology of invention for several reasons. First, Durand lived close to the Donkin & Hall cannery, so Cowell believed there was some type of collaboration between them on new processing technologies. Second, Durand had little mechanical knowledge to undertake a process of invention for a material object and was more of a marketer of ideas, goods, and services. Durand knew

²² Hyla M. Clark, *The Tin Can Book: The Can as Collectible Art, Advertising Art, and High Art* (NY: New American Library, 1977), 13; National Canners Association, *The Canning Industry: Its History, Importance, Organization, Methods, and the Public Services Values of its Products* (Washington, D. C.: National Canners Association, 1971), 5-8; Hedges, *Tin in Social and Economic History*, 154-156.

Girard from previous business relationships. Girard invented, patented, and displayed a lamp in 1806 which matched a Durand patent taken in 1811 on a similar lamp. Third, Girard was also in London in 1810, the same time as Durand wrote and received his patent for the tin can. Finally, Appert visited London in 1814 and expressed surprise that Girard, whom he knew from France, had received so little compensation from Donkin & Hall for his tin can, a process improvement described by Appert as "soldering so as to make tight by metallic security preserves in tin; and then varnish about with a brown varnish." Cowell concluded that Durand was a middleman or mouthpiece for Girard's inventions. Cowell believed Girard entered into the arrangement with Durand because he needed money. The patents were taken out in an English, rather than a French name, owing to the Napoleonic Wars. Appert also tried to distance himself from the English patents because he did not want to be politically associated with a process aiding the enemy navy. As the crowning piece of evidence for Girard's credibility as the architect of the tin can, Cowell cited Appert's 1831 version (4th edition) of *The Book for All Households* in which Appert acknowledged Girard rather than Durand as the inventor of the tin can.²³ Cowell presented a compelling argument for Girard, but his contention has received very little additional scholarly support. Even if Durand was tangentially involved with the process of invention for the tin can and merely a "middleman," he certainly married the tin can and Appert's process improvement into a commercially viable food preservation technique at Donkin & Hall.

²³ Norman D. Cowell, "Who Introduced the Tin Can? -- A New Candidate," *Food Technology*, Vol. 49, No. 2 (December, 1995): 61-64.

Canning arrived in America several decades after its inception in Europe. In 1817, Englishman William Underwood arrived in New Orleans from England after serving an apprenticeship in pickling. Underwood began a slow trek northward on foot from New Orleans with stops in Baltimore and New York, finally arriving in Boston in 1819. Underwood saw Boston as an attractive market for sterilized food in glass containers. He stated that in Boston "the rapidly increasing population appeared to offer opportunities to a food preserver." He established a firm in 1821, William Underwood and Company, which specialized in pickles, ketchup, sauces, fruit jams, and jellies, for primarily export markets in the West Indies, South America, and Asia. Underwood also packed milk, lobster, salmon, various fruits, and tomatoes for his local clients. His method for preservation was similar to Appert's: imported glass jars with cork tops to seal the jar held in place with wires. The bulk of Underwood's products, however, were exported as they were greeted with some suspicion by Americans since they were not imported.²⁴

At nearly the same time as Underwood, Thomas Kensett and his father-in-law Ezra Daggett, both Englishmen trained in the art of food preservation, began canning oysters, lobsters, and fish in New York City. In 1825, Thomas Kensett was awarded the first American patent for improved preserving by using "vessels of tin."²⁵ Kensett moved

²⁴ Earl Chapin May, *The Canning Clan: A Pageant of Pioneering Americans* (NY: The Macmillan Company, 1937), 2-10; W. Lyman Underwood, "Incidents in the Canning Industry of New England" in *A History of the Canning Industry By Its Most Prominent Men*, ed. Arthur I. Judge (Baltimore: National Cannery Association, 1914), 12.

²⁵ May, *The Canning Clan*, 10-11. The original 1825 patent for Kensett's tin can does not exist at the U. S. Patent Office. More than two-thirds of patent records were destroyed in an 1836 fire.

his business to Baltimore in 1839 to take advantage of the ready accessibility of oysters, crabs, and fish, plus the availability of a wide variety of fruits and vegetables from the local community. He opened his first cannery in Baltimore in 1840 and the city began a long history of being the preeminent site for can-making and canning in nineteenth-century America. Soon after his move to Baltimore, Kensett began using tin rather than glass when the costs and lack of supply for imported glass containers made the switch to a tin can an economic imperative.²⁶ Glass had the drawback of being extremely breakable, while tin allowed easier transport and durability of finished products. Additionally, tinplate was less expensive than glass, even though tinplate was imported. From his trials using tin canisters, soon shortened to tin cans, Thomas Kensett "might fairly be called the father of the can manufacturing industry in the United States."²⁷

Food preserved in tin cans was still quite expensive, however, even with the switch from imported glass jars. The 1850 price list from Samuel Harrison Bingman, a Laurelton, Pennsylvania tinsmith, substantiates the high cost of hand-made cans. A fruit can listed for \$0.25, while other types of cans sold for up to \$0.29 each. These were prices for just the can, which still had to be filled, sealed and preserved, and transported to the point of use. There were not many Americans who could partake of Appert's or Kensett's innovative technology.²⁸ Tin cans were accepted and used by pioneers,

²⁶ James H. Collins, *The Story of Canned Foods* (NY: E. P. Dutton and Company, 1924), 8-12.

²⁷ Can Manufacturers Institute, *The History of the Metal Can and its Service to Man* (Washington, D.C.: Can Manufacturers Institute, 1960), 4-5.

²⁸ Jeannette Lasansky, *To Cut, Piece, and Solder: The Work of the Rural Pennsylvania Tinsmith; 1778-1908* (University Park: The Pennsylvania State University Press, 1982), 30. The value of \$1 in 1850 is worth \$28.06 in 2014, so the \$0.25 - \$0.29 cost of a tin can in 1850 would be \$7.02 to \$8.14 today -- quite

settlers, miners, and the federal government. This select group of consumers lived in circumstances where canned food was regarded as a necessity, despite the cost. The California Gold Rush in 1849 spurred demand for canned goods, and miner's new-found wealth enabled them to pay the exorbitant prices.²⁹ The general public regarded foods preserved in cans as extravagant novelty items due to their expense. Baltimore packed oysters were the first luxury food to be nationally distributed.³⁰

Canning became firmly centered on the east coast during the 1820s to 1840s. The nascent operations of Thomas Kensett eventually made Baltimore the center of East Coast canning and it would remain the most important center of the industry for the balance of the nineteenth century. Baltimore had many advantages over other locations. First, as a port city, it could provision ships, distribute to other areas, and also serve as an entrepot for imported Welsh tinplated iron and steel, as there was no American tinplate industry at the time. Second, it had a plentiful supply of seafood, particularly oysters and crab, readily available in the Chesapeake Bay. However, inland parts of Maryland were also important providers of fruits and vegetables, particularly tomatoes and peaches. Finally, Baltimore had an abundant supply of labor to work in the canneries. The plentiful labor supply was due to immigration and also migration from southern states. By 1850, there were five canneries operating in Baltimore, a little

expensive! http://www.minneapolisfed.org/community_education/teacher/calc/hist1800.cfm (accessed April 21, 2014).

²⁹ CMI, *History of the Metal Can*, 1960, 7.

³⁰ Collins, *The Story of Canned Foods*, 12.

over a decade from the first establishment by Kensett.³¹

By the 1850s, Philadelphia was another important coastal city that had a thriving industry, although not as large as Baltimore's. In 1855 a Philadelphia canner and can-maker named Mills B. Espy reported packing ten tons of cherries, five tons of strawberries, 10,000 baskets of peaches, tomatoes, and pears, as well as "thousands" of bushels of various other vegetables.³²

The canning industry eventually moved away from the coast for the packing of fruits, vegetables, and berries. In addition to Baltimore, there were two other important centers for canning on the East Coast. Corn was raised in inland Maine in the 1840s and transported by barge to the coast for canning. The brothers Isaac and Nathan Winslow opened the first cannery in Portland, Maine in 1842. While they packed some fish and lobster, their major product was corn. They even developed a line of corn cutting devices designed to strip the kernels from the cob. Maine became known for a specialty type of creamed sweet corn, known nationally as "Maine Style" corn to distinguish it from non-creamed varieties produced elsewhere. The other important interior region for canning was Oneida County, New York, located east of Syracuse. Close to the product to be packed, the Oneida County canneries were small scale and distributed throughout the region. Specialties were corn, apples, and various types of berries for jams and jellies. While Oneida County was the hub of activity in New

³¹ Edward F. Keuchel, "Master of the Art of Canning: Baltimore, 1860-1900," *Maryland Historical Magazine*, Vol. 67, No. 4 (Winter, 1972): 352-355.

³² Richard Osborn Cummings, *The American and His Food* (NY: Arno Press, 1970), 67.

York State, there were canneries located throughout central New York as far west as Rochester.³³

Canneries began on the west coast in California shortly after the 1849 Gold Rush. Canned goods were already expensive, but the added transportation cost to ship them from the East Coast around the tip of South America or across the Panamanian Isthmus made their cost excessive, even for the new wealth provided by gold. The founders of the California industry were Francis Cutting and Dan Provost. Cutting and Provost were dry goods merchants in San Francisco who recognized that the canning of locally available fruits, peaches being their main product, was a potential windfall. In 1856 they established their cannery in San Francisco and began making cans and packing them with various fruits. A few years later, William Hume, a native of Maine, along with his brothers John and George, began fishing for salmon on the Sacramento River. Their business was so successful, that they encouraged another friend from Maine, Andrew Hapgood, to join them and invest in their operation. Hapgood had experience canning lobster in Maine, and in 1863 the partnership opened the first salmon cannery in California. Salmon canning eventually moved up the Pacific coast to Washington State and Alaska by the 1870s.³⁴ Salmon canning remained much more important to the California economy than fruit packing until the late nineteenth century.

³³ May, 15-16; Edward F. Keuchel, "The Development of the Canning Industry in New York State to 1960" (Ph.D. diss., Cornell University, 1960), 27-32.

³⁴ Clark, *The Tin Can Book*, 13-14; Swank, *The Story of Food Preservation*, 73-74; Kuhlmann, "The Processing of Agricultural Products," 202; Isidor Jacobs, "The Rise and Progress of the Canning Industry in California," in *A History of the Canning Industry*, ed. Judge, 30-31; W. I. Crawford, "The Development of the Salmon Canning Industry," in *A History of the Canning Industry*, ed. Judge, 46-47.

In the period before the Civil War, the canning industry began a slow migration into the Midwest. By 1860 there were facilities for packing fruits and vegetables in Indianapolis owned by Gilbert Van Camp and a cannery in Cincinnati operated by Thomas Duckwall. In comparison to the larger canneries in Maine, Baltimore, Philadelphia, and New York State, these were very small operations and mere outposts for the industry. The boom in Midwest canning would not occur until after the Civil War, but Duckwall and Van Camp would become important promoters. The most significant products in the Midwest were corn and peas, products that would eventually typify the region bounded by Wisconsin and Michigan in the north and as far west as Iowa and Illinois.³⁵ In summary, prior to the Civil War the canning industry was centered on the East Coast with Baltimore as the hub, yet had spanned the continent making inroads in the Midwest and California. These latter two regions would become centers of import for growth, consumption, and technological development post-Civil War.

There were four other developments for canning and can-making which were significant for the growth of the industry prior to the Civil War. Two developments were scientific in nature, while the other two were the product of independent inventors. The basis of the canning industry had been empirical trial-and-error from the time of Appert. The "Father of Canning" properly recognized that heat applied to products would preserve them, but he did not realize that boiling was not hot enough to sterilize all products. Immediately prior to the outbreak of the Civil War, the first application of

³⁵ May, *The Canning Clan*, 79; Kuhlmann, "The Processing of Agricultural Products," 202-203.

science to the art of canning was made by the famous chemist Sir Humphrey Davy. Earlier in 1808, Davy added calcium chloride or salt to water, thereby raising the boiling point from 212° to 240° Fahrenheit. After a passage of over fifty years, his discovery was finally applied in canning. In 1861, Isaac Solomon of Baltimore used Sir Humphrey Davy's 1808 discovery at his cannery and raised the boiling point of his hot water bath to 240° Fahrenheit by adding calcium chloride, thus reducing the cooking time of canned products because they were immersed in hotter water. The average cook time decreased from six hours to twenty-five minutes, thereby increasing throughput by a factor of over twelve. While Solomon's application of Davy's discovery did allow canners to produce more product, the calcium chloride had a deleterious effect on the tin cans; the exteriors often corroded unless properly washed after the hot water bath. It would take the discovery of the steam retort, or pressure cooker, in the 1870s, to eliminate the problem of corrosion stemming from the calcium chloride water bath.³⁶

Research in basic science also played an important role prior to the Civil War. Appert believed exposure to air was the key to spoiled food, therefore exclusion of air was of utmost importance. In the 1860s, Louis Pasteur began his pioneering studies of bacteriology and applied it to canning. Pasteur hypothesized that microscopic bacteria were the cause of goods spoiling inside cans and could be killed through the application of heat. He proved that the microbes were the root cause of decay, spoilage,

³⁶ Clarence Francis, *A History of Food and Its Preservation: A Contribution to Civilization* (Princeton: The Princeton University Press, 1937), 9-11; A. W. Bitting and K. G. Bitting, *Canning and How to Use Canned Foods*, 16; Hugh S. Orem, "Baltimore: Master of the Art of Canning," in *A History of the Canning Industry*, ed. Judge, 9-10.

fermentation, and disease in canned goods. He sought to identify the organisms, determine their resistance to heat and acidity, establish how much heat would kill them, and define adequate processing times at specified temperatures for specific foods. Much of the definition of processing times would be done by others, as almost thirty years would elapse before his science was applied to canning. Pasteur's work would not be put to use until the 1890s when scientists at MIT and the University of Wisconsin applied Pasteur's science to canning.³⁷

The most important contribution to the growth and mass appeal of canning and tin cans in America, prior to the Civil War, is attributed to Gail Borden. This independent inventor was raised in New York State, but migrated to Texas. As a result of his experiences on the frontier in Texas, Borden believed there was a need to provide a reliable food source to westward-bound pioneers and explorers. He also believed the military and merchant ships needed preserved foods which would keep nearly indefinitely. In the late 1840s and early 1850s Borden worked to create a meat biscuit for which he received a U. S. patent in 1850. The process required the meat to be boiled until the liquid and solid portions separated. The solid portions were discarded, and Borden then evaporated the broth until it reached the consistency of syrup. Eleven pounds of meat would yield one pound of broth. The concentrated liquid was mixed with flour and baked in loaves weighing four pounds. His invention won a Gold Medal at the 1851 Crystal Palace Exhibition in London, along with five other U. S. entries,

³⁷ National Canners Association, *The Story of the Canning Industry* (Washington, D.C.: National Canners Association, 1948), 4; Swank, *The Story of Food Preservation*, 75-77.

including Colt's revolver and McCormick's reaper. Fresh off his success in London, Borden began trials with the U. S. Army in the early 1850s. Initially, the Army, hampered by long supply trains, believed the meat biscuit complemented the high degree of mobility required on the western frontier. However, the field trials in 1851 were less positive, and the meat biscuit was seen as innutritious, unpalatable, and nauseating. There were unsubstantiated charges by Borden that the meat packing companies had colluded with the military, but soldiers simply did not like the taste of the Gold Medal winning biscuit.³⁸

Despite his lack of financial success with the meat biscuit, Borden's invention of condensed milk became a veritable gold mine. The myth behind the genesis of Borden's idea was that on his return trip from London in 1851, the seas were very stormy and the cows below deck could not be milked. Babies were crying out for milk, and Borden yearned for an invention which would feed the starving babies. The truth is that Borden believed passionately in evaporation as a processing method for food containing large amounts of water. Borden developed a process using a vacuum pan for condensing milk, without adding sugar, as was the previously accepted practice for long term preservation of milk. Borden spent much of the early and mid-1850s promoting the novelty of his process for milk and made three patent applications. He was finally successful in 1856 when he convinced the U. S. Patent Office of the superiority of his process for condensing milk using a vacuum. Gail Borden was awarded U. S. Patent

³⁸ Joe B. Frantz, *Gail Borden: Dairyman to a Nation* (Norman: University of Oklahoma Press, 1951), 201-221.

15,553 on August 19, 1856. He made four major claims in his application. First, condensing with a vacuum preserved the quality of the milk. Borden stated that, "the nature of my discovery and invention consists in concentrating milk in a vacuum-vessel out of contact with the atmosphere, to prevent the incipient decomposition, or any hurtful change in the constituent elements of the milk during the process of evaporation." Second, he claimed his milk could be a reliable food source many months after evaporation because he immediately placed it in "hermetically-sealed . . . canisters [tin cans] . . . for long-keeping." Third, he was the first to preserve milk without the addition of sugar, and he argued "it is rendered preservative and soluble without the use of sugar or any antiseptic, which has not, to my knowledge, ever been effected before." Finally, his invention lowered the price of evaporated milk and made it affordable for more people "for less than half the price at which other concentrated milk has usually been sold."³⁹ In other words, Borden evaporated milk, without adding costly sugar, through the use of a vacuum that excluded air, thereby preserving the nutritional properties of the milk and providing a product inexpensive enough for mass appeal.

Borden required financing to commercially capitalize on his invention. He received the financial backing of Jeremiah Milbank in the late 1850s and opened factories in Burrville, New York and Litchfield, Connecticut between 1858 and 1860. He poured his concentrated milk into one quart tin cans. The final consumer of each tin of

³⁹ Ibid., 223-229; Gail Borden. 1856. Improvement in the Concentration of Milk. U. S. Patent 15,553, filed June 12, 1856 and issued August 19, 1856.

milk then mixed it with four to five quarts of water for a "rich milk." The initial order for condensed milk from the Union Army came in 1860 and was for 500 pounds. The Army believed Borden's milk was an acceptable substitute for fresh milk and a product which could sustain the long distances and extreme conditions of the battlefield. During the course of the Civil War, demand always exceeded supply for condensed milk. Soldiers returning home on furlough told stories of a canned milk that was clean, refreshing, and preserved nearly indefinitely. Borden's condensed milk would become a favorite specialty item purchased by soldiers, primarily Union, during the War. Throughout the course of the Civil War and immediately thereafter, between 1862 and 1866, Borden opened plants in Baltimore, Maryland; York, Pennsylvania; Brewster, New York; and Elgin, Illinois.⁴⁰ The Civil War was a turning point for condensed milk and a milestone for the acceptance of food in tin cans.

Gail Borden created a canned product in the 1850s with the potential for mass appeal, but there was still no reliable and safe method for opening a tin can until the eve of the Civil War. The bayonet, from Bayonne, France, was designed as a weapon, but doubled as a can opener. Soldiers, sailors, explorers, miners, and pioneers had to attack tin cans with knives, bayonets, or a hammer and chisel. There were even reports of soldiers and sailors using rifle fire to open tin cans.⁴¹ Most certainly the wealthy, dining on a meal of canned Baltimore oysters, did not resort to such uncivilized methods

⁴⁰ Frantz, *Gail Borden*, 233-263.

⁴¹ Henry Petroski, "Form Follows Failure," *American Heritage of Invention and Technology*, "Vol. 8, No. 2 (Fall 1992), 56-57; Earl Lifshey, *The Housewares Story: A History of the American Housewares Industry* (Chicago: National Housewares Manufacturers Association, 1973), 323-324. Lifshey's work includes a brief history of can opener development in the nineteenth and twentieth centuries.

for opening tin cans and left this chore to their servants. These rudimentary methods were eventually superseded by the first can opener invented by Ezra Warner of Waterbury, Connecticut in 1858. Warner was issued U. S. Patent 19,053 on January 5, 1858. The invention of such a device is an indication of the growing popularity and prevalence of tin cans. Warner's can opener operated on lever-action and consisted of a handle, piercer bar, and swiveled curved cutter (see figure 2.1). The user pierced the can at the desired spot and, using the point made by the piercer bar operating as a fulcrum, inserted the cutter on the outer edge of the can. The action of working the handle up and down opened the can, allowing the operator "to cut as fast as he can move his hand." Warner claimed that his "improvement over all other instruments for this purpose [opening cans]" was the "smoothness and rapidity of the cut." He also claimed his device was so simple "a child may use it without difficulty, or risk." He concluded by saying the ease of replacing the curved cutter without damaging the rest of the tool saved the user "much expense."⁴² There would be improvements on Warner's basic design in future years, but his can opener was used during the Civil War and provided soldiers and civilians alike a reliable and safe method to open cans.

⁴² Ezra J. Warner. 1858. Instrument for Opening Cans. U. S. Patent 19,063, issued January 5, 1858.

*E. J. Warner,
Can Opener,
No 19,063,
Patented Jan. 5, 1858.*

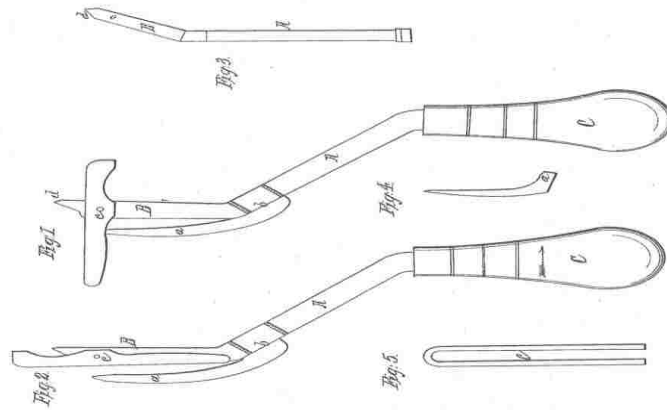

Figure 2.1 - Diagram of Ezra Warner's Can Opener. U. S. Patent and Trademark Office, Patent # 19,063, January 5, 1858.

The United States Military and the Tin Can

On the eve of the Civil War, food preservation using tin cans was still a very immature market. Annual production and consumption has been estimated at 5 million units by 1860.⁴³ There were signs of technological and scientific progress, however,

⁴³ There is no U. S. Census data available on annual production and consumption of tin cans prior to 1870. Various sources have estimated the figure of 5 million and this has become a historically accepted fact. See Collins, *The Story of Canned Foods*, 15-17; Boorstin *The Americans: The Democratic Experience*, 316; Jane Busch, "An Introduction to the Tin Can," *Historical Archaeology*, Vol. 15, No. 1

despite the small size of the industry. There was interest in tin cans and canning as food preservation technologies, but the cost of the product was beyond the means of most Americans, except the wealthiest. The most popular items were oysters and other seafood products, primarily packed on the eastern seaboard. However, the invention of a product with the potential for affordability and mass appeal, Borden's milk, and a device for opening the can, Warner's can opener, were significant technological milestones. Increasing factory throughput by the addition of calcium chloride to water baths, discovered by Davy and applied by Solomon, promised to increase supply. Canning science was also at an incipient stage prior to the Civil War and would not be systematically applied for decades, but Pasteur's studies in bacteriology were a propitious step away from trial-and-error experimentation. The Civil War would see the diffusion of the tin can not only as a novel food source, but as a ubiquitous and ever present item in the lives of soldiers and civilians alike.⁴⁴

(1981), 97; Brooke Hindle and Steven Lubar, *Engines of Change: The American Industrial Revolution, 1760-1860* (Washington, D. C.: The Smithsonian Institution Press, 1986), 105.

⁴⁴ The tin can, despite its eventual importance, has largely been ignored by historians of technology as an innovation initially adopted for large-scale use by the military. The evolution and acceptance of canned rations have received only slightly more attention from military historians. This study aims to interject the tin can into both the history of technology and military history. The history of technology field is replete with examples of military adoption of technologies before they were commercialized for civilian application. One excellent work that surveyed the early military adoption of well-known technologies such as the airplane, gyroscope, radio, electronic control mechanisms, and atomic energy is Thomas P. Hughes, *American Genesis: A Century of Invention and Technological Enthusiasm, 1870-1970* (Chicago: University of Chicago, 1989), 96-137, 381-442. Two military histories which discuss the influence of technology upon changing battlefield tactics and strategy, yet only contain passing references to canned food, are Bernard and Fawn Brodie, *From Crossbow to H-Bomb: The Evolution of the Weapons and Tactics of Warfare* (Bloomington: Indiana University Press, 1962), 107 and J. F. C. Fuller, *Armament and History: The Influence of Armament on History from the Dawn of Classical Warfare to the End of the Second World War* (London: Charles Scribner's Sons, 1945. Reprint, New York: DeCapo Press, 1998), 123, 131-132. The role of the United States military in the development of systems of production are superbly chronicled in Merritt Roe Smith, *Harpers Ferry Armory and the New*

The United States military, both Army and Navy, were the key American institutions to popularize the large-scale use of canned foods in the middle to late nineteenth century. The military use of tin cans did not necessarily lower the cost of canned goods, but they helped immeasurably to create conditions for the growth of canning and can-making post-Civil War. Growth of the industry in terms of quantity packed, geographic expansion, and development of technology were all a product of the Civil War and the increasing familiarity of Americans with the tin can as a method of long-term food preservation. The Civil War spurred increased demand for the tin can and facilitated diffusion and improvement of many earlier mechanical innovations.⁴⁵

Thus, while the Civil War itself was not the technical initiator of change in canning and can manufacturing, it very much did facilitate the diffusion of many developments already in process. In the words of historian Mark Wilde, "all of the changes that appeared in the wind in 1860 were hurried along by the Civil War,"⁴⁶ which it did in three important ways. First, the Civil War would expand the geographical

Technology: The Challenge of Change (Ithaca: Cornell University Press, 1977) and David A. Hounshell, *From the American System to Mass Production: The Development of Manufacturing Technology in the United States, 1800-1932* (Baltimore: Johns Hopkins University Press, 1984), 15-65.

⁴⁵ Numerous historians have emphasized the importance of the Civil War as a turning point for the popularization of the tin can. See in particular Boorstin, *The Americans: The Democratic Experience*, 315; Singer, *A History of Technology*, Volume 5, 42; Clark, *The Tin Can Book*, 15; Ed Kee, *Saving Our Harvest: The Story of the Mid-Atlantic Regions' Canning and Freezing Industry* (Baltimore: CTI Publishing, 2006), 16. Kee contended that "as canned products were used in the war, people on the home front became better acquainted with this new source of food as well. The war experience with canned foods resulted in America's growing confidence and acceptance of the products." Current industry advocate and lobbying groups, such as the National Canners Association and the Can Manufacturers Institute, also agree that the Civil War provided critical momentum to the canning and can manufacturing industries. See specifically NCA, *The Story of the Canning Industry*, 3 and CMI, *The History of the Metal Can*, 20. The CMI booklet stated that "the Civil War . . . did much to overcome prejudices against canned food, prejudice being a luxury a hungry fighting man could scarcely afford."

⁴⁶ Wilde, "Industrialization of Food Processing in the United States, 1860-1960," 22.

reach of the industry, at least in the North. Canning was already firmly established along the eastern seaboard and had begun on the west coast. It was also making a few inroads into Ohio, Indiana, and Illinois. Canning had not gained much of a foothold in the South and would not until later in the nineteenth century. By the end of the Civil War, there would be canneries in nearly every Union state. Second, throughput expanded somewhat, principally by Solomon's addition of calcium chloride to hot water baths, greatly increasing the quantity of goods available. Unquestionably, without this innovation, canned goods availability and their resulting popularization would have been greatly reduced. Finally, technological improvements such as Warner's can opener and Borden's condensed milk provided a technology and a product which were amenable to mass production and consumption. These innovations were the precursors to mechanical devices which proliferated post-Civil War.

The principal effect of the Civil War was to increase demand for canned foods due to experience and familiarity with the product gained throughout the course of the War. The tin can was ubiquitous and pervasive in Civil War campsites. It was obviously a technology for feeding soldiers and sailors and preserving food, but empty tin cans were also articles of great utility, such as containers for boiling coffee over a campfire. Coffee was essential to army life and central to life in camp. Soldiers would often carry their coffee and sugar ration mixed in a cloth bag ready for immediate use. According to the Civil War historian Bell Irvin Wiley, the Union soldier would "bring water to a boil in pint dippers or tin cans rigged with wire bails and then dump in the mixture and let it

boil until the desired hue was obtained. As a general rule, the longer a man served, the darker he liked his coffee."⁴⁷ John D. Billings, an artilleryman in the Tenth Massachusetts Battery, wrote in his memoir *Hardtack and Coffee* (1887) that "a recruit would afterwards be seen with his pint or quart preserve can, its improvised wire bail held on the end of a stick, boiling his coffee at the camp-fire, happy in the security of his ration from Jonahs [perpetually clumsy soldiers] and other casualties."⁴⁸ Tin cans were also used as contrivances and ornamentation to make camp shelters more habitable. In the winter of 1864, while encamped in winter quarters outside Brandy Station, Virginia, Captain Elisha Hunt Rhodes of the Second Rhode Island Volunteer Infantry noted the extreme comfort of his quarters. He said that "inside we have a fireplace and tin reflectors for candles on the walls. A chandelier made from old tin cans, or the tin taken from cans is in the centre."⁴⁹ Rhodes kept the tin can chandelier as a souvenir after the war. The fact that tin cans were used as articles for cooking and campsite decoration indicates how this technology had permeated the social structure and life of military units. The vast majority of Civil War soldiers were volunteers and returned to civilian life shortly after they were mustered out of service. This cadre of citizens familiar with canned foods would be an important diffuser of the technology.

Canned products were specialty items in the Civil War, not part of the regular Union Army ration. The agency responsible for provisioning soldiers was the

⁴⁷ Bell Irvin Wiley, *The Life of Billy Yank: The Common Soldier of the Union*, 1952 (Baton Rouge: Louisiana State University Press, 2008), 240-241.

⁴⁸ Billings, *Hardtack and Coffee*, 129.

⁴⁹ Robert Hunt Rhodes, ed., *All for the Union: The Civil War Diary and Letters of Elisha Hunt Rhodes* (NY: Vintage Books, 1992), 131.

Commissary Department, often just referred to as the Commissary. This agency reported to the Quartermaster Department, commanded by the Quartermaster General. The Quartermaster General reported directly to the Secretary of War and the mission of his agency was "to ensure an efficient system of supply" and specifically "to provide good and sufficient store houses for all military supplies, and for all provisions deposited by the Commissary's Department, or under contract between individuals and the Government."⁵⁰ The United States government did purchase canned goods through the Commissary Department, but they were not issued to enlisted soldiers as part of their food allotment. The Civil War ration for the Union Army consisted of the following daily allowance per soldier:

- twelve ounces of pork or bacon, or, one pound and four ounces of salt or fresh beef
- one pound and six ounces of soft bread or flour, or, one pound of hard bread [hardtack], or, one pound and four ounces of corn meal
- four ounces of a combination of beans, peas, rice, or hominy
- five ounces of potatoes
- one and three eighths ounces green coffee, or, one and a quarter ounces roasted (or roasted and ground) coffee, or, a quarter ounce of tea
- two and a half ounces sugar
- three quarters of an ounce of salt
- teaspoon of pepper
- tablespoon of molasses
- four ounces of whiskey "in cases of excessive fatigue, or severe exposure"⁵¹

⁵⁰ United States War Department, *Regulations for the Quartermasters Department of the United States Army* (Washington, D.C.: A. B. Claxton and Company Printers, 1838), 3.

⁵¹ United States War Department, *Revised United States Army Regulations of 1861 with an Appendix Containing the Changes and Laws Affecting Army Regulations and Articles of War to June 25, 1863* (Washington, D.C.: GPO, 1863), 244-247.

This diet was heavily dependent upon carbohydrates and protein, using salt as a preservative. It was monotonous, innutritious, and lacked important vitamins. There was a paucity of fruits and vegetables, so later in the war, onions were added to the daily ration, as well as a product named "desiccated vegetables." This product consisted of chopped and dried vegetables, compressed into a block. The block was reconstituted upon immersion in water and a portion distributed to soldiers or added to a soup.

Not surprisingly, soldiers were displeased with their unappetizing rations and had names for some of the products. The hardtack portion of the ration garnered the most derision. The favorite nicknames for this almost indigestible hard bread were "teeth dullers" or "sheet iron crackers" to denote the dense nature of the product. Some soldiers thought the hardtack so tough that it could act as armor plating. Hardtack often became moldy and infested with worms, so the monikers "worm castles" or "Lincoln pies" were also favorites. Salt pork was commonly known as "sowbelly," regardless of which portion of the anatomy was served, and the beef was called "salt horse" or "old bull." Attempts to add dried vegetables met with little acclamation by soldiers and the brick-like product was commonly referred to as "desecrated vegetables" or "baled hay."⁵² With such obstacles to appetizing fare, soldiers resorted to foraging, vendors, or eating at the tables of local residents. There was a need and desire for more variety and taste in their diets.

Canned foods filled this role for some Civil War soldiers, and there were several

⁵² Wiley, *Billy Yank*, 237-240, 242.

methods by which soldiers could procure them: informally, semi-officially, and through formal Army subsistence channels. One method outside of Army distribution networks were packages sent from home. The most common distribution channels were from Northeastern communities to the Army of the Potomac and from the Midwest to units along the Mississippi River, Tennessee, Georgia, and various other locations. The packages, wooden shipping crates, were sent by family, friends, neighborhoods, and often entire local communities. The government transported them free of charge to the final destination. These senders of "kindly remembrance" spared little expense in supporting their men at the front and packed the boxes with expensive delicacies. Soldiers would send lists home of the items they desired, most often personal care products for repairing their shoes or clothes, and edible items to relieve the monotony of their government issued fare. According to John Billings of Massachusetts, "as would naturally be expected, articles for the repair and solace of the inner man received most consideration in making out such a list." A letter from home often preceded the box and described its contents, thereby creating a high degree of anticipation among the soldier and his unit mates with whom he would often share his largesse. Billings reported he received tin cans of condensed milk and preserves in one of these boxes. He also knew of a case where a soldier desired "some whiskey for his enjoyment," which was sent to him concealed in a tin can. However, when the box was inspected at higher headquarters to ascertain there were no spirituous beverages in the package and subsequently resealed, a nail was inadvertently driven through the can and the recipient

received an empty tin can.⁵³

Foraging for food has been a common method for soldiers to supplement their rations for centuries, and the Civil War was no exception. Private Henry B. Raylman of Pennsylvania reported foraging for alligators, oranges, lemons, figs, oysters, corn, sweet potatoes, nuts, and watermelon when stationed off the coast of South Carolina. He also purchased eggs from local sources, as well as shot game. In addition to foraging, Raylman also received food packages to supplement his rations. While garrisoned at Hilton Head Island, he received a box from home on May 2, 1863. He reported the package contained several items unobtainable in his environs, notably "canned preserves and a can of butter. They was [sic] nice."⁵⁴ Clearly, an inexpensive and common channel to familiarize Civil War soldiers with canned goods came in packages sent from home.

Soldiers could also purchase canned food from the semi-official regimental sutler, a combination dry goods vendor and grocer. While a civilian, he had to have a license and act in accordance with military regulations. He was a convenience store on wagon wheels and followed the movements of his unit with the mission of providing the soldier with what the army supply system did not, but at the soldier's personal expense. The sutler offered various sundries and non-military goods, such as paper, pens and pencils, sewing materials, uniform accoutrements, personal care articles, as well as food

⁵³ Wiley, *Billy Yank*, 231-231; Billings, *Hardtack and Coffee*, 218-219

⁵⁴ Henry R. Raylman, "Diary of Henry R. Raylman October 16, 1862 - August 6, 1863," p. 4-8, Spruance Library, Buck County Historical Society, Doylestown, Pennsylvania, MSC 788, Folder 18. Raylman was from Upper Makefield, Pennsylvania and served with Company G, 174th Pennsylvania Militia.

items. Union Army regulations stated that "every military post may have one Sutler, to be appointed by the Secretary of War. Troops in campaign, on detachment or on distant service, will be allowed Sutlers, at the rate of one for every regiment, corps, or separate detachment; to be appointed by the commanding officer of such regiment, corps, or detachment . . . subject to the approval of the general or other officer in command." The regulations further stated that there would be no tax on sutlers, no claim to army quarters, prices must be "visible and reasonable," there was to be no difference in prices whether on cash or credit, credit extended to enlisted soldiers was not to exceed one third of their monthly pay, accounts had to be settled monthly, and in the case of death of the soldier, any amounts owed would be deducted from the pay due the deceased individual.⁵⁵ Sutlers were not allowed to sell intoxicating liquors at risk of losing their license, and General Orders No. 35, February 7, 1863 specifically allowed canned food items, such as meats, oysters, fruit, and vegetables to be sold. Government authorities were aware of the monotony and nutritional inadequacy of the standard ration and used sutlers to supplement the soldiers' diet. Items available from the sutler included the popular condensed milk of Gail Borden, as well as luxury items like sardines and salmon, and the extremely unpopular "essence of coffee," an ersatz type of concentrated coffee substance. Major companies, such as Armour, Swift,

⁵⁵ United States War Department, *Revised United States Army Regulations of 1861*, 37.

Smithfield, Lea & Perrins, and Libby's, provided items ranging from canned meats, hams, sauces, and turtle soup, to a variety of fruits and vegetables.⁵⁶

The Civil War sutler, however, occupied contested space in the hearts of soldiers. On one hand they welcomed the variety of nearly unobtainable goods provided by the sutler; on the other they thought him a rascal and profiteer who charged exorbitant prices for his goods. Sutlers argued that they assumed the risks of destruction or capture of their goods without recompense from the government; therefore, the high prices were justified. John Billings had a more balanced perspective on sutlers. He said that "owing to the high prices which they asked the soldiers for their goods, the belief found ready currency that they were little better than extortioners." On the other hand, sutlers "filled a need recognized, long before the Rebellion" and that "no soldier was compelled to patronize him."⁵⁷ The high prices charged for canned goods made his wares unobtainable for many soldiers, but some individuals certainly had their first experience with tin cans courtesy of these controversial vendors.

An unfortunately common venue for soldiers to sample canned goods was while recuperating in a hospital. This was one of a few officially sanctioned uses for canned food during the Civil War. John Billings, ever the assiduous observer, noted that "canned goods were in very general use by commissioned officers and hospitals."⁵⁸ Army regulations provided that an officer who purchased for a hospital could expend the

⁵⁶ Francis A. Lord, *Civil War Sutlers and Their Wares* (NY: Thomas Yoseloff, 1969), 39-44, 133-135.

⁵⁷ Billings, *Hardtack and Coffee*, 227.

⁵⁸ *Ibid.*, 129.

Hospital Fund on additional items such as "food, solid or fluid, to be used for the diet of the sick, and not furnished by the Subsistence Department or Medical Department."⁵⁹ This was the regulation which permitted purchases of canned goods for hospitals and was based upon the belief that more nutritious foods than standard army rations were required to nurse the sick back to health. Medical officers were invested with authority and leeway not only in obtaining wholesome food for their hospitals, but were also responsible for ensuring the regular rations were satisfactory. The 2nd Brigade of the 52nd Regiment of Pennsylvania Volunteers was stationed at Morris Island, South Carolina from October 1863 until April 1864. Weekly inspections of the rations during this period were conducted by either the Brigade Surgeon, J. B. Crawford, or Assistant Brigade Surgeon, R. Sargent, plus one other commissioned officer. All the reports noted "no defect observed," "no defect or abuse noted," or "no deficiencies."⁶⁰ Despite their authoritative tone, these reports most likely failed to reassure soldiers about the healthfulness of the hardtack and salted beef they regularly consumed.

During the month of December 1863, Regimental Surgeon David McFalls of the 142nd New York Volunteers stationed at Kiawah Island, South Carolina purchased canned blackberries, peaches, jelly, and raspberry jam from the Regimental Sutler, William B. Earl, for use in the unit hospital. A small tin of raspberry jam cost 20 cents, a high price considering a Union private was paid \$13 per month. The receipt, a standard

⁵⁹ Unites States War Department, *Revised Unites States Army Regulations of 1861*, 248.

⁶⁰ Food Inspection Reports, The Davis Brigade, 2nd Brigade, 52nd Pennsylvania Volunteer Regiment, *The Pennebaker Collection*, Spruance Library, Bucks County Historical Society, Doylestown, Pennsylvania, MSC 255, Box 19, Folder 2.

Army form, specifically stated that Surgeon McFalls certified "on honor, that the above specified articles were purchased on my requisition for the use of the Hospital under my charge."⁶¹ Similarly, in March 1864, Lieutenant H. W. Locke, the commissary and subsistence officer for a unit stationed in Jacksonville, Florida, purchased four dozen cans of peaches and two dozen cans of tomatoes for the hospital he was responsible for supplying. Locke made these purchases from the Commissary Department.⁶² These additional rations were expensive, yet both officers used the provision in Army regulations stipulating they could purchase canned foods for the hospitals for which they were responsible using monies from the Hospital Fund. As troublesome as a stay in a hospital could be for a Civil War soldier, the more appetizing diet made possible by canned foods was a welcome introduction to tin cans for many.

The subsistence branch of the Commissary Department also stocked canned goods, but these were only distributed on rare occasions. The regular rations were issued in bulk units of measure, such as barrels, kegs, casks, and boxes. After General Ulysses Grant's Overland Campaign in May and June 1864, the Army of the Potomac besieged Richmond and Petersburg, Virginia. As the Union Navy had control of the inland waterways surrounding coastal Virginia, Grant established a major supply depot at City Point, Virginia with railroads connected to the trenches outside Petersburg and Bermuda Hundred, Virginia. Ration reports for stores received at City Point and

⁶¹ David McFalls to William B. Earl, December 31, 1863, Civil War Subsistence Stores Reports, "Civil War Documents," 3 Unnumbered Boxes, Pieklik Learning and Research Center, United States Army Quartermaster Museum, Fort Lee, Virginia.

⁶² H. W. Locke to Jacksonville, Florida Union Army Hospital, March 1864, "Civil War Documents," Fort Lee, Virginia.

Bermuda Hundred substantiate bulk purchases as common practice. On March 15, 1865 at City Point, Captain H. W. Locke, the commissary officer for the Army of the Potomac, issued 68 barrels of bacon, 105 barrels of beans, 38 barrels of coffee, 32 kegs of vinegar, 25 kegs of molasses, and 23 kegs of pickles.⁶³ Similarly, on March 18, 1865 at Bermuda Hundred, Captain Locke received 7 barrels of codfish, 165 barrels of flour, 12 barrels of dried apples, 15 barrels of onions, 20 barrels of brown sugar, and even 20 head of beef cattle.⁶⁴ Transport of bulk items was more economical and made distribution more efficient for the Army. In only two cases did the Commissary Department issue canned rations. The instances were special purchases from the "company fund" for use by enlisted soldiers and as provisions for the officer's mess.

Special purchases from the "company fund" were a rare, albeit possible channel, by which soldiers' experienced canned food. Early in the Civil War, Army regulations made provisions for a unit fund. The purpose was to "embrace savings from the economical use or management of the ration."⁶⁵ The Commissary Department would buy back rations saved by a unit at cost, except for molasses and desiccated potatoes or vegetables. The resultant difference would then be credited to the unit and available to purchase other items from the Commissary. The funds could be used to purchase greater quantities of standard fare, or luxury items normally unobtainable by the rank and file, such as canned goods. In theory this system created an incentive to

⁶³ Captain H. W. Locke to Captain George Ames, March 15, 1865, City Point, Virginia, "Civil War Documents," Fort Lee, Virginia.

⁶⁴ Receipt from R. Holmes to Captain H. W. Locke, March 18, 1865, Bermuda Hundred, Virginia, "Civil War Documents," Fort Lee, Virginia.

⁶⁵ United States War Department, *Revised United States Army Regulations of 1861*, 243.

economize, add variety to a soldiers' diet, and improve unit morale, but in practice it often failed. While there were likely some company commanders who used this system to provide for their troops, most seemed unaware of the regulations or did not want to be bothered by administration of the company fund. According to the seasoned campaigner John Billings, "I have yet to learn of the first company whose members ever received any revenue from such a source, although the name *Company Fund* is a familiar one to every veteran."⁶⁶

A more common method for consumption of canned food purchased through the Commissary Department was at an officers' mess. The officer's mess was an officer-only gathering of a regiment's leadership to eat and socialize. The Commissary stocked canned food for sale to officers because rations for them were not provided as part of their regular compensation, while rations were "free" for enlisted soldiers. Officers were given an allowance of money and it was their personal responsibility to provide sustenance for themselves. During the Civil War, officers would receive a monthly stipend for subsistence ranging from \$36 for lieutenants, captains, and majors, \$45 for a lieutenant colonel, and \$56 for a colonel.⁶⁷ Considering the monthly pay for a private soldier was \$13, these were very generous allowances. These monies were used to purchase food from local non-military sources, dine at private homes, or eat at an officers' mess. Often, the officers of a regiment would dine together with fare purchased from the Commissary Department. On July 29, 1865, Captain E. Lewis, a

⁶⁶ Wiley, *Billy Yank*, 225; Billings, *Hardtack and Coffee*, 112.

⁶⁷ Billings, *Hardtack and Coffee*, 112-113.

member of the 8th United States Colored Troops (USCT) and the adjutant (administrative officer) of the 2nd Brigade, 2nd Division stationed in Edinburgh, Texas, sent a letter to the local Commissary Department in Brownsville, Texas requesting supplies. Captain Lewis explained that the letter was an "estimate for subsistence stores required for sale to officers," and he beseeched the recipient of the letter to "oblige me by sending stores on this estimate as soon as possible as I am out of stores." The request was for some standard items, such as flour, tea, sugar, and smoked beef. However, it also included a request for "48 cans of peaches, 48 cans of milk, 24 cans of jelly, and 48 cans of tomatoes."⁶⁸ With generous subsistence allowances, it is little wonder many Civil War memoirs by enlisted soldiers regarded canned goods as the special preserve of officers due both to price and distribution.

The last instance in which soldiers experienced canned rations during the Civil War was when serving on a distant post. Although not part of the regular ration, canned goods were provided more liberally to soldiers stationed at distant posts than service at sites nearer to bases of supply. After the cessation of hostilities, Federal troops were sent to distant posts to disarm CSA units, capture recalcitrant rebels, restore order, and establish federal authority. As these posts were often difficult to supply owing to the lack of adequate and reliable transportation and the devastation and impoverishment of the countryside, Army regulations were relaxed and canned

⁶⁸ Captain E. Lewis to Captain H. W. Locke, July 29, 1865, Edinburgh, Texas, "Civil War Documents," Fort Lee, Virginia. The USCT were Union Army units composed of African American enlisted soldiers and commanded by white officers. Many of the enlisted soldiers were former slaves. By the end of the Civil War, slightly less than 10% of the entire Union Army was composed of African American soldiers.

goods were supplied on a somewhat more liberal basis to all soldiers. Captain H. W. Locke was sent west upon the conclusion of the war and was the depot commissary officer stationed in Brownsville, Texas. It was his responsibility to supply Federal units operating in Texas, and he estimated there were 17,000 persons to feed. On his ration inventory for August 5, 1865, Locke reported having 864 cans of tomatoes, 528 cans of milk, no jelly, and 496 cans of peaches. Most likely these were #2 cans, the most common size.⁶⁹ These were all listed under the heading "additional articles." Less than a week later, Locke reported receiving the following canned goods via steamship at his Brownsville post: 240 cans of tomatoes, 144 cans of peaches, and 288 cans of milk.⁷⁰ In September 1865, Locke received an additional 240 cans of condensed milk and on October 13, 1865 another steamer arrived with 67 cans of tomatoes, 96 cans of peaches, 334 cans of milk, and 252 cans of assorted jellies and jams.⁷¹ The ration reports and supply receipts indicate that canned goods were very prevalent on distant posts, particularly immediately after the Civil War. Under trying conditions of frontier service, many soldiers undoubtedly experienced canned food.

Canned food brought variety to the diet of a Civil War soldier which was undreamt of a mere fifteen years earlier during the Mexican War. Peaches, tomatoes, blackberries, strawberries, jams and jellies made from an eclectic collection of berries

⁶⁹ Report of Subsistence Stores on Hand by Captain H. W. Locke, August 5, 1865, Brownsville, Texas, "Civil War Documents," Fort Lee, Virginia.

⁷⁰ Receipt from Edward Coe to Captain H. W. Locke, August 11, 1865, Brownsville, Texas, "Civil War Documents," Fort Lee, Virginia.

⁷¹ Receipts for Stores by Captain H. W. Locke, September 1865 and October 13, 1865, Brownsville, Texas, "Civil War Documents," Fort Lee, Virginia.

and fruits, and condensed milk had become common items. Of all these items, canned milk was seemingly the most familiar and coveted item sought by Union soldiers. In extreme cases, pilferage was one unsanctioned method to obtain this precious item. Frank Wilkeson, a private serving with the 11th Battery of the New York Light Artillery, recalled one experience with canned milk. He and a wounded soldier were preparing a meal, and he said, "I had that day found a haversack - truth is that its owner, a heavy artilleryman, was asleep when I found it - which contained a can of condensed milk and half a loaf of light bread, the wounded soldier and I had a feast."⁷² Meat, seafood, and poultry were also available in tin cans. Elisha Hunt Rhodes recalled hosting a Fourth of July celebration with his fellow officers in the trenches outside Petersburg in 1864. In his memoirs he listed the menu, and it contained "stewed oysters (canned)" as well as "roast turkey (canned)" along with bread pudding, tapioca pudding, apple pie, lemonade, and cigars.⁷³ His emphasis on several of the items being canned accentuated the importance and significance of this special dinner. Coffee was even canned for use by the Army. Early in the war, the Commissary Department distributed an item known as "essence of coffee." It was made from a concentrated extract of coffee beans, mixed with sugar and milk, and packed in half gallon cans. According to one Union soldier, it had the consistency of "axle grease." A teaspoon of this product, mixed in hot water, produced a cup of coffee (see figures 2.2 and 2.3). However, soldiers much preferred

⁷² Frank Wilkeson, *Turned Inside Out: Recollections of a Private Soldier in the Army of the Potomac*, 1882 (Lincoln: University of Nebraska Press, 1997), 87.

⁷³ Rhodes, *All for the Union*, 158-159.

their ration of whole beans, and this ersatz coffee was soon discontinued as a ration item.⁷⁴ Despite the failure of this one canned item, the number of soldiers experiencing canned goods for the first time grew dramatically during the Civil War, and they returned from their service extolling the virtues of these revolutionary products.



Figure 2.2 - Civil War Era "Essence of Coffee" Tin Can, front view. Courtesy of the U. S. Army Quartermaster Museum, Fort Lee, Virginia.

⁷⁴ Wiley, *Billy Yank*, 241.



Figure 2.3 - Civil War Era "Essence of Coffee" Tin Can, reverse view. Note the English and German language instructions. Courtesy of the U. S. Army Quartermaster Museum, Fort Lee, Virginia.

The major drawback of canned goods during the Civil War was their price. The industry, being immature and inchoate, simply had neither the technology nor production processes for higher production rates of tin cans. As a result, canned goods were most often eaten by officers or wealthy enlisted soldiers who could afford them. They were not democratically distributed because of the price. Canned goods were least expensive when purchased from the Commissary Department to support a hospital or officers mess. When the aforementioned Lieutenant Locke purchased items for the hospital in Jacksonville, Florida, in March 1864, they came from Army supplies. The peaches cost 42 cents per can, while the tomatoes were 50 cents each, and these were

comparatively inexpensive as they avoided the mark-up of the regimental sutler.⁷⁵

Canned goods were most expensive when purchased from a sutler. John Billings noted that when purchased from a sutler, condensed milk cost "seventy-five cents a can; but only a recruit with a big bounty, or an old vet the child of wealthy parents, or a re-enlisted man did much in that way."⁷⁶ Emanuel Blanchard, the surgeon responsible for the Army hospital at Brownsville, Texas, purchased canned goods from a sutler named C. C. Blood and Company on September 8, 1865. He bought two dozen cans of oysters for 75 cents per can, a dozen cans of blackberries at 92 cents each, six cans of condensed milk at 75 cents per can, and two cans of jelly also for 75 cents each.⁷⁷ Brownsville was at the end of a tenuous supply chain, and transportation costs were high. Nevertheless, these prices validate not only the commonly held belief by soldiers that sutlers were war profiteers, but that canned goods were available, yet extremely expensive during the Civil War.

The Confederate States Army (CSA) had some exposure to canned goods, but their use and availability did not come near that of the Union. The seemingly blasé fare of Union regular rations was regarded as nothing short of exceptional by the perpetually hungry Confederate soldier. The regular ration allotment was reduced several times throughout the war. As a result, the Confederate soldier was fed irregularly on a diet consisting of cornbread and beef with few vegetables or fruits. The primary impediment

⁷⁵ H. W. Locke to Jacksonville, Florida Union Army Hospital, March 1864, "Civil War Documents," Fort Lee, Virginia.

⁷⁶ Billings, *Hardtack and Coffee*, 118.

⁷⁷ Emanuel Blanchard to C. C. Blood & Company, Brownsville, Texas, September 8, 1865, "Civil War Documents," Fort Lee, Virginia.

to feeding the CSA armies was distribution. The issue stemmed from a variety of sources: corruption, inefficient administration by the commissary department, little available salt for preserving meat, and transportation difficulties. There was also a general shortage of items for packaging, such as sacks, kegs, barrels, and tin cans. Iron or steel, the base substrate for a tin can, was put to use building rifles, cannon, ordnance, or armor plating, not making tin cans. To supplement their meager rations, the Confederate soldier resorted to many of the same measures as Union soldiers such as foraging, stealing, local purchase, boxes from home, and buying from sutlers. However, owing to the shortages of packing materials and the Union blockade of coastal ports, the boxes from home and Confederate sutlers' wares had very few, if any, tin cans. The most promising avenue for eating canned goods was from captured Union supplies. After Confederate victory at the Battle of Seven Pines, Virginia in June 1862, a soldier from Tennessee, E. D. Patterson, reported on the condition of the battlefield and observed "here were Sutlers' tents filled with luxuries." A few of the items he listed were canned oysters, pineapples, and sardines. Patterson continued "my first business was to eat as just as much as I possibly could, and that was no small amount, for I had been living on hard tack for several days."⁷⁸

The hunger suffered by the Confederate soldier was revealed by Sam Watkins in his memoir of the war entitled "*Co. Aytch: A Confederate Memoir of the Civil War* (1882). Watkins served with the First Tennessee Infantry Regiment, also known as the

⁷⁸ Bell Irvin Wiley, *The Life of Johnny Reb: The Common Soldier of the Confederacy*, 1943 (Baton Rouge: Louisiana State University Press, 2008), 90-107, 76.

"Maury Grays," from 1861 until the final surrender in late April 1865. While retreating from Perryville, Kentucky in the autumn of 1862, his unit killed a calf and were so hungry that, "we ate that beef raw and without salt." He reported that rations were scarce while stationed in Chattanooga in 1863, but when they departed the city the Confederates burned "immense piles of army stores and provisions which had been accumulated there" and "all now to be given to the flames, while for months the Rebel soldiers had been stinted and starved for the want of these same provisions." He blamed corrupt commissary officials and called them "cormorants." Watkins never reported eating food from a tin can, but he was certainly aware of the technology. He was once present at a speech given by Jefferson Davis, President of the Confederate States of America, and his Secretary of State, Robert Toombs, in the winter of 1864-1865. Watkins expressed disillusionment and growing cynicism when he summarized their speech. In Watkins words, the duo told the assembled men they expected to "whip the Yankees" and "they would skedaddle back across the Ohio [River] like a dog with a tin oyster can tied to his tail. Captain Joe P. Lee and I laughed until our sides hurt us."⁷⁹ Too bad Watkins did not have the opportunity to consume the oysters in the allegorical can. The Confederate soldier was aware of canned food, but rather than being prevented from buying them because of the price, supply and a general lack of food of any type was their primary problem.

In 1867 the Commissary General of Subsistence for the U. S. Army, General A. B.

⁷⁹ Sam R. Watkins, *"Co. Aytch:" A Confederate Memoir of the Civil War* (NY: Simon & Schuster, 2003 (1882)), 48, 96, 105, 184.

Eaton, directed that a report be compiled on the use of canned goods during the conflict and their potential future adoption as a reliable regular ration. The officer chosen to compile the report was Captain Thomas Wilson, a professional commissary officer during the war who had served on General George McClellan's staff during the ill-fated 1862 Peninsula Campaign. He was also one of the leading "experts" on canned food in the Army. His instructions from Eaton were to "collect materials and make notes upon the whole subject of canned articles, with a view, ultimately, to your preparing some extended notes on the subject for the general use and advantage of the public service of this department."⁸⁰ Wilson's report, *Notes on Canned Goods*, was fifty-two pages in length and accomplished three purposes. First, it chronicled the experience with canned rations during the Civil War. Second, Wilson prepared an excellent account on the state of the canning industry in the mid-1860s. Finally, and most importantly, his document was an instructional and informational primer for fellow Army officers who had little experience with canned food. In Wilson's words, "I respectfully transmit the above notes, hoping they may be of service to such officers of the Department as the purchase of canned goods may be entrusted."⁸¹

Wilson began his *Notes* with a general description of the state of canning prior to the Civil War and during the course of the conflict. He remarked that canned goods before the War "sold for fabulous prices, and were consumed by only a few." However,

⁸⁰ Thomas Wilson, *Notes on Canned Goods, Prepared Under the Direction of the Commissary General of Subsistence, U. S. Army* (Washington, D.C.: United States War Department, 1870), 1, 52.

⁸¹ *Ibid.*, 52.

at the outbreak of "the Rebellion in 1861" there was a change, and new canning factories "sprung up everywhere," because "the demand for the supply of the army, through sutlers, became enormous." That the buyer for these cans were the aforementioned sutlers confirms that canned goods were not a regular item of soldiers' rations. One concern of Wilson's was that as new canners entered the market, competition caused quality to decline. He specifically remarked that many canners were "putting up an inferior article with fraudulent weights" and that best practice was to purchase only from "those leading and reliable houses." Most of his purchases for canned goods emanated from his post in Baltimore, and he listed seven categories of canned articles which were generally available during the Civil War: fruits and berries, jellies, fish, preserved meats, vegetables, preserves and jams, and shellfish. The variety of canned foods available was substantial, totaling nearly one hundred different items.⁸²

Captain Wilson described the current position of canning in the mid-1860s with his description of Baltimore "perhaps now the largest market in the world for these goods." Wilson mentioned the extreme secretiveness of the industry and recounted an incident where a new packer "paid, at its beginning, no less than \$5,000 for the art." He described how cans were hermetically sealed, the filling and processing of cans, the dominance of the oyster industry in Baltimore, the modes of harvesting oysters and lobsters, how a canning factory was arranged, and the process of making a tin can in the pressroom. The cans were made at this time with some simple mechanical

⁸² Ibid., 3-6.

contrivances, such as squaring shears for can bodies, blanking presses for tops and bottoms, and a horizontal metal post for forming the cylinder and soldering it. He estimated that the rate of tin can production was 500 to 700 cans per day from an "expert workman."⁸³

Wilson's most significant contributions were to educate fellow officers on pertinent information concerning canned food and provide instruction on their future purchase for adoption on frontier military posts. He began with the sizes of cans available on the market and recommended "two-pound cans the only size that should be purchased for the army, whether for officers or soldiers." His reasoning was that the two-pound can was a better value for the money. The largest section of the report, nearly thirty pages, described the growing seasons, cultivation, selection, and preparation of various fruits and berries, vegetables, shellfish, jams, jellies, meats, and other fish for army use. He was prescient in his opinion that oysters, lobsters, peaches, peas, tomatoes, corn, and various jams and jellies were appropriate for army use. These items "possess the best keeping quality, to be the most in demand, and in their preserved condition best retaining their distinctive natural qualities."⁸⁴ These items would remain the most common and popular canned goods throughout the nineteenth century for both military and non-military use. Wilson concluded his report with a section on how to place advertisements for bidders of canned goods, how to process the bids, sample and inspect the products, and watch for possible defects when

⁸³ Ibid., 2, 12.

⁸⁴ Ibid., 6-7, 15.

ordering certain types of products. Wilson's *Notes* provided the novice canned food purchaser with a wealth of knowledge and instruction. It is exceptional in the breadth, range, usefulness, and history of canning before and during the Civil War and immediately thereafter.

The growth and geographic spread of canning resulted from the Civil War. The industry in Baltimore grew substantially during the war because of its canning heritage and the proximity to the Army of the Potomac. According to the *1863-1864 Baltimore City Business Directory*, there were nine firms producing and selling hermetically sealed canned goods and sixteen oyster packers. Four of these firms offered both lines of business; therefore there were twenty one canning plants in Baltimore compared to five a decade earlier.⁸⁵ On the other coast, in California, disconnected by virtue of distance from normal Army supply channels, canning, particularly of fruit, grew by necessity. The firm California Packing delivered 11,000 cases of canned peaches, plums and apricots to Union Army and Navy forces in 1865 alone.⁸⁶ The Civil War was a boon to meat packers such as Swift, Armour, and Libby in Chicago. Vegetable canners, such as Gilbert Van Kamp and Thomas Duckwall, also prospered and opened new facilities in Ohio, Indiana, and Illinois. During the Civil War, canners "were enjoying the first boom of an immature

⁸⁵ Original source as cited in Kee, *Saving Our Harvest*, 17.

⁸⁶ Vicki L. Ruiz, *Cannery Lives: Mexican Women, Unionization, and the California Food Processing Industry, 1930 - 1950* (Albuquerque: University of New Mexico Press, 1987), 22. The introduction to Ruiz's work contains background information on canning during the nineteenth-century in California. The standard size in use during the Civil War was called a "2#" can, and it held close to a quart of product. There were 24 cans per case; therefore, this firm delivered roughly 264,000 cans of fruit.

American industry."⁸⁷

The Census of 1870 was the first to include a specific section on "canning and preserving." This change indicates that the industry had attained a status noteworthy enough to merit inclusion in the Census. In 1870, there were ninety-seven establishments, or canning factories in the United States. These plants employed 5,869 workers, of which 72 percent were women or children under the age of fifteen. Most of the women and "youths" were engaged in the washing and preparation of the fruits or vegetables. The total value of the products canned was \$5,425,677. The leading states for canning, in order of value of packed product, were Maryland, New York, New Jersey, Maine, and Pennsylvania. These five states packed 87 percent of all canned goods in the United States, with Maryland alone accounting for nearly 30 percent of the total. The East Coast was still dominant, while the South was far behind the rest of the country. Only three states of the former Confederacy reported having canning plants -- Virginia, Georgia, and Florida. These states had one plant each and recorded less than one-half of one percent of the total value for all canned goods in America.⁸⁸ The estimated annual output of American canned goods in 1870 was 30 million cans; a six fold increase from the beginning of the decade. The 1860s had been a landmark for the acceptance

⁸⁷ May, *Canning Clan*, 79.

⁸⁸ U. S. Department of the Interior, *The Statistics of the Wealth and Industry of the United States*, Ninth Census, Volume III (Washington, D.C.: Government Printing Office, 1872), 436. There were 742 horsepower of steam engines used in canning in 1870 and New Jersey was the leader with 283hp, followed by Maryland at 190hp and New York with 144hp. The top three canning states used 83% of industry horsepower. The leader in canning, Maryland, lagged in using the most modern technology due to an abundance of inexpensive labor.

of the tin can in America.⁸⁹

After the Civil War, the Army and Navy began to institutionalize the use of canned food and make it part of the regular ration of a soldier or sailor. Post-Civil War, the majority of the rapidly demobilized United States Army was used as either an occupation force during Reconstruction in the South or garrisoned in small forts throughout the western United States. In 1878, the Army made canned food part of the "reserve ration" for use by soldiers separated from cooking facilities. These rations were intended to be consumed by soldiers on mounted patrols emanating from their secluded posts in the West. These lightly equipped patrols improved their speed by not toting field kitchens with them. The "reserve ration" consisted of canned fresh or corned beef and canned baked beans.⁹⁰ No longer did a soldier have to depend upon a sutler, a package from home, spend a stint in a hospital, or eat at an officers' mess to find canned food part of his regular diet. Further evidence of organizational institutionalization of canned food by the armed forces is contained in several 1890s publications. In 1896 the Army published a *Manual for Army Cooks* which included a three page section on how to prepare canned rations, an indication canned food was a regular portion of the rations. It offered sage advice such as "before using canned goods, see that the ends of each can are sunk in. If the ends of the can are springy or

⁸⁹ There are no data on the number of cans produced contained in the 1870 Census. However, 30 million cans is the generally accepted figure used by various authors. See Collins, *The Story of canned Foods*, 15; Kuhlmann, "The Processing of Agricultural Products in the Pre-Railway Age," in *The Growth of the American Economy*, ed. Harold F. Williamson, 203; Boorstin, *The Americans: The Democratic Experience*, 316; Busch, "An Introduction to the Tin Can," 97.

⁹⁰ Erna Risch, *Quartermaster Support of the Army: A History of the Corps, 1775-1939* (Washington, D. C.: Center of Military History, United States Army, 1989), 528.

bulged outwards, look upon it with suspicion. A swelled or bulged can usually means fermented contents and spoiled goods." There were instructions on how to serve canned fruits, vegetables, canned meat, soups, salmon, lobster, and shrimp. According to the *Manual for Army Cooks*, canned fruits were "delicious and refreshing" when served cold. Care needed to be taken with canned vegetables; the brine in the can poured off and contents washed in water before preparation. If the cook followed these instructions, "it will then be difficult to distinguish the difference between the canned and freshly picked."⁹¹

The Army also published in 1896 a *Handbook of Subsistence Stores* as a guide for officers whose responsibilities included purchasing food and canned goods for the Army. The genesis of the *Handbook* was Wilson's *Notes*, but it is nearly four times the length of this initial study. It contained sections on the varieties, growing seasons, grading, and processing of nearly twenty commonly canned items: apples, pineapples, apricots, peaches, pears, corn, tomatoes, beans, beef, various jams, milk, crab, salmon, sardines, soup, and oysters. The manual also included a section on what to observe when conducting inspections of Army contracted packing plants. There was an appendix, "Notes on Canned Goods," which addressed specific quality issues such as soldered holes on tops of cans, reprocessing, quality of the tin, age of the product, and the effects of cold and freezing on canned goods. The conclusion of the *Handbook* was that "age works no harm to canned goods." Tests on the effects of cold and freezing

⁹¹ U. S. War Department, Subsistence Department, *Manual for Army Cooks Prepared Under the Direction of the Commissary General of Subsistence* (Washington, D.C.: GPO, 1896), 196-198.

were conducted by the Army on canned goods in both Minnesota and northern Canada. The products were frozen solid and allowed to thaw over the course of two summer-winter cycles, then opened and retested. The report from the officer in charge of the tests, Brigadier General A. W. Greely, Chief Signal Officer of the Army, stated that the "flavor was as good when the contents of the last can were eaten as in the first month." General Greely must have been very hungry as later tests by the Army determined "a permanent chemical change had taken place [in frozen canned goods]," but that by immersion in cold water "they can be restored to nearly their original condition."⁹² The 1896 *Handbook and Manual for Army Cooks* both demonstrated the increasing reliance by the armed forces on canned goods, and recognition that those who purchased or prepared canned rations required instructions on how to use them.

The Spanish - American War in 1898 was the first American armed conflict in which canned food was distributed as part of the regular field ration. It was the first American war in which herds of cattle did not follow the troops, so canned, salted, or refrigerated beef was quite common. Condensed milk was also provided by Borden's Milk Company and the PET Milk Company. According to Theodore Gamble, a future President of PET, "one of the great stimulants to the Company's sales in the late nineteenth century was the Spanish - American War. Our products were supplied to soldiers, sailors, and marines in the Philippines, in Cuba, and in other tropical battle

⁹² U. S. War Department, Subsistence Department, *Handbook of Subsistence Stores* (Washington, D. C.: GPO, 1896), 192-197.

areas."⁹³ On the voyage from Tampa, Florida to the landing beaches outside Santiago, Cuba, Trooper Arthur F. Cosby of the 1st U. S. Volunteer Cavalry, the Rough Riders, reported that "our food on board ship is the same; coffee, hardtack, with canned beef (that must have been cooked it is so stringy and tasteless), canned tomatoes and beans."⁹⁴ The Chief Commissary of the Shafter Expedition to Cuba, Colonel James F. Weston, believed that previous experiments in serving canned beef to soldiers had been successful and assumed military operations would be relatively brief, so he directed the purchase of canned beef as the principle ration for the Spanish - American War. He intended that the canned beef be mixed with fresh or canned vegetables to make a stew. Over three million pounds of canned corned beef were sent to Tampa in May 1898 and nearly seven million pounds during the entire conflict. Most of this product was packed by Armour Packing and Libby, McNeil, and Libby of Chicago. The prolonged voyage to Cuba in a hot and humid environment, with few precautions taken to store the canned beef once in Cuba, soon spoiled most of the product. Additionally, with few cooking facilities, many soldiers ate the beef cold, without condiments, and there were few vegetables, either canned or fresh, available to make a stew.⁹⁵ Like Trooper Cosby, many soldiers disliked canned beef, found it unpalatable, and became sick when they

⁹³ Theodore R. Gamble, "Seventy Five Years of the PET Milk Company (1885-1960): The Company That Founded an Industry," An Address Given in St. Louis , Missouri to the Newcomen Society in North America on October 13, 1960 (Princeton: Princeton University Press, 1960), 16.

⁹⁴ Frank Friedel, *The Splendid Little War: The Dramatic Story of the Spanish-American War* (Short Hills, N.J.: Burford Books, 2002 (1958)), 58.

⁹⁵ Risch, *Quartermaster Support of the Army*, 528-533; Michael E. Hucles, *From Haversack to Checkout Counter: A Brief History of the Army Commissary System* (Fort Lee, Va.: U. S. Army Troop Support Agency, 1991), 72-74.

consumed it.

Canned food use in the Spanish - American War was certainly controversial. Charges of "embalmed beef" being served to the soldiers were made by the Commanding General of the Army, Major General Nelson A. Miles, who argued that the Subsistence Department experimented with the rations, insinuated the beef was tainted with some type of chemical additive, and implied that the Subsistence Department had been criminally negligent. These accusations led President William McKinley in December 1898 to appoint Grenville Dodge, retired general officer, congressman, and railroad executive, to lead an investigation into Miles' accusations. The Dodge Commission interviewed hundreds of veterans of the conflict, as well as the firms which supplied the canned beef. There were reports from all units sent to Cuba, but the wide range of comments from within units baffled the Commission. For example, Captain R. H. Anderson of Company A, 9th Infantry said the canned beef was "fairly satisfactory," while his neighboring unit, Lieutenant A. W. Brewster of Company B, 9th Infantry said "the meat was of inferior quality, for the most part scraps and odds and ends of beef." Captain George Palmer, commander of Company D, 9th Infantry, remarked there were "no bad results" from consuming the beef. The most incisive comment came from Captain T. S. McCabb of Company F, 9th Infantry, when he explained "the canned roast beef issued for use as part of the ration . . . impressed me . . . as unsuited for campaigning in a warm climate. The effect of heat on the cans made the contents

unpalatable and caused rapid deterioration of the meat after the cans were opened."⁹⁶

The Dodge Commission concluded the allegations of General Miles were unfounded, but made suggestions to improve the handling of rations in tropical environments.

The Army and Navy learned lessons from the experience with canned rations during the Spanish - American War. This was a further step in the institutionalization of canned food as rations for soldiers and sailors. In 1900, the Army updated the 1896 version of the *Handbook of Subsistence Stores*, the training and educational manual for subsistence officers. The first 190 pages are a reprint of the 1896 version, but there are new appendices on specifications for purchasing salted meat, general guidelines on minimum and maximum storage temperatures for various canned products, safety concerns, and transportation requirements. It was recognized that extreme cold or hot temperatures harmed canned products, a marked change from just four years earlier. The new edition noted that "canned tomatoes when frozen become stringy" and suggested refrigerated railroad cars should be used for perishable products in warm environments. Canned products in a warm climate "should be kept in cold storage below 39° F."⁹⁷ Likewise, the Navy learned from the experience of the Spanish - American War. The Navy issued a series of circulars from 1898 to 1909 detailing specifications required for a vendor to supply various canned food items to the Navy. The documents are evidence of the growing use of canned food by the Navy and

⁹⁶ Dodge Commission Report, *Food Furnished by Subsistence Department to Troops in the Field: Record of a Court of Inquiry*, Volume III (Washington, D. C.: GPO, 1900), 2105-2106. The selection of the 9th Infantry was made because the author served with this unit from 1987-1989.

⁹⁷ U. S. War Department, Subsistence Department, *Handbook of Subsistence Stores* (Washington, D. C.: GPO, 1900), 207-219.

institutionalization of canned goods through standardized quality, packing, and shipping requirements. The specifications for tinned corned beef required a vendor supply "best quality corned ox beef." Additionally, the vendor "shall guarantee that the beef shall keep good in any climate for one year from the date of delivery."⁹⁸ The requirement to select the "best quality" product and not process residuals, as well as a one year "guarantee" of edibility, "in any climate," were standard conditions of these specifications regardless of product. These conditions applied to canned corned beef, as well as ham, vegetables, peaches, tomatoes, corn, and string beans. Both the Army and Navy recognized the need to safeguard the canned food supply, whether it was from actions taken on the part of service personnel, or by a vendor through product selection and packing prior to delivery.

By World War I, tin cans were ubiquitous and soldiers soon grew very accustomed to eating food from cans. In that war combat was characterized by limited periods of mobile warfare at the beginning and end of the conflict, but stationary trench warfare persisted for most of the struggle, at least on the Western Front. As standard practice, units had field kitchens located in close proximity to the front line while it was stationary, which provided food, often from large-sized tin cans. The rations in cans were for groups of ten to twelve soldiers and were not individually packaged. During the war, 75 percent of the canned salmon and 40 percent of the canned tomatoes

⁹⁸ U. S. Navy Department, Bureau of Supplies and Accounts, *Specifications for Tinned Corned Beef*, by A. S. Kenny, Paymaster General, U. S. Navy, Washington, D.C., July 1, 1899, CIS Executive Branch Documents, 1789-1909, oclc # 244126796.

served to American and Allied soldiers came from tin cans packed in the United States. There were 500 million cases of food from the United States delivered to the American Expeditionary Force and our Allies throughout the war.⁹⁹ One type of canned ration kept in the front lines, but not in the rear with the kitchens, was another version of the "reserve ration." These rations consisted of "a cardboard box holding gas-proof tins of corned beef and hard bread, with some chocolate, coffee, and sugar."¹⁰⁰ These rations were to only be used in extreme emergencies, such as enemy artillery bombardment when ration parties could not reach the field kitchens. Ultimately then, whether served canned food from a field kitchen or forced to eat "reserve rations" while in a dugout under enemy artillery fire, canned food was no longer a novelty for the soldier by the end of World War I.

The most notable development in tin cans between the World Wars was the individual ration known as the "C-Ration." This was the first occasion of the Army fielding a canned ration for the solitary soldier. The C-Ration was developed in 1938 and used until the 1980s by American armed forces. In its initial form, the C-Ration weighed five pounds, ten ounces, packed 4,500 calories, and was designed to supply the daily ration of three meals for a soldier. It consisted of an accessory package, 2 chocolate bars and six cans of food (see figure 2.4). The accessory packet included cigarettes, gum, water purification tablets, salt, pepper, and toilet paper. Three of the tin cans

⁹⁹ National Canners Association, *The Canning Industry*, 1971, 8; Edward C. Hampe, Jr. and Merle Wittenberg, *The Lifeline of America: Development of the Food Industry* (NY: McGraw-Hill Book Company, 1964), 125.

¹⁰⁰ Barbara Moran, "Dinner Goes to War," *American Heritage of Invention and Technology*, Vol. 14, No. 1 (Summer 1998), 12.

contained a meat and vegetable product, while the other three had crackers, candy, coffee powder, jam, cocoa powder, and sugar. One can of each type constituted a meal and the rations were eaten either hot or cold. There were ten varieties of the meat and vegetable product.¹⁰¹ Later developments provided a single boxed ration of four cans and an accessory packet. Three boxes of this style C-Ration comprised the daily ration for a soldier. Each box had some type of main course meat product, a can with crackers and chocolate bars, a tin of jam, cheese, or peanut butter, and a can of dessert. The dessert was either fruit or a baked cake -- fruit, orange nut, or pound. By World War II, nearly 65 percent of the food consumed by American armed forces came from cans, and service personal were considered "the best-fed in the world."¹⁰²

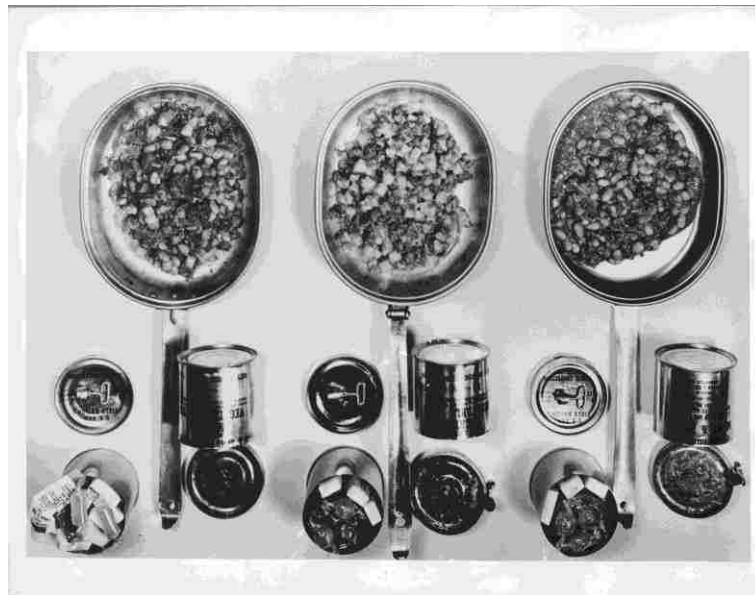

Figure 2.4 - 1930s Era C-Ration. Two tin cans were provided for each meal. Courtesy of the U. S. Army Quartermaster Museum, Fort Lee, Virginia.

¹⁰¹ Moran, "Dinner Goes to War," 14-17; Colonel J. J. Powers, "Rations," *The Quartermaster Review*, Vol. 22, No. 1 (July-August, 1942), 39-40. The components of the post-WWII C-Ration are from personal memory.

¹⁰² NCA, *The Canning Industry*, 1971, 8; CMI, *The History of the Metal Can*, 1960, 20.

During the twentieth century, canned food was a staple component of a soldier's, sailor's, or airman's diet.

The United States Army, and to a lesser degree the Navy, were the forces that popularized and familiarized the American public with the tin can. The period from 1810 until 1860 was characterized by limited demand and ad hoc efforts at organizing the nascent industry. The tin can during this period was extremely expensive and considered a novelty. The turning point for both canning and can-making was the Civil War. During the Civil War, canned food was diffused by the Union Army and introduced to the citizen-soldier through a variety of channels -- sutlers, boxes from home, hospitals, the Commissary Department, an officer's mess, and service on distant posts. The military recognized the utility of canned rations, and after the Civil War, it institutionalized and further expanded use of canned food in the soldiers' diet. Concurrently with the military in the post-Civil War period, American society saw cans as a technology that added variety to their diet, was a durable and convenient food storage technology and a method to save food produced in one season for use in another -- saving the harvest. However, despite the great advantages of canned food, the major drawback was price. Canned foods were still expensive and beyond the means of many Americans during the Civil War. Many key actors recognized great potential and profit in commercializing canned food for non-military use and wider distribution, but they had to reduce the price. The first step was mechanization of the

canning and can manufacturing processes. Technology had a significant impact on reducing prices in the 1870s and for the next fifty years.

Chapter 3 - Technology and the Tin Can

It is well known, that the consumption of canned goods has become well-nigh universal throughout the world, owing to the cheapness with which they can be supplied.

American Machinist, 1883¹

Machines do what scores would have to labor hard to accomplish. In removing this drudgery, they make life more livable.

A. W. and K. W. Bitting, 1916²

The "Golden Age" of growth, from both a technological and social perspective, occurred in the can manufacturing and canning industries in the four decades following the Civil War. It was a period of rapid technological change, yet incomplete market diffusion. The need, in the eyes of the canner and consumer, was lowering the price of canned goods so that they were amenable for mass consumption. Through the development of improved technology for the canning and can-making processes, the quest for lower prices was accomplished by the early twentieth century. One result of the dizzying pace of change was the creation of a separate and specialized industry -- can-making. The process of technological change in can-making was characterized by mechanization in five, somewhat overlapping, phases that addressed specific parts of the production process. The new machines and devices invented in the late nineteenth century were primarily incremental improvements on previous technology, but breakthrough advances were also present. Innovation by independent inventors in the

¹ Unattributed, "Norton's Automatic Can Making Machinery." *American Machinist*, Vol. 6, No. 28 (July 14, 1883), 1.

² A. W. Bitting and K. W. Bitting, *Canning and How to Use Canned Foods*, 9.

nineteenth century gave way to industrial research and development by the early twentieth century. This chapter will explain and describe how mechanization and technological change led to lower can prices, thereby facilitating their commercial distribution; the separation of can-making from canning; and the creation of the can manufacturing industry.

The first can-makers in America were tinsmiths who began making tin cans as part of their line of wares. The first American born tinsmith was Shem Brown of Boston. He was raised in Kittery, Maine, but moved to Boston in the late seventeenth century. Brown offered a line of tin household products, but he did not make tin cans. The first large-scale hand-manufacture of tinware was done by Edward Pattison of Berlin, Connecticut in 1740. The industry became centered in New England in general, and Connecticut in particular, because of the availability of skilled labor. Tinsmiths were highly skilled craftsmen, and by the late eighteenth century, there were accepted apprenticeship practices that followed the English custom, lasting seven years. The apprentice was indentured to a master and first learned to make simple items, such as pastry stamps, then graduated to more complex forms such as basins or pails, and eventually created ware requiring multiple parts. After the seven year apprenticeship, a journeyman tinsmith could make all variety of household items, such as candlesticks, bedpans, foot warmers, bowls, cups, pie tins, utensils, and tin cans. These products were sometimes made-to-order, but most often were sold by an itinerant peddler, who roamed the back roads of America and sold their wares at local markets. Tin salesmen

were important to the expansion of the industry and "were America's first peddlers or door-to-door salesmen and were sometimes called walkers."³ Can-making had its roots in the colonial craft practices of the tinsmith, but tin cans were a minor portion of their product line until the nineteenth-century invention of canning.

The basic raw material for a tin can was initially iron, later steel, dipped in a molten bath of tin. The tin coating forms a protective barrier to inhibit corrosion of the iron or steel, but represents a small proportion of the total material contents for the container. Contemporary tin coatings are 1½ to 2 percent of a container's weight, but were somewhat more in the early nineteenth century. Great Britain, and Wales in particular, "controlled the market [tin plate] from the time of the first commercially produced plate in the eighteenth century until a tariff act was passed by the United States Congress in 1890."⁴ The process for manufacturing tinplate began with heated iron bars being pounded by hand, or by either water-powered or mechanical trip hammers, until they were twice as long and wide as the initial bar. The sheets were then dipped in a mixture of earth and charcoal to cool. After cooling, the sheets were placed on rollers in another furnace in stacks of one hundred sheets. The sheet stacks would be heated and the position of the sheets in a stack changed to insure uniform heating. The stacks were removed and again reduced in thickness through pounding by

³ Beatrice Farnsworth Powers and Olive Floyd, *Early American Decorated Tinware with Designs and Practical Directions* (NY: Hastings House Publishers, 1957), 34-37, 44; Henry J. Kaufman, *Early American Copper, Tin and Brass* (NY: Medill McBride Company, 1950), 26; Margaret Coffin, *The History and Folklore of American Country Tinware, 1700-1900* (Camden, N.J.: Thomas Nelson and Sons, 1968), 24-25.

⁴ Shirley Spalding Devoe, *The Tinsmiths of Connecticut* (Middletown, Conn.: Wesleyan University Press, 1968), 42.

a trip hammer. The process of heat application and hammering was repeated three times. After reduction to the desired thickness, the sheets were cut to size using shears, scrubbed with sandstone to remove surface impurities, then immersed in vats of water and barley to pickle or completely clean the sheets. The next step in the tin plating process was immersion of stacks of twenty to fifty sheets in vats of tin, water, and tallow to coat the sheets with tin. The sheets were allowed to dry, polished with sawdust and oatmeal, and finally packaged. The packages were sold in bundles of sheets measuring 10 x 14 inches to a steel vendor who would then sell them to a tinsmith.⁵ There were several incremental improvements to this process, such as the introduction of grooved rollers instead of hammers in 1783, but the basic process for manufacturing tinplate remained unchanged from 1760 until the 1850s. The demand for tinplate increased in the 1850s shifting from housewares to tin cans. Steam power was introduced to the industry in the 1850s, as well as Bessemer steel. In the 1870s open-hearth steel became the base metal. The transition from iron to steel produced a higher quality product requiring less tin coating.⁶ Continuous tinplating in a bath of ionized molten tin, electrolytic tinplating, was not introduced until the 1930s.

Phase 1 - Craft or Hand-made Manufacture

"Craft or hand-made" can manufacturing was the first phase of technological development in can-making, characterized by extensive use of hand tools. The

⁵ Gould, *Antique Tin and Tole Ware*, 5-8; Coffin, *American Country Tinware*, 13.

⁶ Clark, *The Tin Can Book*, 10.

preeminent maker of early tinsmith tools was Jedediah North and Company of East Berlin, Connecticut. North made tinner's shears, hammers, mallets, chisels, stakes, punches, and soldering implements. He drew orders from nearly all parts of the United States. North was a manufacturer of tools and never made or shipped simple machines for can-making. His business thrived from the 1820s until the 1850s when simple machines began replacing hand tools.⁷ The basic hand tools of a tinsmith for manufacturing tin cans consisted of a divider, compass, scratch awl, shears (lobster, straight, hawk-billed, circular), wooden mallets, stakes, anvils or mandrels, wooden molds, pliers, punches, and soldering irons to include various "coppers." Assuming he would get a repeat order for a tin can, a tinsmith would make a pattern or template of the can. He would use a divider, compass, and scratch awl to make the template for the can on a piece of sturdy tinplate or wood. The templates represented pre-existing shapes and forms to be used by the tinsmith on similar items in the future and served the same function blueprints or mechanical drawings do today. Lobster, straight, and hawk-billed shears were used to cut the large rectangular piece of a can body from a sheet of tinplate, while the circular shears cut the tops and bottoms. Wooden mallets or hand-pressure were used for bending metal. Wood was preferred to metal for bending or hammering as it left few marks on the tinplate. Stakes, anvils or mandrels were devices attached to the tinsmith's bench and were the forms around which the body was bent into a cylinder. The can tops and bottoms were placed in wooden molds

⁷ John H. Demer, *Jedediah North's Tinnery Tool Business* (South Burlington, Vt.: The Early American Industries Association, 1973), iii-vi, 35.

and pressure applied by hand or the wooden hammer to form lips or curls on the outer edges of the tops and bottoms. Pliers were used to handle the tinplate, hold it in position around a stake, or remove it from a mold. Punches made vent holes in the tops of a can. Finally, soldering irons, with various types of tips or "coppers" were used to attach the components together and make a can. Straight coppers were used for uniform flat or even surfaces, such as the side seam, while curved coppers were used for circular surfaces, such as soldering in place the top and bottom.⁸ The hand-crafted can was certainly an item with substantial labor content and hence, low rates of production. Hand tools were the predominant feature of early can-making, and mechanical innovations were limited until the late 1840s and early 1850s.

There was a generally accepted process for assembling a hand-made tin can, but it varied somewhat according to individual taste and technique. There was nothing resembling sequential manufacturing, as would later dominate the can-making industry, and all phases of the production process were done by the tinsmith, sometimes with the aid of a helper. There was no specialization or division of labor in early tin can production. Most tinsmiths would cut the tops, bottoms and bodies of their cans before assembling them. The top was a circular piece of metal with a 1 to 1½ inch opening in the center for filling. The bottom was also circular and the same diameter as the top. The body was a rectangular piece of metal. The first step in assembly was to prepare

⁸ Earl P. Fowler, *Can Crafts* (Radnor, Pa.: Chilton Book Company, 1977), 1-2; Paul N. Hasluck, ed., *Tinplate Work: With Numerous Engravings and Diagrams* (Philadelphia: David McKay Publishers, 1908), 9, 14-21; John H. Demer, "How Tinsmiths Used Their Tools," *The Chronicle of the Early American Industries Association*, Vol. 26, No. 4 (December 1973), 50-52.

the solder. The recipe for solder varied in the hand-made phase of can-making before specialized companies supplied ready-made solder. In 1859, Leroy Blinn, a nineteenth-century tinsmith, stated the preferred mixture was "equal parts of tin and lead, or 2 parts of pewter and 1 part of lead" when attaching two pieces of tinplate together.⁹ Nearly fifty years later, Paul Hasluck, a twentieth-century tinsmith, described making what he called 'tinman's solder' which consisted of one part lead for every two parts of tin.¹⁰ Regardless of the type of recipe used for solder, the application and amount consumed was substantial in the early days of can manufacturing. W. Lyman Underwood, an early twentieth-century industry observer and professor at MIT, described the soldering process: "the tops and bottoms, like the seams, were soldered on with a heavy beading of metal, and enough solder was used on one can to make a dozen of today's [1914] manufacture."¹¹ It is not surprising that solder was generously applied given there were no mechanical controls in the process.

The one point where most tinsmiths followed the same process was in the assembly of the can cylinder or body. The first component to be soldered together was the side seam, or the portion of the can where the edges of the metal met. The body blank was bent, using a hammer or hands, around a stake on the tinsmith's bench. After shaping the cylinder, the edges were overlapped and clamped together to hold them, creating a "lap seam," and were then spot soldered in place, thereby keeping the

⁹ Leroy J. Blinn, *A Practical Companion for the Tin, Sheet-Iron, and Copper Smith* (Detroit: Barns, French, and Way Publishers, 1859), 42.

¹⁰ Hasluck, *Tinplate Work*, 21.

¹¹ W. Lyman Underwood, "The Canning Industry of New England," in Judge, *A History of the Canning Industry*, 13.

cylindrical form. The side seam was completed by removing the clamp and completely soldering the remainder of the side seam.¹² The next step was to solder the ends in place. Tinsmiths would place the can on a hard, flat surface of their work bench, such as a stone or piece of wood. Their technique for attaching the ends varied depending upon the type of seam. One method, referred to as a "flush seam," was to solder the juncture between the top and body on the inside of the can by dropping bits of solder into the can. Tinsmiths who used a flush seam would cut their ends the same diameter as the final desired circumference of the can. The soldering iron would be inserted inside the can and seam constructed using a curved copper. The can was then rotated by hand to get the solder to flow. The can would then be turned over and the process repeated for the bottom. To attach the bottom to a flush seamed tin can, the soldering iron was inserted through the filling hole and bottom then attached. Top first then the bottom was the preferred order for a flush seam.¹³ Soldering inside the can using a flush seam resulted in deposits of solder throughout the interior of the container and was a rather intricate process. Therefore, some tinsmiths preferred to cut the end slightly larger than the diameter of the can, create a lip or flange on the end using a wooden mold, solder the top to the outside of the can body using a lap seam, then repeat the process

¹² James T. Rock, "Cans in the Countryside," *Historical Archeology*, Volume 18, Number 2 (1984), 99; M. L. Dodge, "The Mechanical Features of Salmon Canning," *Mechanical Engineering*, Vol. 47, No. 8 (August 1925), 612; May, *The Canning Clan*, 11-12.

¹³ Techniques for soldering ends to cans during the "craft or hand-made" phase of technological development varied substantially, but eventually settled on lap seams and soldering on the outside of the can body and end juncture. Rock, "Cans in the Countryside," 99, described a process for flush seams on both ends; Dodge, "The Mechanical Features of Salmon Canning," 612, explained a unique process for the salmon industry where the bottom was soldered on the inside using a flush seam, salmon placed in the can, and top outside soldered using a lap seam. Busch, "An Introduction to the Tin Can," 96, explained the process of outside soldering the ends to the cans, which became the industry norm.

for the bottom. Outside soldering of the ends became the preferred method by the mid-nineteenth century, with the top attached first, then the bottom.¹⁴ After the solder cooled, the tinsmith had a finished tin can, but only after much laborious and tedious labor.

The extensive use of hand tools and lack of specialization in a highly variegated production process limited tinsmith's ability to manufacture large quantities of cans. Some tinsmiths employed division of labor to improve production rates. One tinsmith would cut and bend the body cylinder and spot solder it in place. He would pass the can to a companion who would then finish soldering the seam. This person would also place the top on the can and solder it on the inside. The can was then handed to a third person, often a young apprentice, who would place the bottom on the can and solder it to the body by inserting a curved copper through the opening in the top.¹⁵ Most cans were made in the off-season by canners or locally contracted tinsmiths. An average tinsmith could make five or six cans per hour or sixty per day when working a ten-hour day. One industry observer noted that "a tinkerer who could turn out sixty cans a day was a master workman."¹⁶ Additionally, these cans were not always of the best quality and "60 crude cans per day per tinsmith" should be considered the maximum rate of

¹⁴ W. H. H. Stevenson, "Cans and Can-Making Machinery," in Judge, *A History of the Canning Industry*, 92; Collins, 31-32.

¹⁵ D. J. MacNaughtan. *Tin Plate and Tin Cans in the United States*, Published by The International Tin Research and Development Council, Bulletin #4 (October 1936), (London: Lund, Humphries and Company), 84.

¹⁶ W. Lyman Underwood, "The Canning Industry of New England," in Judge, *A History of the Canning Industry*, 13.

production.¹⁷

Given the extensive use of imported tinsplate, the high labor content of the product, the overly generous application of solder, and low levels of production, craft-made tin cans were very expensive. Craft-manufactured tin cans used 25 pounds of solder for every one thousand cans.¹⁸ The 1850 price list from Samuel Harrison Bingman, a Union County, Pennsylvania tinsmith residing in Laurelton, substantiates the pricy nature of craft-made cans. He manufactured a wide variety of tinware, as would most tinsmiths of the times, tin cans comprising a fraction of his business. Bingman's cans were all manufactured using hand tools, before the introduction of machinery on the can-making process. Lard cans and fluid cans were twenty-five cents each, while a can for molasses, probably slightly larger than most containers, was fifty cents. A fruit can listed for twenty-five cents, while other types of tin cans for other than fruit products ranged from twenty-five to twenty-nine cents.¹⁹ The high cost of containers made canned foods uneconomical for the majority of the population. There were not many Americans who could partake of Appert's or Kensett's innovative technology.

Nineteenth-Century Types of Tin Cans

The predominant style of tin can in the nineteenth century was known as the "hole-in-cap" can (see figure 3.1). Also known as the "cap-hole" can, this style would

¹⁷ Rock, "Cans in the Countryside," 99. The figure of sixty cans per day as the production rate for tinsmiths using hand tools is cited often in the literature. See, in addition to Rock, May, *The Canning Clan*, 11-12; Clark, *The Tin Can Book*, 18; and CMI, *The History of the Metal Can*, 1960, 5.

¹⁸ May, *The Canning Clan*, 28.

¹⁹ Lasansky, *To Cut, Piece, and Solder*, 30.

dominate the industry until the early twentieth century when the "sanitary" or "open top" can became the industry standard. An earlier version, the "hole-and-cap" can was comprised of four components: bottom, body, top, and cap. The top, as previously discussed, had a 1 to 1½ in opening cut in the center of the circular piece of tinplate. The food to be canned was thrust through this opening, the can opening was sealed with a cap, and the entire container then processed. The cap, slightly larger than the opening in the top, was soldered in place by an employee known as a "capper." There was no vent hole in the cap for the release of steam pressure generated during capping, so the "hole-and-cap" can often burst or the contents swelled to give the can anything but an eye-catching appearance. The "hole-in-cap" can was similar in construction to the "hole-and-cap" can, but the cap had a small hole pierced in the center to act as a pressure release mechanism for the can. A "capper" would solder the cap over the opening, as before, thereby sealing the can. The small hole in the center of the cap allowed excess heat to vent or exhaust during soldering the cap in place. Once the heat had dissipated and the can cooled, the tin can was sealed by a "tipper." He applied a dab of solder to the vent hole in the center of the cap.²⁰ The "hole-in-cap" can was used as the primary technology to can fruits and vegetables, as well as some meat and seafood products. The type can used for condensed milk was a hybrid of both these cans and consisted of only three components: top, bottom, and body. It was similar to a

²⁰ Rock, "Cans in the Countryside," 99-102; Busch, "An Introduction to the Tin Can," 96. Rock made a distinction between the "hole-and-cap" and "hole-in-cap" cans, while Busch does not. There was a subtle, yet important difference, but the life of the "hole-and-cap" was so short it is often ignored by researchers. Care must be taken when reviewing literature as the terms "hole-and-cap" and "hole-in-cap" are often used interchangeably to describe a can in which there is a vent hole in the cap.

fruit or vegetable can, but rather than having an opening of 1 to 1½ inches and the requisite cap, it had a solid top with a small vent hole and often referred to as a "hole-in-top" or "venthole" can. Milk was filled in a two-piece can (body with bottom attached), the top soldered in place, the can cooked, then the vent hole tipped after evacuating the steam from processing. This type can is still used by many contemporary evaporated milk producers today.

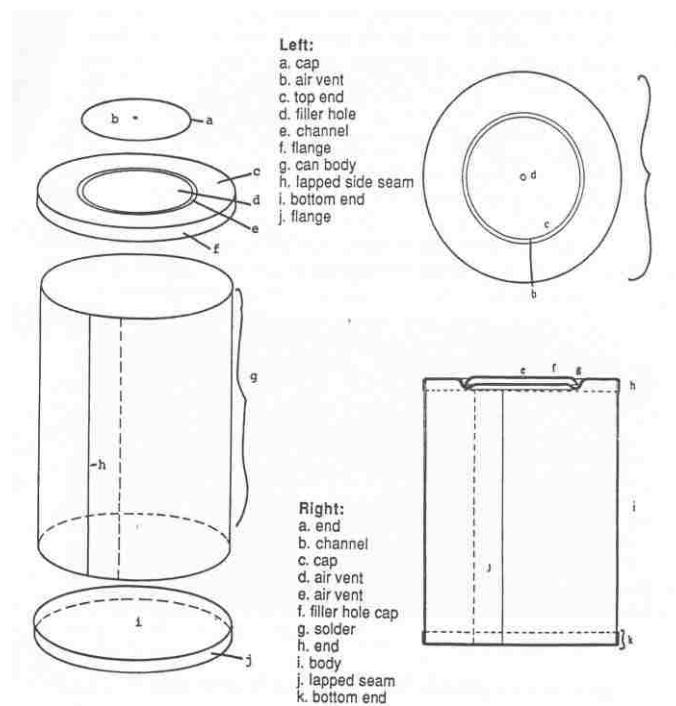

Figure 3.1 - Drawing of Hole-in-Cap Can. Adapted from Edward F. Heite, *Archaeological Data Recovery on the Collins, Geddes Cannery Site*, 14.

Specialty cans for certain seafood and meat products were a mid-nineteenth-century innovation. The "key-wind" can was developed in the 1860s for small seafood products, such as sardines, because current can styles were too large for the small product. The top or side of the can was scored during the manufacturing process

around the circumference of the top or side. There was a tab soldered to the top or side of the can and a small key attached to the can. To open the can, the consumer inserted the key into the soldered tab on the top or side and rolled back nearly the entire top.²¹ There were many variations of this can, but it is properly considered a specialty can distinct from a standard fruit or vegetable container.

The tapered can was developed in the 1870s by two Chicago meatpacking firms: Libby, McNeil, and Libby (LML) and the Wilson Packing Company (WPC). LML packed corned beef in standard #2 cans that cost ten cents each for the just can, but the appeal of the product was limited because customers had to use a fork to remove the contents. The owners of WPC, John and William Wilson, recognized that sales of corned beef could increase if the product slid from the can. LML purchased an 1864 patent from William C. Marshall for \$75 for his process of compressing corned beef by squeezing out the excess water and air, thereby creating a solid pack of meat.²² Meanwhile, the Wilsons had developed a patent for a tapered can (see figure 3.2). The idea was to use a plunger to compress corned beef into the larger end of a slightly rectangular can with rounded corners. The large end would be hermetically sealed and when opened, a squeeze on the smaller end would allow the meat to slide out in a compressed block ready for slicing and serving. The patent for the tapered can was awarded by the U. S. Patent office to John A. Wilson on April 6, 1875. Wilson claimed his invention related to "hermetically sealed cans used in packing meats or other articles; and it consists in a

²¹ Rock, "Cans in the Countryside," 100-101.

²² May, *The Canning Clan*, 212-218.

pyramidal-shaped can, having rounded corners with both ends slightly flaring to form shoulders." The meat was inserted "by means of a plunger through an aperture in the larger head B." He explained further that to remove the contents "the can is to be opened at the larger end" and "when the can is reversed again and a slight tap on the smaller head C will cause the solidly packed meat to slide out in one piece." Wilson claimed as "new" the shape of the can, "pyramidal form with rounded corners" and a "perforated plate" which allowed gases to escape while the meat was packed in the can.²³ The two companies, LML and WPC, combined their patents and almost immediately their process for meat insertion using the tapered can came to dominate the canned meat market.

The cap-hole can may have dominated the can-making and canning industry until the early twentieth century, but there were also other types of food cans targeted at the home-canner or small scale operation. One such can was developed in 1856 by Arthur, Burnham and Company of Philadelphia marketed under the name "Arthur's Air-Tight Self-Sealing Can." According to the firm's advertisement, "these cans and jars are constructed with a channel around the mouth, near the top, into which the cover fits

²³ John A. Wilson. 1875. Improvement in Sheet-Metal Cans. U. S. Patent 161,848, filed March 22, 1875 and issued April 6, 1875.

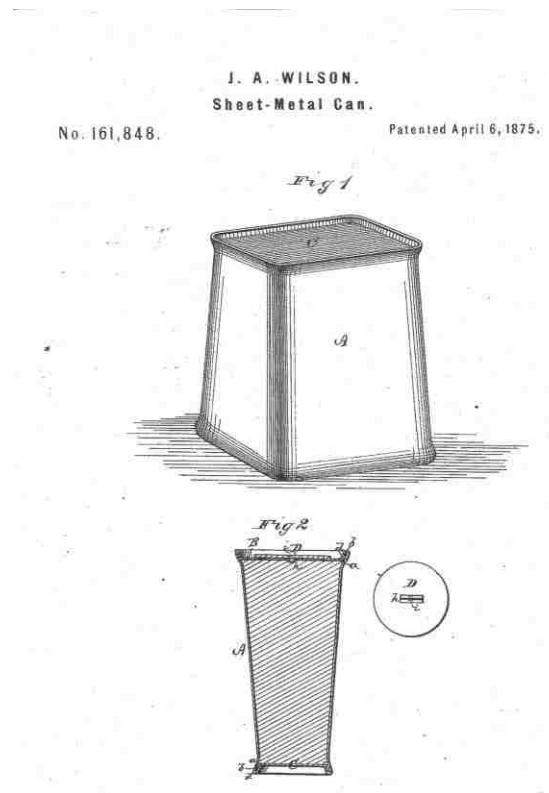

Figure 3.2 - Wilson's Tapered can. Taken from U. S. Patent 161,848, April 6, 1875.

loosely. The channel is filled with a very adhesive cement, prepared for the purpose, and allowed to harden. In order to seal the vessel hermetically, *it is only necessary to heat the cover slightly, and press it into place.*" The company claimed the invention of their can made it easier for individuals or small operations to pack their own produce - "by this simple contrivance, the process of hermetical sealing is placed conveniently within the reach of every individual." The alleged benefits of their can over the hole-in-cap can were secure sealing by anyone "without the aid of a tinner," ease of opening "without the slightest injury to the can," effortless cleaning, the longevity of the can because it was reusable, and they were ready for immediate use as "the cans and jars

are all prepared for sealing." Because of all the advantages of Arthur's Can, even though hole-in-cap cans "may be a trifle lower in price," the company declared it to be a superior product. The prices were seventeen cents for a pint can, twenty-one cents for a quart, and twenty-nine cents for a half-gallon.²⁴ These prices, then, were slightly above market for the mid-1850s.

The home-canner was offered several options of tin cans. In a trade catalogue entitled "Price List of Tin Ware" from William Vogel and Brothers of Brooklyn, published in 1880, there was a "Cover Can" that was "provided with a cover, which being replaced after the top of the can (which is thin tin) has been cut out, will enable the consumer to preserve the contents." The catalogue also contained a "Strip Can" with a removable tin strip holding the can and cover together. The catalogue explained that "removing the strip from this can leaves the cover loose, ready for further use of for protecting contents from dust, &c." Finally, Vogel and Brothers also sold a "Thin Top Can" specifically designed for home canning of condensed milk. The advantage of this can was the "top of this can is made of very light tin, and is easily cut out with a pen knife."²⁵ Arthur's Can and the three styles of tin cans sold by the Vogels offered the advantages of simplified processing, convenience, and reusability to the small-scale or home-canner. Due to their relative complexity and high price, none of these varieties of tin cans supplanted the hole-in-cap can during the nineteenth century. The hole-in-cap

²⁴ Arthur, Burnham and Company, *Arthur's Patent Air-Tight, Self-Sealing Cans and Jars for Preserving Fruits and Vegetables* (Philadelphia: Arthur, Burnham & Company, 1856), 1-2.

²⁵ William Vogel and Brothers, *Catalogue of Tin Ware Manufactured by William Vogel & Brothers* (Brooklyn: William Vogel and Brothers, 1880), 3.

remained the mainstay of the canning industry until the early twentieth-century invention of the sanitary or open top can.

Tin cans were manufactured in a variety of sizes and sold by the dozen or in case lots by a canner to a retailer. The size of the can was dictated by customer preference for a particular food item, as consumers would often purchase only a can or two of a given product. One great advantage of the tin can was that consumers no longer had to purchase items in bulk. Tin cans generally had two names: an industry name and a dimension name. The industry name was a numeric designation such as #1, #2, #2½, etc... Nominally these numbers were supposed to indicate the net weight, in pounds, of product in the container, but in reality they did not. The dimension name, eventually the industry-wide standard size designation, was a combination of two, three-digit numbers. The first number indicated the diameter in inches and sixteenths of an inch, while the second number was the height of the can, from seam to seam, again in both inches and sixteenths of an inch. The increased sophistication of the size designation indicated a desire for industry standardization and the need for accurate measurement for the technologies used in making a can. The most common can in the nineteenth century was the #2 can. This size contained a net weight of approximately 20 ounces of product. Table 3.1 contains specifications for the most common can sizes, the quantity per case or crate, and their most common usage.

Table 3.1 - Common Can Sizes and Case Packs

Industry Name	Dimension Name	Capacity (appx. net weight of food in ounces)	Quantity per Case	Use
#1	211x400	10.5	48	Soups, some fruits, vegetables, meat, seafood
#2	307x409	20	24	Most common for fruits and vegetables
#2½	401x411	29	24	Fruits, some vegetables
#3	404x414	34	24	Fruits, tomatoes
#10	603x700	106	6	Bulk fruits, vegetables

Source: Data from American Can Company, *The Canned Food Reference Manual* (New York: American Can Company, 1939), 116-117, 182.

The Operation of a Canning Line

Commercial tin cans were filled on a canning line, and every line processed fruits and vegetables in the same general sequence. Once the product was received from a farmer or wholesaler, washing was the first step. The food was subjected to rapid flowing streams of potable water along a belt or table to remove any organic debris from the product remaining from the harvest. Cleansing was considered important to maintain strict sanitary conditions in the packing plants. The next step was sorting or grading the product according to size or quality. In some cases food products were passed through screens to separate different sizes, but often this process was performed by manual labor. Depending upon the processor, some may have cleansed first, then sorted, while others may have sorted then cleansed. In either case, cleansing and sorting were the first two steps. After being washed and graded, many fruits and vegetables were blanched. In this process, foods were immersed in warm or hot water

to soften them for further processing, to inhibit further decomposition of the product, or to maintain the desired color of the fruit or vegetable. The next step for some products, such as peas, apples, corn, peaches, and pears, was to peel and core them. Before mechanization of the canning line, this step employed legions of unskilled labor. As the industry progressed throughout the nineteenth century, many of these manual tasks were increasingly performed by machines. The large volume of water used in the early production stages often required canneries to be situated close to a fresh water source, preferably a stream or river, but sometimes a lake.

Early and mid-nineteenth-century canneries packed the product, once blanched, into the hole-in-cap cans. Foods were manually forced through the opening and water, brine, or syrup ladled into the can. The cans were then sealed by capping, and finally tipped and processed. Processing was the most important and secretive aspect of nineteenth-century canning. The sealed cans were processed by immersion in a bath of boiling water. Early canning was not an exact science and canners closely guarded the dwell time, the amount of time a particular product spent in the hot water bath. Too little time resulted in undercooked products subject to deterioration, while overcooking rendered the product mushy, rather inedible, and certainly unappealing in appearance. When the cans emerged from the hot water bath, they were cooled for a short period of time before labeling and boxing the products. The products may have had the canner's specific label, or a label provided by the buyer. Labels were most often printed on paper and glued around the circumference of the can. Occasionally, cans were painted with

decorative designs, but metal decorating was generally a twentieth-century phenomena. After labeling, the cans were loaded into crates and boxes for shipment. Shipping crates in the nineteenth century were uniformly made of wood.²⁶

Labor for a canning line was recruited locally and was highly seasonal in nature. Some employees held other jobs with work in a cannery providing supplemental income, but many worked just during the packing season. The packing season was dependent upon the type of product being canned, and could last from late spring through fall for many products such as corn, tomatoes, peaches, pears, and beans. Canneries packing products such as baked beans, soup, meat, and preserves had a canning season lasting throughout nearly the entire year. In these cases, the labor force was still local, but recruited on a more permanent basis.²⁷ The largest number of workers in nineteenth-century canning lines were employed in the early stages of the process -- sorting, grading, peeling and coring, and filling. Not surprisingly there were a plethora of mechanical devices and machines invented to reduce the labor at the front-end of the packing process. For example, pineapples were washed and sorted, similar to most other vegetables and fruit, then hand-trimmed before slicing and packing. The hand-trimming operation employed long tables of workers whose tasks were to cut off the top and bottom of the fruit, then slice away the outside peel, thereby revealing a

²⁶ Bitting, A. W. and K. G. Bitting, *Canning and How to Use Canned Foods*, 19-42; American Can Company, *Canned Food Manual*, Prepared for The United States Army with the Help and Advice of the Subsistence Branch, Office of the Quartermaster General (New York: American Can Company, 1942), 12-16.

²⁷ National Cannery Association, *The Canning Industry: Its History, Importance, Organization, Methods, and the Public Service Value of Its Products* (Washington, D. C.: National Cannery Association, 1952), 11-12.

solid, cylindrical chunk of fruit ready for slicing and packing. The Ginaca machine, developed in 1914 by Henry Ginaca, a Honolulu design engineer with no previous canning experience, performed all the operations of hand-trimmers in one mechanical operation. A pineapple was fed into the machine and cutters then automatically gauged and positioned themselves for the particular size of the fruit. The machine cut out a cylinder size of fruit, chopped off the top, then the bottom, and finally cored the pineapple. The processed fruit then had to be sliced, also done automatically by another machine, and finally packaged. The Ginaca machine reduced the number of workers employed on a pineapple processing line and made it a safer operation by avoiding injuries sustained by the hand-trimmers through the use of their knives. According to Dr. Averil Bitting, a renowned observer and writer on the canning industry, the Ginaca machine "is one of the ten outstanding inventions in the canning industry."²⁸

New technology also increased throughput of the canning line via reducing processing or cooking times. An autoclave or retort was developed by Andrew K. Shriver, a Baltimore canner, in 1874 replacing the hot water bath (see figure 3.3). Shriver's Kettle used steam pressure in a sealed vessel to cook the product, thereby dramatically reducing processing times and increasing line throughput. Shriver described contemporary practice in his day: "heretofore the can, after being filled, has been boiled in ordinary water, or placed in a bath of salt-water, in which a temperature of 230° is attainable, or in a chloride of calcium, whereby about 245° may be secured."

²⁸ A. W. Bitting, *Appertizing or The Art of Canning; Its History and Development* (San Francisco: The Trade Pressroom, 1937), 315-319.

He stated that canners desired to "allow the tin can to remain as short a time as possible under the action of heat," and this was possible using "salt-water and chloride of calcium to a considerable extent; but these agents are themselves prejudicial to the metal of the can and kettle, causing it to rust and wear rapidly." He believed that "use of the maximum of heat secured by the chloride process, the cans often burst" and "destroy the can" while being "very dangerous to the operator." Shriver used a metal vessel or kettle with steam pipes attached through the bottom of the kettle, and a cover with a pressure relief valve. Cans were lowered into the chamber in baskets, the cover closed, and heat applied using steam pressure. Shriver also included a thermometer and pressure gauge to regulate and control the process. He was aware that the idea of "subjecting the sealed cans and their contents to steam heat above 212° Fahrenheit is not new," but his kettle apparatus and process control mechanisms were unique. Andrew K. Shriver was awarded U. S. Patent 149,256 on February 17, 1874.²⁹

²⁹ Andrew K. Shriver. 1874. Improvement in Apparatus for Preserving Oysters and Other Articles in Sealed Cans. U. S. Patent 149,256, filed February 17, 1874 and issued March 31, 1874.

A. K. SHRIVER.
 Apparatus for Preserving Oysters and other
 Articles in Sealed Cans.
 No. 149,256. Patented March 31, 1874.

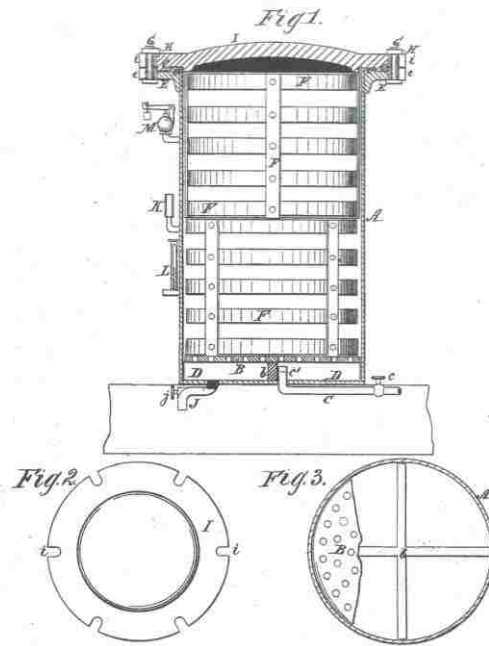

Figure 3.3 - Andrew Shriver's Kettle. Taken from U. S. Patent 149,256, March 31, 1874.

As he acknowledged, Shriver was not the first inventor who conceived of using steam pressure in a sealed vessel to increase cooking temperatures, but he was the first to definitively use it on a canning line. The “Father of Canning” Nicolas Appert used an autoclave for extracting gelatin from animal bones, but not for processing his bottles filled with food. Appert relied upon the work of seventeenth-century scientist Denys Papin and his "digester" in designing his autoclave. Another French disciple of Nicolas Appert, but no familial relation, Raymond Chevallier-Appert, designed an autoclave in

1852 specifically for food conservation, but there is no evidence he used it for this purpose. French canning literature subsequent to Chevallier-Appert's invention makes no mention of his autoclave for use in food preservation. There were two other American patents predating Shriver for an autoclave or retort. Samuel S. Fitch was awarded U. S. Patent 51,164 on November 28, 1865 for a device containing cans and water in a sealed vessel. The heat was applied to this contraption through a fire at the base, either boiling the cans inside or cooking them with steam. There is no record this invention was ever used by a canner, and Shriver's method of injecting steam through pipes and process controls were not anticipated. Lewis McLellan was awarded U. S. Patent 89,419 on April 27, 1869 for an improved culinary boiler. It was designed for cooking corn and "other articles" by boiling the cans of corn or subjecting them to steam, but the interior capacity of his vessel was so limited, little if any use was ever made of his invention. Only Andrew K. Shriver had invented a unique autoclave that became commercially practicable and the prototype for future vertical retorts. He is rightly credited by food historians as the designer of one of the most, if not the most important, breakthrough innovation in canning since Appert's discovery of the process in the early nineteenth century.³⁰ His retort gained immediate acceptance among canners, particularly around his home city of Baltimore.

The most amenable areas for technological innovation on a canning line were reduction of labor in the front end of the process and increasing the throughput of the

³⁰ Samuel A. Goldblith, "Controversy Over the Autoclave: Who First Used the Autoclave for the Preservation of Food?" *Food Technology*, Vol. 26, No. 12 (December 1972): 62-65.

entire line. Efforts of inventors from 1840 through the 1870s were directed at these two areas. Developments post-1880 tended to be improved versions of machines used in peeling, washing, and processing fruits and vegetables and larger capacity, more reliable, and easier to control steam retorts or autoclaves. These two technologies, mechanical processing devices and pressure cookers, both reduced production costs by employing less labor throughout the packing line and producing more filled cans in a given unit of time. Reduced processing costs meant lower prices for consumers. This additional production capacity increased demand and broadened the market for canned goods.

The Process of Innovation in Can Manufacturing

Innovation in can-making and canning was characterized by both incremental and breakthrough innovation.³¹ Incremental innovations solved nagging problems of product design or the production process. They were typically highly directed and focused, most often at one station of the process or aspect of the product design. Often, incremental innovations were improvements made on existing designs that increased speed, expedited throughput, provided for more robust quality, reduced the labor content of the production process, or decreased material costs. Incremental improvements were the most common type of product and process innovation.

³¹ The terminology of *incremental* innovation and *breakthrough* invention used throughout this project was taken from lectures attended by the author and given by the late Dr. Donald N. Frey of Northwestern University in 1990-1992. Dr. Frey was the lead engineer on the Ford Mustang project of the early 1960s, the Chairman and Chief Executive Officer of Bell & Howell Corporation, a lifelong student of invention and technological creativity, and a dear friend.

Breakthrough innovation introduced new production processes or product designs, which solved broad-based problems or addressed current design limitations, and set a new direction for the industry. Industry participants often faced the stark choice of either adapting the new technology for continued participation in the industry, or ceasing operations. By their nature, breakthrough innovations superseded old products and processes and were more costly to adopt due to costs for new equipment. Breakthrough innovations were less common than incremental improvements.

The innovators in can-making and canning were both independent inventors and the industrial research departments of major companies. Individual inventors were often a singular person or in some cases two partners who were driven to invent a new device, process, or product. The most common rationales for innovation were natural inquisitiveness about the industry, the desire to solve a problem, make an improvement, increase efficiency, and of course earn a profit. The locus of creation for independent inventors was often their home or a work shop. Their process of invention was characterized by the desire to solve a problem, primarily through trial and error or empirical approaches. Independent inventors were often cash strapped and almost exclusively self-supporting.³² The contributions of independent inventors were most critical to the canning and can-making industries in the nineteenth century.

Innovations emanating from corporate industrial research were products of

³² Thomas P. Hughes, *American Genesis: A Century of Invention and Technological Enthusiasm, 1870-1970* (Chicago: University of Chicago Press, 2004), 14-24. Hughes categorized invention in two general forms: *radical* or systems-originating innovations and *conservative* or systems-improving inventions (53).

industry consolidation that occurred in the early twentieth century. The inventors, except on patents which required a name, were commonly a team or group of employees. The inventions were seldom solely the product of an individual. Motivations for corporate innovators could be similar to those for independent inventors, but innovation and invention were the occupation for which they were paid a salary. The place of innovation was the company research and development department or laboratory, and it was often well-funded by corporate headquarters. The process of innovation was characterized by the use of science and engineering to bring order to the serendipitous process of creation by systematizing the process of invention.³³ Corporate research and development efforts had more influence upon can-making in the twentieth century than in the nineteenth century.

Independent inventors and corporate industrial research differed on four key points. First, was the scale of their efforts. The work, point of view, and perspective of independent inventors was often very defined, focused, and much more limited than that of an industrial research laboratory. Independent inventors had a few ongoing projects, while corporations often had multiple paths of innovation. This does not imply, however, that the products of independent inventors were less significant than those of the corporate laboratory. Second, as the names signify, the number of persons involved in the invention process was different. Many more employees participated in corporate industrial research projects than those of independent inventors. Third, the

³³ Hughes, *American Genesis*, 138-139.

process of invention diverged significantly. Independent inventors often had experience, but lacked formal scientific or engineering training. As a result, their invention process was empirical and based upon trial-and-error. Conversely, corporate industrial research used science and engineering to systematize the process of innovation. Finally, sponsorship of projects differed dramatically. Independent inventors often lacked the financial resources for their inventions. Development was on a limited and shoestring budget. Even if they developed a potentially successful invention, they often had to seek patrons to commercialize their innovation. On the other hand, industrial researchers were backed by the support of the company. They may have had to squabble internally for funding, but their position was much more secure and enviable than that of the independent inventor.³⁴

There were five, somewhat overlapping, phases of technological development in can-making during the nineteenth and early twentieth centuries. The need to increase throughput was the driving force behind technological innovation, but each phase had a distinct focus on a portion of the process or product. The first phase, "craft or hand-made" has already been discussed. It lasted from when canning was invented in 1810 until roughly the 1850s. The second phase was "proto-mechanization," which began in the 1840s and lasted until the late 1860s. This phase could also be named "metal cutting and bench tools." The developments in the phase concentrated on two distinct issues: expedited cutting of metal and quicker methods to solder side seams. Simple

³⁴ Ibid., 47-52, 180-183.

punch presses, slitters for the bodies, and somewhat more complex bench tools were the innovations in this phase. The third phase was "semi-automatic mechanization" during which nearly every aspect of can manufacturing was transformed. Special attention in can-making was given to shearing tin plate, soldering side seams, and quicker soldering and attachment of tops and bottoms to cans. Soldering operations were mechanized especially capping and tipping the can. This phase began in the 1870s and continued through the end of the nineteenth century. The fourth phase, "integration," began in the 1880s. The focus of "integration" was to link machines in a system of manufacture rather than optimize the operation of a single step in the can-making process. The can-making assembly line was the result. Also occurring during the "integration" phase was the beginning of the design and deployment of automatic machines to support integration and the final phase of technological development, "product design." The sweeping changes in "product design" began in the late 1890s and continued until the 1920s. The result was a fundamental change in the form of the tin can, leading to the basic design still in use today. Radical changes to the tin can required different machines for many production operations, but specifically it changed how tops and bottoms were attached to cans. These product changes required extensive changes in the machines employed; therefore, a new series of automatic machines resulted.

Technological change in can-making was mostly an incremental process, with a focus on specific aspects or problems of manufacture, encountered over time. While

there is a rough chronology associated with this transformation, it is best thought of as a thematic process of change over time. Adaptation of particular technologies depended upon individual business factors for can-makers, such as manual labor availability, location, capital cost of the technology, size of the operation, seasonality, and labor-management relations. As a result, the phases tended to overlap and a leading-edge can-maker would make full use of all available technologies, while late-adopters might still be using a significant number of devices from a prior phase.

Phase 2 - Proto-Mechanization

The "proto-mechanization" phase began in the early 1840s with foot-operated machines mechanizing metal cutting. Specialized machines, such as punch presses and shears for body blanks or cylinders, were invented and employed that expedited the cutting of metal -- bodies, tops, bottoms. Bench apparatus was also developed to rapidly solder these components together. While the devices of the "proto-mechanization" phase were rudimentary, they reduced the time spent on laborious tasks and increased productivity. Foot-operated slitters, or squaring shears, were a development of the 1840s. Previously, an operator had to scratch the outline of a can body on a sheet of tin plate using an awl. Once this was done, he used scissor shears to cut out the body. These hand operations could be inaccurate and often the result was a can body which was not square -- it lacked ninety degree corners. An out of square condition made forming the body cylinder, with a uniform circumference, a nearly

impossible task. The foot-operated squaring shear alleviated the inexactness of hand marking and cutting, and reduced the excessive time required for this operation. The foot-operated slitter had a table upon which the sheet of tin plate was placed by the operator. There were guides on the table which could be moved to the desired length or width of the body blank. The operator pushed the plate under the cutting blade until it hit his preset guide. He then stepped upon the pedal that actuated the cutting blade which moved downward and cut the plate. After cutting the desired number of strips, the machine was readjusted for the final cut, either length or width, and the operation repeated for the pile of strips. It took two passes through the foot-operated slitter to cut the final can body.

The foot-operated slitter, while not attributable to any one inventor, had a relatively long life as evidenced by an 1878 catalogue from Hall and Carpenter, a tin plate importer and equipment supplier in Philadelphia. The catalogue listed eight different types of foot-operated slitters available, ranging in price from \$40 to \$240, depending upon the maximum size capacity of the slitter table. Hall and Carpenter claimed their foot powered slitters, or squaring shears, "are arranged with gauges for squaring, stripping and cutting at any desired angle without the necessity of marking the sheet."³⁵ Although an elementary machine, the foot-operated slitter was the first machine applied to making a tin can.

³⁵ Hall and Carpenter. *Hall and Carpenter's Catalogue of Tinsmiths' Tools and Machines* (Philadelphia: Charles C. Douglas, 1878), 46. The comments regarding the operation of a foot powered slitter come from my personal notes of observing this device in production at a can-making plant in Baltimore during 2008.

An equally important invention, occurring nearly simultaneously as the foot-operated slitter, were presses for forming tops and bottoms. In 1847, Allen Taylor developed a foot-operated press for cutting or punching circular pieces of tinfoil from a sheet. Taylor's machine eliminated the requirement for a can-maker to use circular shears to cut tops and bottoms from a sheet, a time consuming and potentially error prone procedure. His press dropped a circular cutter, when the pedal was depressed by the operator, thereby stamping an end. The major drawback of Taylor's press was that force was only generated to stamp one circle of metal at a time, but it was still much more efficient than hand cutting. Taylor's press was improved upon by Henry Evans of Baltimore in 1849. Evans' designed a foot-operated pendulum press which generated more force by using a canted arm, the pendulum, which multiplied the kinetic energy of an operator's foot power. It thereby generated enough force to not only cut an end from a sheet of plate, but also to form a flange on the end. A Baltimore can-maker and friend of Evans, William Numsen, designed a combination die at the same time as Evans' pendulum press in 1849. Numsen's die was designed to cut, flange and punch the filling hole in one operation. When Numsen's die was used in conjunction with Evans' press, the production of finished ends could be accomplished in a single operation, quite an improvement over craft practices. Additionally, machine manufactured ends could easily be made large enough to fit over the outside of a cylinder, thereby allowing outside soldering of ends to the can, a much less time consuming operation than inside

soldering.³⁶ The rudimentary designs of Taylor, Evans, and Numsen were eventually improved upon by other innovators. Oberlin Smith and J.B. Wells of New Jersey owned a machinery repair business which specialized in can making equipment. Smith believed he could design a better foot-operated can press "than those he was called upon to fix." He began manufacturing foot-operated can presses in the 1860s and by the 1870s had invented a press which would draw or stretch the metal rather than cutting -- forming through pressure and the use of a die versus punching -- an improvement that resulted in more uniform ends and minimized wear and tear on dies. Smith's Ferracute Machine Company, of Bridgeton, New Jersey, became the leading manufacturer of can presses in the United States by the late 1870s.³⁷

The other realm of improvement during the "proto-mechanization" phase in can-making was improved bench tools for soldering side seams and ends of cans. Soldering mandrels, intended to stabilize the can while being hand-soldered, were attached to the can-maker's work bench. A bar was lowered and held in place with hand pressure to fix the overlapped ends of the body blank in place, while the can was soldered with the other hand. This method was soon improved upon with the design of a foot-operated device for holding the cans in place. The pedal feature fixed the can in place, which freed both hands for soldering and working the can seam.³⁸ A major step forward was

³⁶ H. S. Van Vleet, "Engineering the Tin Can," *Mechanical Engineering*, Vol. 70, No. 4 (April 1948), 315; W. H. H. Stevenson, "Cans and Can-Making Machinery," in Judge, *A History of the Canning Industry*, 92; May, 28-29; Busch, 96.

³⁷ Philip Scranton, *Endless Novelty: Specialty Production and American Industrialization, 1865-1925* (Princeton: Princeton University Press, 1997), 41-42.

³⁸ Clark, *The Tin Can Book*, 18; MacNaughtan, *Tin Plate and Tin Cans in the United States*, 85.

made in the 1850s with the design of the Jones Block, presumably by a man with the surname Jones. The Jones Block held the can in place and presented the side seam for soldering, using a lapped style seam, without the use of hand or foot power. A mandrel was attached to the workbench in a horizontal position with the open end of the cylinder facing the can-maker. The operator merely had to place a body blank around the mandrel and lower a clamp which held the metal in place. Spring tension, emanating from the action of the mandrel expanding when the clamp was lowered, held the can in place for soldering. He then soldered the seam with one hand while removing it from the device with the other. The great advantage of the Jones Block was that the mandrel was adjustable and could be used with any can diameter, unlike foot-operated devices for side seam soldering.³⁹

While most of the improvements in bench tools for soldering in the "proto-mechanization" phase were directed at the side seam, can-makers also began experimenting with rolling or rotating the ends in solder baths by the late 1850s. A pan of molten solder was affixed to the bench and the can simply rolled over it.⁴⁰ This practice only existed because of improvements in fabricating ends using the presses and dies of the 1840s which had the end flange on the outside of the can. However, this elementary process was the basis for innovations in end soldering occurring in the subsequent "semi-automatic mechanization" phase and represented a permanent transition away from inside soldering of ends in the "craft" phase of can-making.

³⁹ CMI, *The History of the Metal Can*, 5.

⁴⁰ MacNaughtan, *Tin Plate and Tin Cans in the United States*, 85.

An innovation which attempted to combine both side seam and end soldering in one bench tool was Hollingsworth's Can-Soldering Apparatus. In an 1867 *Scientific American* article, this device was presented as a machine that "will reduce the cost, by simplifying manufacturing." The product of an independent inventor, this device attempted to remove the dual constraints of side seam and end soldering. It was deemed as an invention that had many advantages, none of which were "trifling," and that held out the promise of "general utility." It contained a vertical mandrel for soldering the side seam, similar in operation to other devices, an improved furnace for melting the solder, a rosin tray, and a seaming apparatus. This last device was seen as the "main peculiarity" of Hollingsworth's invention. The soldered cylinder was placed in a cup which made a groove on the inside of the can. A treadle was activated by hand and brought an end down on the can, which was also grooved by a machine, and a snug fit made by with the aid of two pairs of knives. Once the end and body were secured through pressure, a second activation of the treadle dropped solder into the can. The can was then soldered on the inside by "floating" molten solder around the circumference of the can by rotating the cup. While *Scientific American* saw "great advantage" in Hollingsworth's Can-Soldering Apparatus, it was never a commercial success.⁴¹ Hollingsworth's machine added the additional processing steps of grooving the ends and can cylinder and relied upon inside soldering of the end to the can, which was becoming an obsolete process. Nevertheless, this invention demonstrated the

⁴¹ Unattributed, "Hollingsworth's Can-Soldering Apparatus," *Scientific American*, Volume XVI, Number 19 (May 11, 1867), 300.

need for machines which expedited attachment of tops and bottoms to cans.

The innovations of the "proto-mechanization" phase of can manufacture were substantial. Improved foot-operated machines for cutting plate and forming ends were significant advances from the days of craft manufacture. While the new bench devices for soldering side seams and ends to cans had limitations, they did improve throughput and also spurred further innovation which came to fruition in the next phase of technological development. By the late 1850s, each component of the can could be mechanically produced. By the mid to late 1860s, after the impact of new methods for cutting metal had diffused throughout the industry, can manufacturing rates were 60 cans per hour or 600 in a ten-hour work day.⁴² This was nearly a ten-fold improvement from craft practices.

Phase 3 - Semi-Automatic Manufacture

The "semi-automatic mechanization" phase corresponded with the "Golden Age" of can-making and canning in which technological innovations were made in rapid succession. There are three distinguishing characteristics of this phase of can-making mechanization. First, these were individual machines designed to perform a mechanical operation for a specific step of the production process. They were stand-alone machines in every aspect and were not linked to one another by conveyers or any other type of material handling device. Machines of this phase were seldom seen on a can-maker's workbench. Rather they were bolted on the floor; therefore, the size of the

⁴² Clark, *The Tin Can Book*, 18.

machines increased from previous devices. Second, the power or motive force for these machines progressed from human hand or foot power to power from a variety of sources: water, steam, or coal gas. These power sources ran the machines in the plant or provided the heat to melt solder. Human power was still very prevalent early in this phase, but it generally diminished, except for very small-scale firms. By the end of this phase, most can-makers had some sort of non-human, motive power in their shops. Finally, the capacity of can-making equipment increased dramatically. Many machines for end soldering, for example, may have begun with a capacity of one or two cans, but by the end of "semi-automatic mechanization" the capacity had increased by many multiples of the original models.

The transition from human to inanimate power began in the late 1860s and early 1870s and was first seen in the metal cutting innovations of the "proto-mechanization" phase. Slitters for cutting can bodies and end presses were offered by can-making equipment suppliers. Hall and Carpenter, a Philadelphia tinplate and can-making equipment supplier operating in the 1870s and 1880s, offered several styles of foot-operated squaring shears as previously mentioned. There were two makers of the foot-powered shear in their catalogue: Stow and Wilcox, both in New Jersey. Hall and Carpenter also offered, in the same catalogue, powered squaring shears from the same two manufacturers. The distinguishing mechanical difference between the foot-operated and powered shears was the replacement of the pedal feature with a shaft, flywheel, and two simple gears connected to the power source, possibly a small steam

engine. There were eleven models of Stow powered shears ranging in price from \$140 to \$600 per machine, but only one Wilcox model for large tin plate at \$800. The major economic distinction between foot-operated and electric powered slitters was price. A Stow foot-operated No. 25 shear capable of cutting 25 inch plate, a common size for can-makers, was \$48. However, the similar Stow electric powered machine, model No. 025, listed for \$160. Capacities for each type of shear were not mentioned in the catalogue, but it is reasonable to surmise the powered shears were much faster than foot-operated models, plus they eliminated workers.⁴³ Nevertheless, the substantial price difference between the types of machines made their purchase a critical decision for a can-maker and a component in their diffusion. Larger can-makers would be more likely customers for the powered machines because they had a need for more capacity and could afford them, while smaller, seasonal, self-manufacturers would opt for the less expensive foot-operated machine.⁴⁴

The transition away from foot-operated power also occurred with end presses. The foremost early manufacturer of end presses, Oberlin Smith's Ferracute Machine Company of Bridgeton, New Jersey, offered seven models of foot-operated and three types of powered end presses for can manufacturers in their catalogue from the early

⁴³ Hall and Carpenter, *Catalogue of Tinsmiths' Tools and Machines*, 46-48.

⁴⁴ Throughout the late nineteenth century and the first two decades of the twentieth century, steam engines were the predominant energy source for powered machinery in canneries and can manufacturing plants. The energy generated through a steam engine was linked to canning and can-making equipment through a series of linear shafts and flywheels. Electricity, whether purchased from a public utility or privately generated on the premises of a cannery or can-making factory, became the leading energy source by the mid-1920s. For additional information see U. S. Department of Commerce, Bureau of the Census, *Census of Manufactures 1927* (Washington, D.C.: GPO, 1930), 64.

1880s. The presses were vastly different in mechanical construction. The foot-operated required the operator to manually insert plate for making an end into the die area with his hand, while the powered had a semi-automatic feeding mechanism which avoided the dangerous practice of sticking a hand under the die. The foot-operated functioned by merely stepping on the pedal, while the powered had a flywheel which moved the single combination die down upon the plate. Additionally, the powered models were equipped with a foot brake to stop the press in case of a jam. The Ferracuta Press 223 was "suitable for any work up to and including 3 lb. 'combination' dies." This range of capability encompassed the most common sizes of tin cans. The number of strokes per minute was variable and depended upon the dexterity of the operator, but 20 ends per minute seems reasonable. This press was priced at \$50. A comparable powered press, Ferracuta Press 1, was "suitable" for fruit and vegetable cans up to 3 lbs and was priced at \$120. This press operated at a speed of "about 120 revolutions a minute," meaning it produced 120 ends a minute.⁴⁵ While more expensive than a foot-operated press, it produced six times as many ends in the same amount of time. The factors for adaptation of powered end presses by can-makers were the volume of their operation and available capital, as was the case with slitters.

The portion of the can-making process that received the most attention in the "semi-automatic mechanization" phase was end attachment. The seaming operation

⁴⁵ Ferracuta Machine Company, *Catalogue "D": Illustrated Catalogue and Price List of Presses, Dies, Can Makers' Machinery and other Sheet Metal Tools* (Bridgeton, N.J.: Ferracuta Machine Company, 1885), 8-11, 51-55.

remained problematic for can-makers because the fit of the end had to be tight when soldering, either inside or outside, and end seaming consumed the greatest amount of solder. The amount of solder used in the manual process varied according to the individual can-maker. A more efficient process that produced a more secure seam, expedited production, and consumed less solder was highly desirable. The first major improvement in end soldering, the Howe Floater, occurred in 1876. Named after the independent inventor James Howe, it was a stand-alone machine. The operator, normally a young apprentice, would snap an end around the outside of a soldered cylinder. The seam was completed by placing the can in the "floater," consisting of a long trough of molten solder along which the cans were rolled by a chain conveyor. The can was placed at an angle of 22 degrees from horizontal and this orientation was maintained by the back plate of the Howe Floater throughout the seaming operation.⁴⁶ This was a relatively high-capacity, two-person machine, with a young apprentice to snap on the ends and a mechanic to maintain the operation of the machine. The capacity of the machine depended upon the length of the trough, but 1,500 cans in a ten-hour day was the norm.⁴⁷ A major step forward in end seaming, the Howe Floater was powered, high-capacity, and quite expensive. It was offered in Ferracute's 1885 catalogue "furnished at manufacturers price" for \$350, "including royalty of \$200."⁴⁸ Only the largest can-makers could afford this machine, so many alternatives based upon

⁴⁶ Busch, "An Introduction to the Tin Can," 97; Van Vleet, "Engineering the Tin Can," 315; May, *The Canning Clan*, 28.

⁴⁷ Kee, *Saving Our Harvest*, 41.

⁴⁸ Ferracute Machine Company, *Catalogue "D"*, 67.

the principles of the Howe Floater entered the market to serve smaller manufacturers.

While the Howe Floater was the eventual direction taken by large can-makers for end soldering, the appearance in 1880 of the Merriam "Little Joker" was intended for use by smaller can-making operations. It operated on a similar principle as the Howe Floater, rotating the cans in molten solder on the outside of the can, but it was a hand operation.⁴⁹ Merriam's initial design, Merriam Floater No. 1, was nothing more than a device with an angled back plate and small pot of solder, fastened to a bench (see figure 3.4). The power source to melt the solder in the pot was "coal gas," also known as "street gas," or gasoline. There were lines and valves attached the floater to keep the solder in a liquid state. The cans were rotated by hand and the operation was so elementary, "any bright, intelligent boy or girl, 14 to 16 years of age, can soon learn to operate it," according to the advertisement by can supplier E. F. Kirwan of Baltimore. The daily capacity, for a ten-hour day, was 1,500 to 1,800 cans. The price was \$25 per machine.⁵⁰ The improved Merriam Floater No. 2, also bench attached, had a capacity of 2,000 to 2,500 cans per day and was distinguished by a hand crank or roller attachment to rotate the cans. E.F. Kirwan extolled the many advantages of this machine, one of

⁴⁹ May, *The Canning Clan*, 28; Busch, "An Introduction to the Tin Can," 97. The terms "joking" and "floating" refer to solder application to can ends. Floating initially was the tinsmith's technique of dropping a piece of solder in a can, applying a soldering iron to melt it, and rolling it about the interior of the can to get proper flow of the solder. Joking was the term generally adopted for the process of soldering ends on the outside of the can. However, often "joking" and "floating" were interchangeable terms for soldering ends to cans.

⁵⁰ E. F. Kirwan, *Catalogue of Cans, Machinery and General Canning House Supplies* (Baltimore: The Friedenwald Company, 1890), 95.

which was "no fear of strikes, as green help can be taught in a few hours."⁵¹ A competitor, and copier of the Merriam Floater, was the Triumph Can Floater at \$17.50. It was also a hand-operated device and it claimed to make "stronger joints than can be made by any known process" using "12 oz. less [solder] than is used by any other floaters." It is interesting to note that, according to this catalogue advertisement, 12 to 13 ounces of solder were required to seal 100 #3 cans, versus 28 ounces for inside soldering of the same quantity of cans. A great advantage of outside soldering ends was the solder savings of over 50 percent.⁵²

The single head floaters were certainly a major productivity improvement for attaching ends, but increasing demand required even larger machines. The Ayars Machine Company of Salem, New Jersey developed a multi-head machine in the late 1880s named "The Little Giant." Not attached to a bench, this floater was a separate machine bolted to the floor. It could be operated by either human or other power sources and could seam up to four cans at a time. Its daily capacity was 5,000 to 7,000 cans per day and it required only two people to operate it: "one boy to rosin and place the cans in the feed" and "a man to turn the machine [hand-operated] and take the cans out with the seam down." If a can-maker's requirements exceeded the 5,000 to 7,000 a day for a hand-operated machine, Ayars claimed 18,000 to 20,000 cans per day could be produced by "two (2) machines with power . . . operated by a feeder chute so that the cans can be fed automatically into the machine." Prices for the Ayars "Little Giant" were

⁵¹ Ibid., 96.

⁵² Ibid., 97.

only "quoted on application."⁵³ By the end of the 1880s, the basic principles for end soldering were established within the industry. First, cans were to be soldered on the outside using a floater. Inside soldering was now considered an outdated, slow, and wasteful process, which produced an inferior tin can. Second, the type floater, whether single or multi-head, hand-operated or powered, depended upon the size of the firm, capital funding, labor supply, and power source preference. This machine was suitable for any size can-making firm. The next change of end attachment technology would not occur until the forthcoming radical changes of the "product design" phase of technological development.

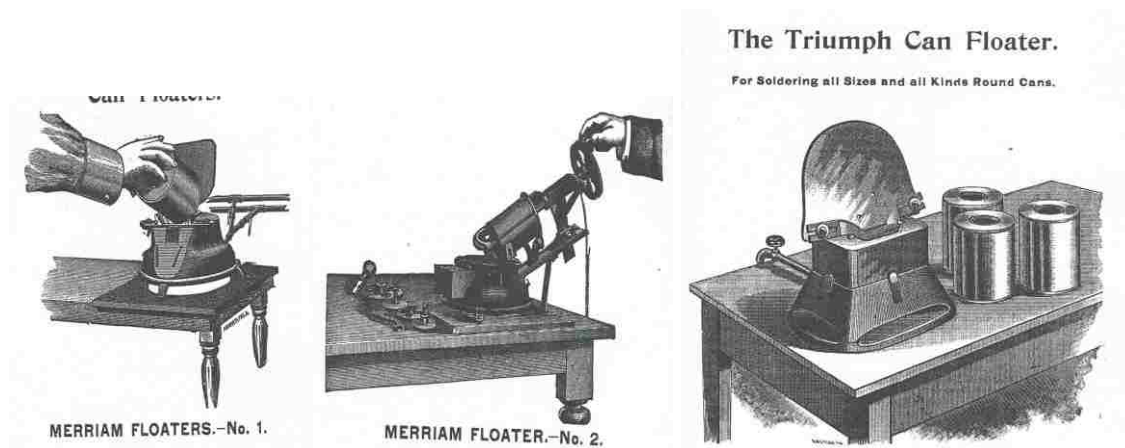

Figure 3.4 - Various End Floaters - Merriam's and Triumph. Taken from E. F. Kirwan Manufacturing Company, *Catalogue of Cans, Machinery, and General Canning House Supplies*, 95-97.

⁵³ Ayars Machine Company, *Catalogue of Presses, Dies, Can-Making Tools, Can-Filling Machines, Platform Conveyors, and Supplies* (Salem, N.J.: Ayars Machine Company, 1900), 20-21.

While end attachment garnered much innovative energy during the "semi-automatic mechanization" phase of can-making technology, improved methods of side seaming and body-making also increased productivity. The bench device named the Jones Block from the "proto-mechanization" phase served as the basis of innovation. By the early 1870s, can-makers achieved rates of 60 cans per hour using a single Jones Block, and multiples of this figure when several were employed in can-making. This device produced a lapped side seam, meaning the ends of the body were overlapped and held in place by a spring-pressured clamp, while the can-maker soldered them. The next innovation after the Jones Block was the turret body maker. The turret body maker was, in essence, several Jones Blocks arranged vertically and set upon a circular table. It required two persons to operate it: an assistant to roll bodies and remove soldered cans and an operator to solder the containers. An assistant would roll body blanks and form cylinders by passing them through a manually operated rolling machine. The rolled, but unsoldered cylinders, would be hand-fed by the assistant and placed upon several soldering mandrels or horns on the circular table. The table could be revolved by the operator through the use of a pedal. The can-maker would solder the lapped seam on the outside, depress the pedal, pass along the finished can, and an unfinished body was presented by the turret. The finished cans were removed by the assistant. The standard turret body maker could produce 2,500 bodies per hour, a pace much faster than end soldering systems.⁵⁴ The turret style body maker was not the

⁵⁴ May, *The Canning Clan*, 91-92.

production constraint in can manufacturing, it was still end soldering at roughly 1,500 cans per hour. As a result, the turret style body maker was the only significant mechanical development for side seaming in the "semi-automatic mechanization" phase.

There were drawbacks to the lapped seam, regardless of whether they were soldered on the inside or outside, as this 1886 patent application emphasized:

The seams of sheet-metal cans have heretofore usually been soldered by applying the solder to one side or the other of the seam. Where the solder is applied to the seam upon the inside of the can, objection has been made by reason of the contents of the can coming in contact with the exposed solder. Where the solder is applied to the seam from the outside of the can, the solder is always more or less smeared over the outside of the can and seam, and the exposed solder renders the can unsightly in appearance.⁵⁵

The imperfections of lapped seams were twofold: uneven manual application of solder and the lack of a robust seam. One result of these deficiencies was that the style of side seam began changing during the "semi-automatic mechanization" phase of technological change. The lapped seam was most prevalent prior to the 1880s, however some can-makers began experimenting with "locked seams" as early as 1869. This style of seam received nominal attention during the 1870s and 1880s and was only popularized in the late 1880s and 1890s when body-making became the process limitation.⁵⁶ The lock seam folded the edges of the can body slightly while the cylinder was formed to make two hooks, then crimped the edges together by applying slight

⁵⁵ Edwin and Oliver W. Norton. 1887. Sheet-Metal Can and the Art of Manufacturing the Same. U. S. Patent 370,404, filed December 18, 1886, issued September 27, 1887.

⁵⁶ CMI, *The History of the Metal Can*, 5; Van Vleet, "Engineering the Tin Can," 315; MacNaughtan, *Tin Plate and Tin Cans in the United States*, 85.

pressure to the seam. The result was a folded seam consisting of four layers of metal, versus the standard lapped seam which only had two layers. The lock seam was then soldered, most often on the outside. However, until body-making and soldering became the bottleneck in production, minimal attention was placed by inventors on this area of can-making.

An early quality concern was leaking cans and this problem was initially addressed during the "semi-automatic mechanization" phase of technological development. Imperfect end or side seams were the scourge of can-makers in the nineteenth century and remain today the central quality concern of metal packaging companies. Leaking cans, known as "leakers," allowed air inside the cans and spoiled the product, while the contents of the can could seep out through the imperfection and potentially ruin other packed product. Either condition could lead to costly claims against the canner and can supplier. While some can makers, prior to the 1880s, had attempted to test cans by injecting compressed air into them, the method was inherently unreliable because of deficiencies in sealing the can while testing and the inability to "indicate the precise location of a leak in a can." Leaking cans were first systematically and successfully addressed by physician and independent inventor Dr. William B. Mann, of Baltimore, in 1882. Dr. Mann was awarded U. S. Patent 265,837 on October 10, 1882 for his "Process of and Apparatus for Testing Cans." Mann's invention was specifically for "testing sheet-metal packages or cans used in packing that class of materials known as 'hermetically-sealed goods'." His tester consisted of an apparatus of

four heads connected to a rotating shaft into which cans were clamped and sealed at their top with a rubber gasket. Warmed compressed air was injected into the four heads once the cans were clamped in place and the apparatus was rotated and immersed the cans in a bath of hot water. While submerged, air bubbles would appear at the point of any leaks. The operator would then stop the machine when he identified a leaker, remove the defective can, and indicate the area of leakage on the can with a grease pencil. The leakers were then returned for rework to a can-maker. Each can would be passed through Mann's tester, but the clamping of the cans, the process of immersion and rotation, and removal of any defects were manual operations. His original machine was not integrated with any other portion of the can-making process. Mann claimed originality for "the process . . . for testing sheet-metal cans," his "mechanism to clamp the cans and connect them with a compressed-air supply," the "combination of a water-tank, a revolving shaft . . . with an air reservoir," and the idea of heating both the compressed air and water.⁵⁷ The limited capacity of his original four-headed model was overcome when can-makers installed multiple testers.

Mann's basic design would be improved upon in later stages of technological development by other independent inventors, but the resilience and longevity of his innovation is indicated by industry trade publications. The E. F. Kirwan catalogue of 1890 sold a single Mann tester, with gasoline tank and burner, for \$95. A can-maker could also purchase additional air pumps, tanks, gauges and safety valves to increase

⁵⁷ William B. Mann. 1882. Process of and Apparatus for Testing Cans. U. S. Patent 265,837, filed June 29, 1882, issued October 10, 1882.

throughput. A system of three testers, with all ancillary equipment, was available for \$200. The Kirwan catalogue claimed "the minutest leaks are readily discovered by air bubbles showing in passing through the water" and a single machine could test "from 5000 to 6000 cans per day." The Kirwan catalogue also sold an "improved" version of Mann's tester for \$100, and claimed it was so simple that it could be operated by "a smart boy."⁵⁸ The Ayars Machine Company catalogue of 1900 also sold versions of Mann's "improved" testers for \$85, so the price had decreased over the decade. Ayars claimed "the finest possible leakage can be detected, and again the machine was so rudimentary it could be operated by "a smart boy."⁵⁹ Mann's testers operated more slowly than other portions of the can-making operation, so multiple units were in operation in larger facilities. Future Mann testers had a capacity of 10,000 to 15,000 in a ten-hour day, but these rates were not reached until the late 1890s. By the 1910s, Stevenson and Company, a direct competitor of Mann and a can machinery supplier, was manufacturing testers with a capacity of 60,000 to 65,000 a day using a larger tank and a chain conveyor.⁶⁰ Versions of Mann's original idea for water immersed air testers are still used to selectively high-pressure test food cans in many contemporary can manufacturing facilities.

⁵⁸ E. F. Kirwan, *Catalogue of Cans, Machinery, and General Canning House Supplies*, 101-102.

⁵⁹ Ayars Machine Company, *Catalogue of Presses, Dies, Can-Making Tools*, 19.

⁶⁰ W. H. H. Stevenson, "Cans and Can-Making Machinery," in Judge, *A History of the Canning Industry*, 92.

Domestic Tin Plate Production

The multitude of semi-automatic machines used in can-making after the Civil War would have been impossible without advances in allied industries, such as steel making and tin plating. The need for speed was of paramount importance for can-making, but could only be achieved with a more uniform substrate -- steel. The conversion from iron to steel as the base substrate for the tin can began in the 1850s with the Bessemer process. This new process introduced a blast of hot air into the bottom of the converter, keeping the iron molten while burning out the unwanted carbon, and made higher temperatures possible. The higher temperatures aided steelmakers in eliminating unwanted carbon from the iron. The resultant product was stronger than iron and was much more malleable and ductile, properties of interest to can-makers who desired thin plate. The introduction of open-hearth process, which produced better steel, in the 1870s also assisted can-makers. Production quantities of steel, using either the Bessemer or open-hearth processes, greatly increased output for steelmakers.⁶¹

By the late nineteenth century, there were two processes for tin plating steel. The original process of hand dipping and polishing the plate with grain and sawdust was still prevalent, but the rolling process for tin coating had become much more common by the 1880s. One tin plate supplier, Merchant and Company of Philadelphia, described the rolling process in their 1880 catalogue. They claimed the rolling process was

⁶¹ Robert Skemp, *The Evolution of a Tin Can, with a Brief Introduction on the Manufacture of Iron and Steel* (Pittsburgh: American Sheet and Tinplate Company, 1928), 6-10, 17-21; Busch, 97.

"generally used" and that "the plates are dipped in the coating [molten tin] and then passed through rollers to equalize the coating on the surface; and also to reduce the coating, and thus cheapen the plate." They commented on the inferiority of hand-dipped plate and argued that "hand dipping, without rolling, leaves a heavier coating, and plates furnished under it are today called old-style."⁶² The primary deposits of tin were in Wales, Malaya, and Australia, so the tin plate consumed by American can manufacturers was predominantly imported from Wales prior to the 1890s.⁶³

In the United States, commercial tinplating began in 1873, but most tinplate used in can manufacture was still imported. According to labor historian David Brody, steel making had been improving in most areas, yet "only sheet and tin plate resisted improvement." Brody also argued that "the McKinley Tariff opened the field [tin plate production] to Americans."⁶⁴ The McKinley Tariff was championed by Congressman and future President William McKinley, and officially referred to as The Tariff Act of 1890. The legislation raised the import duties on tin plate to nearly fifty percent. The intention of the Act was to protect the nascent American tin plate industry and provide conditions in which it could flourish. The meteoric rise in consumption of tin plate was driven by the exponential growth of the canning industry.⁶⁵ The McKinley Tariff had an

⁶² Merchant and Company, *Price List of Merchant and Company* (Philadelphia: A. C. Bryson, 1880), 31.

⁶³ Skemp, *The Evolution of a Tin Can*, 17.

⁶⁴ David Brody, *Steelworkers in America: The Nonunion Era* (Urbana: The University of Illinois Press, 1998 (1960)), 13.

⁶⁵ CMI, *History of the Metal Can*, 4.

immediate effect on the fledgling American industry, as demonstrated by the figures below.

Table 3.2 - American Tin Plate Consumption

Year	Total Consumption (tons)	Foreign Origin (tons)	Domestic Origin (tons)	Percent (%) Foreign Origin	Percent (%) Domestic Origin
1889	370,078	370,078	0	100	0
1899	490,649	65,796	424,853	13.4	86.6
1904	586,165	78,540	507,625	13.4	86.6
1909	731,194	70,089	661,105	9.6	90.4
1914	977,474	17,186	960,288	1.8	98.2

Source: Data converted from pounds to tons and taken from U. S. Department of Commerce, *Census of Manufactures, 1914*, Part II - Reports for Selected Industries and Detail Statistics for Industries, by States (Washington, D.C.: GPO, 1919), 260.

The major customer for tin plate was the canning industry and the consumption of tin plate nearly tripled from 1889 to 1914. The protectionist umbrella of the McKinley Tariff allowed a non-existent industry in the 1880s to completely dominate and nearly eliminate any imported tin plate in the course of twenty-five years.

Adoption of Technology by Can-Makers

The plethora of new machines and processes for manufacturing tin cans were adopted for a variety of reasons, and diffusion depended upon a number of factors. From the early 1870s until the late 1890s, diffusion of machines throughout the canning industry was incomplete. The new can-making machines were readily adopted by firms specializing in making cans. Self-manufacturing firms generally adopted machines to improve productivity or assert control of the shop floor. The desire to increase

productivity was understandable and somewhat obvious, but the impulse to avoid labor disputes seemed concentrated in the can-making and canning center of the nineteenth century -- Baltimore. In its canning plants, there were strikes and great opposition to machine-made cans from skilled workers who had formerly made them by hand. However, these strikes "did not materially retard the continued acceptance of machine-assembling and sealing of cans."⁶⁶ Machine-made cans were quite popular in Baltimore because of the concentration of firms specializing in can manufacturing and the generally large quantities of products packed year round by canners in the city. Some Baltimore canning firms no longer made their own cans and purchased them from specialist firms focused only on can-making. Outside Baltimore, however, there was slower adoption of machines for making cans and the machine-made can. By the early 1890s, most cans used in the primary canning locations in upstate New York were still made by hand, yet there was an increasing reliance on specialist can companies for common sizes, such as #2, #2½, and #3, while the canning companies continued to make the larger sizes by hand. Dr. Edward F. Keuchel, a food historian, estimated that canners and can-makers located outside Baltimore were generally ten years behind the city in adoption of technology.⁶⁷

The decision whether to adopt new can-making technologies was often a product of the local environment and business considerations, as argued by Dianne Newell, in her 1988 article "The Rationality of Mechanization in the Pacific Salmon-

⁶⁶ Keuchel, "The Development of the Canning Industry in New York State," 77.

⁶⁷ *Ibid.*, 80-82.

Canning Industry before the Second World War." While the thrust of her article and argument concerned salmon canners, the issues raised are applicable to fruit and vegetable canners, as well as can-makers. Newell argued that labor scarcity was not a major impediment for technological adaptation by salmon canners, as adequate numbers of Chinese immigrants, as well as Native peoples were available to work the canning lines. Even though the labor system was highly adaptable, she argued that it was a variable cost which could be reduced via mechanization.⁶⁸ A similar argument could be made by can-makers. If adequate labor was available locally, mechanization was not necessarily a rational choice, but offered the prospect of lower labor costs. However, if local labor was scarce, mechanization was a rational choice and often the only alternative because of the paucity of skilled labor.

Newell contended that factors such as the capital cost of machines, maintenance for the machines, the seasonal nature of many canneries resulting in machine idle time during the year, the large number of small canners in the market, and the isolated location of many of these firms often were factors that affected the degree of mechanization by salmon canners.⁶⁹ These same factors extended as well to can manufacturing. Small and seasonal vegetable or fruit packers would be less likely to adopt machines for making cans and preferred to make their own by hand or buy them from a firm specializing in manufacturing cans. Machines were simply too costly and

⁶⁸ Dianne Newell, "The Rationality of Mechanization in the Pacific Salmon-Canning Industry before the Second World War," *The Business History Review*, Vol. 62, No. 4 (Winter 1988), 639.

⁶⁹ *Ibid.*, 642, 654.

under-utilized in these circumstances. It is reasonable to conclude that can-making machinery was first adopted by those firms specializing in can-making as these firms had an economic incentive to manufacture cans for less than it cost a canner to make them himself. The next group of firms that mechanized were the larger canners who had adequate volumes, packed year round, wished to avoid labor disputes, or desired to lower their labor costs. This group still had enough requirements for cans to make buying them an expense they could lower through self-manufacture. The last group of firms to mechanize, if they even chose to do so, were small canners operating a highly seasonal operation.

Labor Relations Issues

An important piece of equipment on the canning line, and one which generated many labor disputes, was the capping machine. The genesis of this controversy came from the "boss capper" and his struggle with plant management over control of the shop floor. The boss capper was an inside contractor to the canning firm, and he provided a crew of skilled employees to solder the caps to the hole-in-cap can, after it was filled. Next to the supervisor for production, the person responsible for monitoring the fruits and vegetables while they cooked, the capper was the most skilled position on a canning line. Cannery owners would hire a crew of cappers from the boss capper during packing season.⁷⁰ This was a flexible labor strategy for slow periods of the year

⁷⁰ Edward F. Keuchel, "Master of the Art of Canning: Baltimore, 1860-1900," *Maryland Historical Magazine*, Vol. 67, No. 4 (Winter 1972), 359-360.

and alleviated the necessity of cannery owners to carry more skilled employees on their payroll. A slightly less skilled employee was the "tipper," or the person who dabbed a drop of solder on the vent hole of the cap, after cooling. Boss cappers often engaged in work stoppages or strikes just prior to or during the packing season and would return only when their demands, often for higher wages, were met by cannery owners. Cappers were amongst the highest paid skilled employees of the 1880s cannery. One canning industry proponent alleged that boss cappers were "obsessed with this power" and they "declared strikes in the canneries of owners who refused their demands."⁷¹ The advent of capping machines made capping and tipping obsolete positions within a canning plant.

In the 1880s and 1890s there were two principle manufacturers of capping machines: Cox and Hawkins, although there were other manufacturers of capping machines, such as Jones, Norton, and A. K. Robins. The machines varied slightly in design, but the basic principles were the same. Rather than manually placing and soldering the cap on the can with a soldering iron, the process was performed mechanically. An arm from the machine would wipe the surface clean and apply flux around the hole in the top of the can in preparation for the solder. A feed mechanism would place a cap upon the hole in the can, while solder from a continuous trough was applied around the cap. A heated device known as a "capping steel" served the same function as a soldering iron. It was lowered, by hand crank, foot treadle, or later

⁷¹ May, *The Canning Clan*, 29.

automatically once the tray containing the cans entered the capper. The can was sealed through the heat of the capping steel attaching the cap to the top of the can by using the flowing solder. The A. K. Robins machine was a single head capper and built for "small packers or small capacities." It could cap cans ranging in size from #1 to #10 and had a capacity of 5,000 to 6,000 cans per day. Once again, the machine was advertised as so elementary a "boy or girl" could operate it and "expert help" was "not required." The machine sold for \$150.⁷² The Jones capper, introduced in Baltimore by the mid-1880s, was a multi-head machine which could simultaneously cap six cans at a time.⁷³ Obviously, even the rudimentary Robins single-head capper was a threat to skilled hand-cappers.

The Cox and Hawkins cappers became the mainstay of the canning industry due to their high capacity, reliability, and flexibility. Cox, Brother and Company was based in Bridgeton, New Jersey. Their 1900 catalogue offered three types of machines: a 12-steel [head] power [natural gas] capper, a 6-steel power capper, and a 12-steel hand capper. The 12-steel hand-capper occupied twelve square feet of floor space, could cap all common sizes of cans up to #3, had capacity of 1,800 cans per hour, and was specifically designed for "the smaller packer." The 12-steel and 6-steel powered cappers, designed for larger canning operations, were billed as modern and economical, and extremely high capacity machines. Cox claimed the 12-steel power capper had met

⁷² A. K. Robins and Company, *Catalogue of Canning Machines and Cannery Supplies* (Baltimore: A. K. Robins and Company, 1920), 227.

⁷³ Keuchel, "Master of the Art of Canning," 359.

with "phenomenal success" with "never a machine returned from the first one put out." The 12-steel machine had a capacity of 50,000 cans in a ten hour day, and it capped common sizes up to #3. The machine listed for \$600, and the company claimed it would cost a canner \$1000 for any other two capping machines on the market to match this capacity. The 6-steel power machine was a smaller version of the 12-steel power capper and could cap 25,000 cans a day. It was designed for "parties requiring a machine of moderate capacity."⁷⁴ The Hawkins Machine Company offered similar hand and powered 12-steel capping machines as Cox, but they had two models: "standard" and "universal." The "standard" machine was specifically for #2 and #3 cans, while the "universal" model could cap cans up to #3. The capacity was similar, 50,000 in a ten-hour day, but the prices were higher than Cox's machines. The "standard" machine, complete with an attachment for tipping, retailed for \$750, while the "universal" capper, similarly equipped, cost \$1,000. The manufacturer also claimed "the consumption of gas is highly economical, owing to the special arrangement of burners."⁷⁵ Interestingly, neither Cox nor Hawkins claimed their cappers were so simple a boy or girl could operate them. The primary emphasis in their catalogue advertisements was the cost savings their machines provided, either through increased capacity or lower consumption of materials such as coal gas or solder.

Workers' acceptance of machines and mechanization in general was not

⁷⁴ Cox, Brother and Company, *Catalogue No. 4, Cannery Machinery Manufactured and for Sale by Cox, Bro. & Co.* (Elmer, N.J.: Times Print, 1900), 3-5, 32-35.

⁷⁵ Sprague Canning Machinery Company, *Sprague General Catalogue of Canning Machinery and Supplies* (Chicago: Sprague Canning Machinery Company, 1913), 352-353.

universal. There was significant resistance from skilled workers, specifically cappers, whose positions or wages were endangered by mechanization of can-making. The backlash against mechanization began in the 1870s and continued through the 1890s and was most severe during the "semi-automatic mechanization" phase of technological development. A twentieth-century government study of late nineteenth-century canning reiterated this point. The Pennsylvania study stated "the introduction of this labor-saving machinery was not without attendant labor difficulties. This was particularly true in the case of the cappers. They could earn as much as \$14 per day during the season when the average worker was lucky to receive \$1.00 to \$1.25 for a long day's work."⁷⁶ While government documentation of wage losses identified an understandable concern of workers, some canning industry insiders engaged in hyperbole. Earl Chapin May, in his 1937 hagiography, *The Canning Clan*, made outrageous claims on worker reactions to mechanization. May recounted an incident where a Baltimore canner only saved his machines "by holding the boss capper at bay with a loaded revolver. That night his factory was broken into, and the Cox capper thoroughly smashed by hand workers." May stated that canneries were "burned unless they were guarded" and that "assassinations were nightly and sometimes daily incidents."⁷⁷ Undoubtedly there was disagreement, and possibly violence, over the introduction of machines, but there exists no evidence to support May's claim of labor

⁷⁶ Commonwealth of Pennsylvania, *The Canning Industry in Pennsylvania: Origin Growth and Important Characteristics*. Prepared by the Research and Statistics Division of the Bureau of Employment and Unemployment Compensation (Harrisburg, Pa.: Commonwealth of Pennsylvania, 1949), 2.

⁷⁷ May, *The Canning Clan*, 30.

discontent on the level he portrayed.

Deskilling of can-making and capping jobs was just as important a concern of workers as was any loss of their positions. A can-maker could employ machines to deskill labor and make it less costly, though not necessarily eliminating it. The previously mentioned trade catalogue advertisements, such as the one for a Mann tester offered by Ayars Machine Company, stated that it could be operated by "a smart boy." Obviously a "smart boy" was less costly to a can-maker than a skilled worker and might potentially be more readily available than adult labor in rural areas. Can-makers and cappers saw even more significant mechanization and subsequent deskilling and elimination of jobs on the horizon. The Cox capping machine and floaters, such as Merriam or Triumph, especially threatened cappers and can-makers, respectively. One story from Baltimore, which might be apocryphal, was that some canners and can-makers in Baltimore equipped large rooms with unused soldering machines. The soldering machine capacity was five times that of hand can-makers, therefore the equipment was purchased just for the purpose of "intimidating can shop personnel" according to the account.⁷⁸ Scholarly research by Martin Brown and Peter Philips, economic historians, concluded in their 1986 article that there were two paths canners and can-makers followed to reduce costs. First was mechanical devices designed to replace unskilled labor. Second, and more importantly, were machines to deskill craft labor and make it more replaceable and less expensive. Brown and Philips claimed that

⁷⁸ Edward F. Heite, *Archaeological Data Recovery on the Collins, Geddes Cannery Site* (Dover, Del.: Delaware Division of Highways, 1990), 20.

the Cox capper did not necessarily increase productivity, but it reduced labor costs by using less skilled workers -- remember the "smart boy." They provided data to substantiate that mechanization increased productivity throughout a canning plant, yet unskilled productivity increased greater than skilled. However, the wages for skilled labor decreased dramatically. A capper made \$3 a day in 1865, but due to deskilling this rate had declined to \$1.44 by 1894, yet his production rate had doubled. Deskilling came before job elimination, they argued, and "when a machine can cut wages through deskilling, this skill-saving machine may be introduced before its perfection as a labor-saving device."⁷⁹ There were certainly some can-makers and canners who harbored a benign wish for greater productivity and throughput, but the desire to decrease costs through job elimination or deskilling of crafts was also a factor in their decision to adopt machinery.

One reaction by workers threatened by mechanization was to organize. The most significant organization activities were in the Baltimore area, and their target was the elimination or deskilling of jobs through increased use of machinery. It was a fight for control of the shop floor. There was loose organization of hand can-makers in the 1870s, but labor was formerly organized in the Baltimore area in 1883 as part of the Knights of Labor. Local 1384 of the Knights of Labor was composed of hand can-makers and cappers and became known as the Can Makers Mutual Protective Association or the CMMPA. This organization conducted successful strikes and machinery boycotts. They

⁷⁹ Martin Brown and Peter Philips, "Craft Labor and Mechanization in Nineteenth-Century American Canning," *The Journal of Economic History*, Vol. 46, No. 3 (September 1986), 746, 749, 751-754.

also conducted a public relations campaign against machine-made cans specifically and machinery in general. Their public relations campaign warned consumers of the dangers inherent in machine-made cans from the zinc chloride used as flux, prior to soldering, instead of rosin as practiced by hand-made can-makers. The CMMPA claimed zinc chloride contaminated the contents of the can and caused illness. It advertised in newspapers, on buildings, and distributed circulars. The CMMPA took its case to the Maryland Legislature and sought action which banned the use of machine-made cans. Their case was ultimately rejected by the Maryland Legislature, and the public in general, but the use of zinc chloride by can-makers was discontinued and subsequently replaced by other materials. The CMMPA became a viable union with membership listed at over 1,200. However, an unsuccessful May 1886 strike for a shorter workday and less use of mechanization, combined with the slow demise of the Knights of Labor, hastened its downfall. The CMMPA failed to prevent increased use of machine-made cans, and membership rapidly declined. By 1896 the CMMPA Local 1384 included less than 200 members and their influence had waned.⁸⁰ The machine-made can was now a part of the American cupboard, and the can-making workforce had begun to shrink in the mid-1880s.

By the mid-1880s, can production had increased dramatically from the "proto-mechanization" era. At the end of the "semi-automatic" phase of development, can

⁸⁰ W. H. H. Stevenson, "Cans and Can-Making Machinery," in Judge, *A History of the Canning Industry*, 92-93; Keuchel, "The Development of the Canning Industry in New York State," 74-79; Keuchel, "Master of the Art of Canning," 359-362.

production rates had increased over four times from thirty years earlier. Can production rates were 1,500 cans per day in 1880 using some of the initial developments of mechanization.⁸¹ By 1890, improved versions of machines for soldering ends and bodies averaged 2,500 cans per day.⁸² These were substantial improvements from the daily rate of 600 cans per ten-hour day at the end of the "proto-mechanization" phase. However, the first generation of machines still had major limitations. First, they were stand-alone machines, not linked together in any fashion. Most canners still manufactured their own cans in the 1880s, therefore, they had a need for a systems approach to can manufacturing to increase output, rather than just maximizing the output of individual machines. Second, throughput on canning lines, via innovations such as the Shriver Retort and capping machines, was much greater than the rate of can manufacturing. This situation demanded faster can assembly through systematization and machines with greater capacity. There was also a realization by cannery owners that can-making was becoming a specialty, and their interests might be better served by outsourcing can manufacturing and concentrating their efforts on filling, processing, and selling their products. Systematization of can assembly began in the 1880s. Further growth of canning depended on expedited can manufacture.

⁸¹ Hampe and Wittenberg, *The Lifeline of America*, 119; Kee, *Saving Our Harvest*, 41.

⁸² CMI, *The History of the Metal Can*, 5.

Phase 4 - Integration and Emergence of a New Industry

The "integration" phase built upon the prior development of individual, special purpose machines. By the 1880s, there were specialized machines for each step of the can assembly operation. The most significant technological development of this phase was that individual machines were linked together through systems of material handling devices to form a continuous process line for the production of cans. As the machines became incorporated into a system, subsequent developments also made them faster and more resistant to process variation – the cans were more uniformly constructed. The objectives in this phase were to reduce cost, decrease in-process inventory, facilitate continuous flow, and generate more throughput in can-making operations. As a consequence of systematization and increased levels of throughput, the expedited manufacture of cans on an assembly line created specialist firms solely devoted to can making. The de-linking of can making and canning began in the early 1880s.

Integration may have been imagined by can-makers and canners alike, but it burst upon the American canning industry unexpectedly in 1883. An article in the June 1883 issue of *Scientific American*, described a standard "machine-made" can manufacturing process. The first step was the stamping operation where four presses cut strips, formed tops and bottoms, punched a hole in the top, and the last machine made the caps for the can. Nowhere does the article mention the press performing multiple operations in a singular stroke. The next step was formation and soldering of the can cylinders, once completed, "the hollow cylinder is taken off." There is no

mention of can cylinders being automatically conveyed to the next operation. In fact, the article stated "the next workman has before him three piles . . . one is of the body of the can, so called, or the hollow cylinder . . . in the other piles before him respectively are the bottoms and heads from the stamping operation." Apparently, the assembly process as understood by the author of the article, consisted of moving piles of materials from one place in the factory to another. The workman who had "before him three piles," applied rosin as flux and affixed the top and bottom to the "hollow cylinder." The next step was soldering the top and bottom to the can "by the machine that is to do the 'outside soldering' which distinguishes it from the hand-made can." The author described the operation of a floating machine, a machine in his judgment that was "very simple and is run by a boy." The can was rotated "five or six times" in a bath of molten solder with the excess being "scraped off at the same time." The balance of the article described the filling, capping, tipping, and processing operations. It then touched upon quality issues and some of the health concerns with canned foods, the primary one being consumption of solder or the muriatic acid in the flux.⁸³

While the article was a good summary of both machine and hand-made manufacturing practices, correctly noting the major difference between machine and hand-made cans being the method by which ends were soldered to the cans, the authors did not mention several important developments. First, machine-made cans were much less expensive than hand-made cans. They were produced in greater

⁸³ Unattributed, "Tin Cans and Foods," *Scientific American*, Vol. XLVII, No. 22 (June 2, 1883), 341.

quantities in a similar period of time and consumed less material, primarily solder. Second, the article made the assembly and filling or processing operations seem like a seamless process. This was not the case. If a cannery made its own tin cans, most would be made in the off-season, January through May, and filled during pack season, August through November. Third, there was no mention of specialist firms producing cans, and by the early 1880s there were several firms of this nature clustered primarily in Baltimore. Finally, and most importantly for the "integration" phase, the machine-made can assembly process was not characterized by any sort of sequential and linked method of manufacture. Material simply moved from one part of the factory to another with no semblance of continuous flow. There were, in fact, already developments with integrated can manufacturing at work, yet they did not occur on the eastern seaboard, but in Chicago. Within months of the June 1883 article, *Scientific American* would print an article on integrated can assembly, but they were not the first to report it.

Integrated can assembly was first reported and described by the journal *American Machinist* in July 1883. The article, with vivid explanatory diagrams, began with a general statement on the canning industry: "it is well known, that the consumption of canned goods has become well-nigh universal throughout the world, owing to the cheapness with which they can be supplied." *American Machinist* explained that previously most cans had been hand-made and while "various attempts have been made to introduce machinery, but from the fact that no complete system has hitherto been devised, only isolated machines having been used for doing certain

operations in the process, they have met with but little favor." Most interestingly, the article then went on to claim that the Norton Brothers, Edwin and Oliver of Chicago, owners of a can-making firm as well as manufacturers of can-making equipment, "have been laboring persistently," the past five years to perfect such a complete system. The sheets of tin were slit to size, then fed by hand into the body maker, which formed the cylinder by locking or folding the ends of the rectangular body onto one another. The formed, yet unsoldered can cylinders, traveled by "an endless chain carrier" to a side seam soldering station. The exposed seam was oriented by hand, then "soldered at the rate of 50 per minute by a very simple machine." Once the can side seam was soldered, the tin cans continued along the "endless chain carrier" to Norton's Automatic Can Ending Machine, with a capacity of 3,600 per hour (see figures 3.5 and 3.6). The bottoms were fed "into a feed spout" by hand, where they were affixed, overlapping the outside of the can body, by a turret. As the turret revolved, an individual end would be presented and attached to the can body "with the greatest accuracy." The can, with bottom attached, rotated while traveling down a conveyor and moved through a flux, then solder bath at an angle, with excess solder wiped away at various points on the line. Once the bottom was soldered onto the can and the unit left the solder bath, then "one of the most simple and yet interesting appliances in the whole system is brought into use" and the can was flipped one hundred and eighty degrees, so that it was oriented to have the top attached. As the cans traversed the conveyor they were "subjected to cooling blasts," finally cooling enough to have the top attached and

soldered in the same manner as the bottom. Once the ends were attached to the can, every can traveled through a horizontal hot water bath to test for leakage. After the testing, the cans were dried and packaged.

The advantages of the Norton integrated line were many. First, *American Machinist* claimed the cans were more "uniform in quality" and "stronger under all tests" than previous machine-made or hand-made cans. Second, the throughput was exceptional, the first example of "mass production" for tin cans. Each of the machines for attaching and soldering the ends had a capacity of 3,600 cans per hour, but the operation limiting throughput was the side seam soldering at the rate of 3,000 per hour. The system produced 30,000 cans in a ten-hour day. Such speeds had never been reached before leading the *American Machinist* to comment that, "the rapidity with which they can be manufactured is remarkable, thus tending to equalize supply and demand." The article reported that the Pacific Can Company of San Francisco "has been the first to adopt this method of making cans" and the first Norton system had been sent to them. The article concluded that it was the intention "of the inventors and builders of these machines to bring them into general use as rapidly as possible." Norton's line, quite simply, promised to answer the canners' demand for more cans.⁸⁴

⁸⁴ Unattributed, "Norton's Automatic Can Making Machinery," *American Machinist*, Vol. 6, No. 28 (July 14, 1883), 1-2.

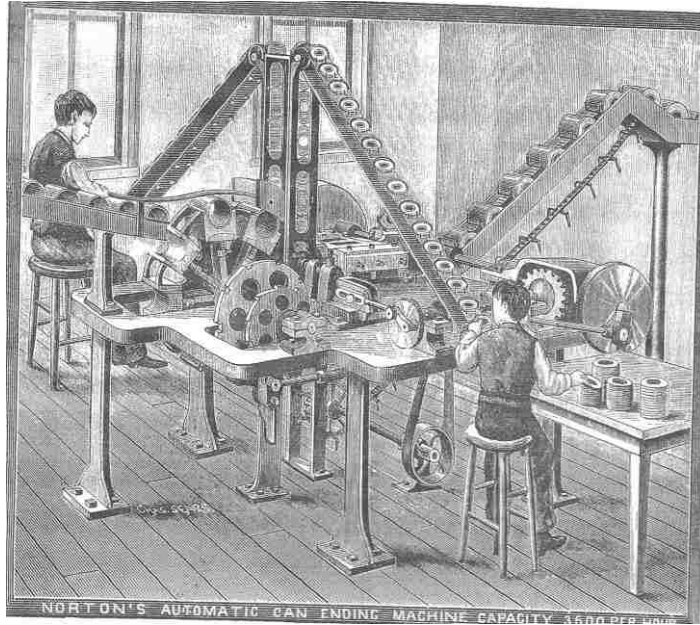

Figure 3.5 - Norton's Automatic Can Line - End Attachment. Taken from *American Machinist*, "Norton's Automatic Can Making Machinery," July 14, 1883.

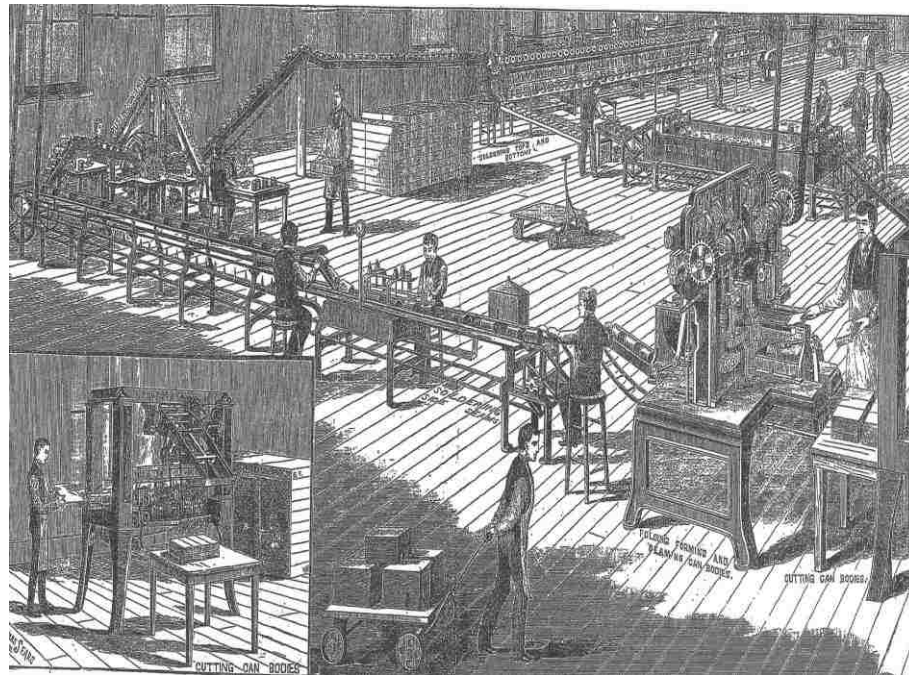

Figure 3.6 - Norton's Automatic Can Line - View of Entire Line. Taken from *American Machinist*, "Norton's Automatic Can Making Machinery," July 14, 1883.

Nearly the same article was published by *Scientific American* a month later, with acknowledgement to the *American Machinist*. The only difference in the *Scientific American* article was the introduction, which was instructive on the current state of the industry, and recognized that the Nortons had deployed a significant invention. The article began with the statement "the growth of the preserved food industry in this country has been so rapid . . . that great difficulty has been experienced by the tin can makers in keeping pace with the demand for their goods." Inventors had been "studying novel forms of machinery to assist the manufacturers in producing the cans," but this was a difficult task because "cans must be not only fitted but soldered by mechanism." *Scientific American* claimed that the Nortons "have at last solved the problem" by manufacturing tin can machinery which was "well nigh perfect in all details of its operation."⁸⁵ The writers at *Scientific American* correctly perceived that expedited can manufacture was a necessary condition for the future growth of commercial canning of food in America. They included very laudatory comments regarding the Nortons, indicating the enthusiastic reception, importance, and significance of their invention. It is somewhat ironic, however, that *Scientific American* had only months earlier been oblivious to developments in can-making and published an article with no mention of continuous flow and integrated can production.

There were other claimants of being the first to integrate can production, but these seem dubious considering the above information from *American Machinist* and

⁸⁵ Unattributed, "Improved Tin Can Machinery," *Scientific American Supplement*, Vol. XVI, No. 398 (August 18, 1883), 6346.

Scientific American. In a 1914 article for the National Cannery Convention in Baltimore, W. H. H. Stevenson, a noted can machinery manufacturer, claimed that the firm of Smith & Wicks of Baltimore was the first to install an integrated, automatic can-making system in 1885. Stevenson argued that Smith & Wicks "were selling as many machine-made cans as they were hand-made" and that their operation had two buildings, "one for machine and the other for hand-made cans." The Smith & Wicks system had "originated" with George Brooks. His brother, William Brooks, had designed such a system for another firm, Black & Krebs. Both the Brooks systems were similar, yet one "soldered on the inside and the other the outside, using a rotary wheel floater and a side seamer."⁸⁶ Likewise, A. J. MacNaughton, the 1930s director of the Tin Research and Development Council, attributed the first integrated and automatic can making line to Smith & Wicks of Baltimore in 1885.⁸⁷ He had used Stevenson's article for his information; therefore, he made no independent confirmation of his findings.

Stevenson's claim of Baltimore being the first location to integrate can-making is inaccurate and incorrect because of his biases. First, since the center of can-making had been Baltimore until the early 1900s, there would be a natural reticence to attribute significant can-making developments in the nineteenth century to locations outside Baltimore. An inventor in Chicago (Norton) and adopter in California (Pacific Can) who together changed the course of technological development by integrating can-making

⁸⁶ W. H. H. Stevenson, "Cans and Can-Making Machinery," in Judge, *A History of the Canning Industry*, 92.

⁸⁷ MacNaughton, *Tin Cans and Tin Plate in the United States*, 85.

was anathema to the Baltimore canning elite. Second, Stevenson was a can machinery inventor, but his record of accomplishment in the industry pales in comparison with what Edwin Norton had achieved by the 1880s. Norton's subsequent patents, and national renown thereafter as a key initial organizer of American Can Company and Continental Can Company, large, multi-functional, national concerns that would dominate can-making in the twentieth century, were unmatched by Stevenson. Finally, nowhere in the literature of can-making is there as detailed a description of an integrated can line as in the Norton articles by *American Machinist* and *Scientific American*. In fact, the drawing of Norton's line in both articles is displayed at the Henry Ford Museum in Dearborn, Michigan as an example of possible inspiration for Ford's assembly lines. It seems Stevenson's claim of George Brooks as the inventor, Smith & Wicks as the adopter, and Baltimore as the location was driven by professional jealousy, or more generously, geographic knowledge limitations.

Norton's line also established the general layout and flow of machines and sequential functions for future can production lines. A 1930s publication by the American Can Company titled *The Canned Food Reference Manual*, described the process of "modern" can fabrication. Bodies were first cut on the slitter, then the corners of the rectangular body clipped or "notched" prior to pre-forming on the body maker. The temporarily seamed cylinders were permanently secured by passing over fluxing rolls and finally a solder bath, which by the 1930s had been incorporated into the body maker, "where revolving rolls apply solder to the outside of the side seam." The

next process was attaching the bottom. By the 1930s, unlike the nineteenth century, the ends were not soldered onto the can and only one end, the bottom, was attached by the can manufacturer. The other end was attached after filling by the canner. The cans had flanges formed on both ends and were attached to the can body by rolling, which was performed by a machine named a double seamer. The speed of the line was 300 cans per minute. After seaming of the bottom, the cans passed along a conveyor to the water tester for a quality check to determine whether there was any leakage, then on to final packaging and shipment.⁸⁸ In all respects, with the exception of differences in subsequent methods for securing ends to the cans without solder, and line speed, Norton's sequence of assembly was the same as used nearly sixty years later.

Many of the technological improvements of the "integration" phase were incremental in nature, but there were several major developments. The cutting of tin plate did not change significantly from the "semi-automatic machinery" phase. The major difference in attaching ends was that the Norton Can Ending Machine combined placement and floating into one operation or station on the line. The continuous rotation and floating of the bottoms and tops in the linear solder bath was really just a larger capacity floater and functionally no different from Howe, Merriam, or Triumph models.

There were, however, three significant areas of mechanical change: body making, pressure testing, and conveying. Although first introduced in 1869, the lock and

⁸⁸ American Can Company, *The Canned Food Reference Manual*, 25-32.

lap type seam for body making became prevalent in the 1880s and dominant by the 1890s. The previous seam, the lap seam, merely overlapped the two edges of the body and springs or a foot treadle held it in place for soldering. The major drawback was that this seam was weak, not resistant to higher pressures, and not amenable to high rates of production. For the lock and lap seam, the corners of the body blank were first notched. This was to provide room for the attachment of the ends and a precursor step in creating the hooks on the edges of the plate. After notching, the length of the seam was bent slightly to create the hooks, the hooks were overlapped, then "bumped" to completely form the lock and lap seam. From 1880 to 1900 turret type body makers became popular and they combined making the lock and lap side seam and soldering it in one machine. Production rates of between 2,500 and 3,000 cans per hour became standard. During the 1890s, the Nortons developed machinery using the lock and lap seam capable of making a can from a single sheet of tin plate and achieve speeds of 6,000 cans per hour.⁸⁹

High pressure water testing of cans had been developed by Dr. William Mann in 1882, but by 1883 Edwin Norton and his employee John Hodgson, designed and patented a high capacity can tester. The Mann tester could test two to four cans at a time, but the Norton and Hodgson invention was continuous and could test 3,000 cans an hour. In their patent application, they claimed that "the object of the invention is to provide an automatic machine for testing cans, to discover if there are any leaks in the

⁸⁹ MacNaughton, *Tin Cans and Tin Plate in the United States*, 85; CMI, *The History of the Metal Can*, 5; Van Vleet, 315.

same." The machine was depicted in Norton's 1883 drawing of his integrated can line. The cans were not subjected to high pressure, as in Mann's invention, but submerged in a hot water bath "of sufficient length, so that each can as it passes through is kept in the water long enough to expand the air therein, and thus cause bubbles of air to escape and arise there from through the water should there be any leaks." The significant features of the automatic tester were a delivery chute to the machine, a horizontal hot water bath, a clamping mechanism and rubbers to seal the cans, an "endless chain" to propel the cans through the hot water bath, a discharge chute, and a final "heating or drying trough or passage" to prevent oxidation of the cans once they were tested. It is significant to note their tester was capable of carrying "two rows of cans, side by side, through the bath." They claimed the combination of "hot water bath or tank," "endless chain carrier," delivery and exit chutes, "the device for closing the openings in the cans," and all the supporting mechanical apparatus of the tester as being part of their invention.⁹⁰ Later versions of in-line testers eliminated the need for water and relied upon low pressure air. They were also placed vertically so as to minimize their floor footprint. Nevertheless, Norton and Hodgson had designed a tester perfectly compatible for an integrated can line.

The final innovative component of Norton's line was not a mechanical device, but the method by which he envisioned can assembly should function, continuous flow. While the body making and testing function required significant invention and

⁹⁰ Edwin Norton and John G. Hodgson. 1883. Can-Testing Machine. U. S. Patent 287,048, filed November 23, 1882, issued October 23, 1883.

modification to be adapted to his vision of an integrated can line, many other of his machines were very similar to existing equipment. What distinguished Norton's line was the linking of individual machines through conveyors, or the "endless chain" referred to in his can tester patent and the *American Machinist* and *Scientific American* articles. Most of the material handling devices on his line were mechanically driven, linear chain conveyors and sprockets, powered by steam engines or coal gas. There were a few inclined conveyors for sections at the end attachment station which were also powered, but use of unpowered "gravity conveyors" were incorporated into sections of the line where the weight of the tin can provided the impetus, such as his entry chutes into the can tester. He used the sections of conveyors between stations to cool cans and also as a buffer between subsequent machining stations, in order to insure continuous, uninterrupted flow of partially assembled cans along the length of his line. The only modern type conveyor which Norton apparently did not use were magnetic conveyors to move cans perpendicular to the factory floor, but his thinking was essentially modern and unconventional for the late nineteenth century.

Norton's Automatic Can Line was targeted for the few large can-makers that existed in the early 1880s. There was still demand from smaller canners for canning lines to equip them for self-manufacture. In their catalogues, the can machinery companies in the 1880s and 1890s offered several complete canning lines. For example, the 1885 catalogue from the Ferracute Machine Company advertised a can-making line, "for the convenience of those about starting in the canning business." The line was

intended "for an Ordinary Can Factory, running 4 or 5 men, and making 1, 2, and 3 lb. Fruit or Vegetable Cans." It consisted of a full complement of can-making machines and tools: presses for making ends and caps, tooling dies, squaring shears, forming rolls, seamer frames and cylinders, can-makers fire pots for soldering irons, floating boards for attaching tops and bottoms, soldering coppers, rosin and wiper boxes, a set of bench tools, and even supplies for making wooden crates. The "outfit" was a combination of hand tools, bench tools, and machines, but assembly by hand. The kit cost \$417 and was capable of making 3,000 cans per day.⁹¹ Six years later in 1891, Ferracute sold the exact same "outfit" for \$400.⁹² Although the price reduction was modest, it reflected an attempt to continue servicing this declining line of business. By the time Ayars Machine Company published their 1900 catalogue, small-scale, self-manufacturing of cans by canners was increasingly less common. A partially mechanized line for manufacture of 3,000 to 4,000 cans per day, including Triumph Floaters which had been on the leading edge of technology a few years earlier, cost only \$225.⁹³

The 1890 E. F. Kirwan catalogue advertisement for self-manufacturing lines stated:

. . . the increasing manufacture by improved machinery and large plants, and the close margin on which they are sold, renders the making of cans by individual packers more a question of convenience than of profit. For the benefit, however, of those who may desire to manufacture their own cans, we give cost of outfit for both hand and machine made cans.

⁹¹ Ferracute Machine Company, *Catalogue "D": Illustrated Catalogue and Price List*, 69.

⁹² Ferracute Machine Company, *Catalogue "E": Revised Price List for Presses, Dies, etc.* (Bridgeton, N.J.: Ferracute Machine Company, 1891), 2.

⁹³ Ayars Machine Company, *Catalogue of Presses, Dies, Can-Making Tools*, 5.

Kirwan offered a high capacity line equipped with modern machinery consisting of a seaming machine, a floating machine, a testing machine, plus an assortment of presses and dies for \$5,750. The capacity of this line was rated between 10,000 and 20,000 cans per day. Their hand-made line cost \$402.50, but could manufacture only 3,000 cans a day.⁹⁴ Kirwan, a large Baltimore firm, readily understood that the industry was in the midst of enormous technological change, and had identified three major trends in the above quote. First, "improved machinery" had caused hand-made cans to become nearly obsolete. It was becoming increasingly too expensive to hand manufacture tin cans. Second, making cans was no longer a value-added, profit generating enterprise for canners. Due to "close margins" it was "more a question of convenience than of profit." Finally, the rise of "large plants" indicated a new phenomenon in the industry -- a separate, specialized industry focused solely on the manufacture of cans.

The birth of a can-making industry separate and distinct from canning and processing the product was the most significant business development stemming from Norton's line. Historian Mark Wilde argued that Edwin Norton "had begun separating the manufacture of cans from the canning process. By the mid-1890s, one equipment supplier noted that packers making their own cans did so for convenience, not profits."⁹⁵ The Can Manufacturers Institute, the lobbying arm of the industry founded in 1938, argued that developments of the 1880s through 1900 "put an end to making cans

⁹⁴ E. F. Kirwan Manufacturing Company, *Catalogue of Cans, Machinery, and general Canning House Supplies*, 90.

⁹⁵ Wilde, "Industrialization of Food Processing in the United States," 35.

in the cannery and marked the beginning of the can manufacturing industry as a separate entity."⁹⁶ Archaeologist James Rock contended that "until the mid-1880s, can-making was a part of the canning business itself and was linked to the processing plant. The demand for tin cans had become sufficiently great by about 1885 that a separate can-producing industry became necessary. Such businesses could focus on the problems of can production . . . without the added responsibility of undertaking successful foodstuff processing."⁹⁷

Before it is recognized and reported by the Bureau of the Census, a new industry is immature and in the formative stages of development. For example, the number of can-making establishments was first reported in the 1904 Census of Manufactures. It was regarded as too small an industry to be included in previous data. There were 377 establishments "making tin pails; buckets; cans; boxes." Excluded from this number were "the manufacture of tin cans and other containers by establishments engaged in canning and preserving." Therefore, the reported figures were for firms who specialized in the manufacture of cans, not canners who still self-manufactured. While the revolutionary technological changes between 1883 and 1904 spawned a new industry, a few canners continued to manufacture their own cans into the twentieth century. The specialist can manufacturers of 1904 employed 16,919 persons and the value of the product was slightly under \$42 million. The "value-added" from the manufacturing

⁹⁶ CMI, *History of the Metal Can*, 5.

⁹⁷ Rock, "Cans in the Countryside," 104-105.

process was 15.6 million dollars.⁹⁸ Can-making was a substantial new development in American industry.

The expense of the new canning machinery and incorporation into a continuous flow production line was initially borne by large manufacturing companies which had the financial resources to absorb the expense and business to leverage the additional capacity. Many of the initial can manufacturing companies were also equipment manufacturers. In addition to building machinery, Norton Brothers also sold finished cans, primarily to customers geographically situated close to Chicago. The E. F. Kirwan Manufacturing Company was one of the larger Baltimore firms to sell both equipment and cans. Their 1890 catalogue stated they had "two of our three large factories devoted entirely to the manufacture of Cans for the canning trade, the one making cans by machinery, the other making hand-made cans and cans of special sizes." They listed five different sizes of cans for sale: #1, #2, #3, #6, and #10. Kirwan advised customers to buy early for "those who may desire to secure the benefit of the low prices usually prevailing during the early part of the year, we will give free storage and insurance until needed, provided cans are settled for." Interestingly, Kirwan recognized many canners still preferred to make some of their own cans "to keep a portion of their capping force employed through the winter," so they sold "Bodies and Trimmings [tops and bottoms] cut ready for making" for those "packers who do not care to invest in the expense of

⁹⁸ U. S. Department of Commerce - Bureau of the Census, *Abstract of the Census of Manufactures 1914* (Washington, D.C.: GPO, 1917), 217, 699.

can-making machinery."⁹⁹ Other Baltimore based firms specializing in can manufacturing were Smith & Wick, Numsen and Sons, and Black and Krebs.¹⁰⁰ There were also can-making companies in Philadelphia, Cox Brothers, as well as in Brooklyn, New York, William Vogel & Brothers. The Pacific Can Company of San Francisco was a can-making specialist. According to the article in *American Machinist*, they were the first firm to install a Norton line. Given the long distances cans would have to travel to arrive in California, it is not surprising to find specialist firms quickly becoming established on the west coast. Clearly, beginning in the mid-1880s, firms specializing in can manufacturing became located in all major geographic markets. Specialization continued through the 1890s and awaited the next major technological development, the sanitary or solder-less can.

Phase 5 - Product Design

The "product design" phase was an example of breakthrough innovation in nineteenth-century can-making. There were other important inventions in the design of the can, such as the tapered can for corned beef, but radical changes to the soldered hole-in-cap can forged a new path of innovation in the industry. Known by several names: "open-top can," "The Ams Can," or most commonly "the sanitary can," this novel invention had its technological roots in an old tinsmiths' technique known as "double seaming." The double seam was a method by which tinsmiths joined two

⁹⁹ E. F. Kirwan, *Catalogue of Cans, Machinery, and General Canning House Supplies*, 5, 9.

¹⁰⁰ Kee, *Saving Our Harvest*, 15-19.

pieces of metal together without the use of solder. Each piece of metal had its edges rolled to form hooks, also referred to as flanges or curls. The hooks of each piece were rolled together forming a seam that consisted of five layers of metal. This method of creating a seam was used on a variety of tinware. In Europe during the late nineteenth century, tinsmiths began double seaming certain food cans, but they were unsuccessful using this method for "processed" foods, or tin cans subjected to hot water and steam pressure.¹⁰¹ The reason for their failure was the lack of a sealant to fill the spaces between the layers of metal in a double seamed can. Under heat or pressure, the product inside the can would leak at the seams. The Europeans tried various types of sealants, such as paper and rubber gaskets, all to no avail. The 1890s state of the industry for double seaming is best summarized by the following description in the Ferracuta Machine Company catalogue of 1891. The firm offered a Bliss Company double seamer run by either hand or power. It was designed "for 'double seaming' the ends of fruit, vegetable, fish, meat, paint and lard pails, etc., etc.; also for various odd cans and buckets, cups, etc.; are now used considerably. They also make a tight seam without solder, for goods which are not 'processed,' and the work can be done very rapidly."¹⁰² The cautionary statement that double seaming was not yet suitable for "processed" food eliminated the vast majority of applications for fruits and vegetables, the bulk of the canning business. The double seam needed to be perfected before

¹⁰¹ George W. Cobb, "The Development of the Sanitary Can," in Judge, *A History of the Canning Industry*, 94.

¹⁰² Ferracuta Machine Company, *Catalogue "E": Revised Price List*, 12.

wider use was possible throughout the canning industry.

The first hurdle was making a double seamed can usable for "processed" or "hermetically" packaged foods. The leakage of the contents at the seam was a vexing technological problem. This challenge baffled can-makers throughout the 1890s, but led to several innovative solutions. Jules Gersant and Archibald Buttifant, both Englishmen, were issued U. S. Patent 583,683 on June 1, 1897 for their invention "Process of Hermetically Sealing Metal Boxes or Cans." There was nothing revolutionary in forming the seam: "the heads and body of the can or box are united by a seaming machine of suitable form, and which will produce a rolled seam of several laps or folds." To solve the leakage problem at the seams, Gersant and Buttifant developed "a circumscribing envelope or casing" which enclosed the ends of the double seam. It was essentially a very tight fitting lid for the top and bottom of the can. There were slits on the lid to release pressure from processing. Pressure released during processing was trapped between the double seamed ends and their "casing" or lid. It functioned as a gasket where the slits in the lid allowed "the inner peripheral wall may be exposed to external air," yet it created "a wall of heat" to form between their lid and the double seam, thereby fusing "the original coating between the confined adjacent faces of the outer folds or laps of said seam."¹⁰³ These two inventors recognized the need for a method of creating a gasket between the layers of double seamed metal, but their

¹⁰³ Jules Gersant and Archibald George Buttifant. 1897. Process of Hermetically Sealing Metal Boxes or Cans. U. S. Patent 583,683, filed May 5, 1896, issued June 1, 1897. Prior to their U. S. Patent they had received patents for this process in eleven European countries, Canada, New Zealand, and four states in Australia.

design never became widely adopted because the gasket was permeable in many instances. It relied upon bonding between the metal layers of the seam, without the use of a specific material for the gasket.

There was a better solution being developed by a consortium of American inventors. The key developments in creating a solder-less can were the invention of a suitable sealing material, repeatable and reliable placement of the sealing compound between the layers of metal, and a machine to rapidly double seam the ends onto the can bodies. There were five individuals involved: Max Ams and his son Charles Ams, Julius Brenzinger, William Bogle, and George W. Cobb. Each played a specific role in the innovation process, yet only through their combined efforts did they successfully pioneer a solder-less can, one which is still recognizable today. Max Ams had immigrated to New York from Germany during the Civil War and opened a business, The Max Ams Company, selling a few canned goods such as apple butter and Russian caviar. Much of his canned caviar was exported, so Ams was well aware of can-making developments in Europe. He became interested in the European double seamed container because his American manufactured cans, using solder for seaming ends, were not selling well in Europe. He decided it was necessary to use double seamed cans for his export business, so he began experimenting with this type can. Max and his son Charles developed a paper gasket which proved insufficient to seal the can, so they looked for another material. There had been some experiments in Europe with a thick rubber gasket inserted between the top and body of the can, but it was quite expensive

and rather cumbersome to handle on a high speed canning line. However, Charles was intrigued about the possibilities of rubber and in 1896 developed a rubber gasket from dissolved rubber in a solution of ammonia and water. He believed his liquid rubber solution, commonly referred to within the industry as "compound," was an adequate sealant for the double seamed can, but he had yet to mechanize the process of applying the compound or develop a high speed method for double seaming the ends. At about the same time, Ams founded another company, the Max Ams Machine Company, to develop machinery for lining and double seaming ends.¹⁰⁴

In 1897, Ams hired engineer Julius Brenzinger to develop machinery for lining ends, drying them, and double seaming the ends onto cans. Brenzinger's employment was extremely fortuitous for his company. Brenzinger rivaled Edwin Norton as one of the most significant can-making innovators of the late nineteenth century. In 1896 he developed a machine, called a liner, for applying the Ams' rubber compound to the inside of the bent edge of an end, an area referred to by can-makers as the "curl." After application of the compound, the ends were dried in a rotary oven. A few years later, he developed a double seamer specifically designed for the Ams rubber lined end.¹⁰⁵ Brenzinger was lauded by a 1915 Max Ams Machine Company publication as a superb innovator "whose genius as a creator of new machinery for the canning industry, has proved to be the greatest boon to the trade, in that it enables the producing of

¹⁰⁴ Cobb, "The Development of the Sanitary Can," in Judge, *A History of the Canning Industry*, 95; Kee, 42.

¹⁰⁵ Cobb, "The Development of the Sanitary Can," in Judge, *A History of the Canning Industry*, 94; Kee, 42.

enormous quantities of food products . . . as a result of these enormous outputs, the price of canned goods has been within the reach of everyone."¹⁰⁶ While Brenzinger was important in the development of the solder-less can, he owed much to the foresight and drive of both Max and Charles Ams. The Max Ams Machine Company began manufacturing the new solder-less can, using hand production methods, calling it the "new seam sanitary can" and later the "Ams Sanitary Can" to distinguish it from the "hole-in-cap" can.¹⁰⁷ The terminology "sanitary can" was used to advertise that there was no solder used either inside or outside the can when attaching the ends, but it was still used outside the can to attach the ends of the body together. However, the Ams Machine Company production was merely experimental; they were not producing the can in large quantities.

The commercialization of the "Ams Sanitary Can" depended upon the efforts of William Bogle and George Cobb. Bogle was a sales agent with offices on Park Place in New York City who possessed intimate knowledge of technological developments within the canning industry. He was a wholesale distributor of canned goods from various canners in New York and Pennsylvania. Bogle knew, by 1897, of the experiments of Max and Charles Ams with their revolutionary can. He convinced another canner, George Cobb of the Cobb Preserving Company in Fairport, New York, to try the new can. Bogle believed the sanitary can was superior to the existing soldered can on the market as it

¹⁰⁶ C. H. Stecker, ed., *The Seal of Safety Year Book*, Volume 2 (Mount Vernon, N.Y.: The Max Ams Machine Company, 1915), 8.

¹⁰⁷ Cobb, "The Development of the Sanitary Can," in Judge, *A History of the Canning Industry*, 95.

was amenable to high-speed production, consumed less solder, and was more appealing to consumers because there was no possibility of solder mingling with food inside the can. Bogle had purchased nearly the entire output of Cobb Preserving, so his leverage was a key factor in getting George Cobb to experiment with the new can. The Cobb Preserving Company spent many frustrating years attempting to pack food using the new can, an episode to be explored in detail in a subsequent chapter, with semi-automatic machines developed by the Max Ams Machine Company. They experienced "fairly successful results" by late 1902 and early 1903, and were finally able to can all their food products using the "Ams Sanitary Can" in late 1903. With Bogle's financial backing and organizational skills, Ams, Bogle, and Cobb combined their interests and formed the Sanitary Can Company in 1904. Known as SCC, this entity existed only a few years before being purchased by the fledgling American Can Company in 1908. ACC, by then the leading manufacturer of cans in America, used their market leverage and applied engineering skills to fully diffuse the sanitary can over the next two decades.¹⁰⁸

The advantages of the sanitary can were many. The Max Ams Machine Company, which focused solely upon machinery design and development after formation of SCC, claimed that there was "not one percent of leakage in the packing of food products" using the Ams sanitary system. A 1915 promotional book said the can used "an odorless, tasteless and pure sealing fluid," the cans were "airtight, without the use of solder or acid," thereby "making the cans cheaper, more attractive in appearance

¹⁰⁸ Ibid., 95-96.

and more durable than any on the market." In addition to the economic and aesthetic benefits of the sanitary can, the publication wished to "call attention to the following advantages" listing fourteen other points. One was variable cost reduction from utilization of less expensive labor -- "skilled workman unnecessary. A girl or boy properly instructed may make and seam cans perfectly." The longevity of the can in storage was beneficial because the "cans will not corrode when finished," and "cans for future use may be made ahead for years." The sanitary can could be made in any size or use any amount of tin coating on the plate. The cans were also more rapidly packed by a canner because they were supplied with one end attached as the other end was double seamed on at the canners factory once filled. This exposed the "entire interior of the can . . . which may be filled more quickly with either solids or fluids, than the old style cans." Terminology such as "old style cans" and "old fashioned holes" was an inducement for customers to become modern, efficient, and leading-edge concerns. According to the Max Ams Machine Company, the sanitary can was "constructed on sound, sanitary principles eliminating all the objectionable features now prevailing in other methods."¹⁰⁹ In summary, if you were a serious canner who desired to run a modern, cost effective, and competitive facility, there was little doubt that the Ams sanitary system was far superior to the "hole-in-cap" can (see figure 3.7).

¹⁰⁹ Stecker, *The Seal of Safety*, 7, 212-213.



Figure 3.7 - Sanitary Can. American Can Company Publication, circa 1930s.

The machinery for making sanitary cans, principally made by two firms; Max Ams Machine Company and the E. W. Bliss Company, were all high-speed and truly the pinnacle of mass production in early twentieth-century can-making. Can manufacturing in the "product design" stage had moved from the semi-automatic machines of the "integration" phase to fully automatic with little factory floor labor. The machinery changes of the "product design" phase focused upon four areas: body makers, flangers, double seamers, and testers. Max Ams Machine Company published two equipment catalogs in 1915. The first, *The Seal of Safety*, was designed to inform readers about developments in the canning industry and display the machines Max Ams had for sale. The catalog was 258 pages in length, but less than fifty pages discussed machinery. The majority of the booklet contained topical articles on a variety of subjects, such as the "Canning Industry in California," "Hawaiian Pineapple Canning," "Legal Matters for Canners," "Official Weights for Canned Foods," "Trade Marks," and a myriad of other topics. It was published for the annual convention of the National Canners Association, which was meeting in Baltimore in 1915. The information in the booklet masked the real intent of the catalog: sell Max Ams canning machinery. The machinery section began by extolling the virtues of the Ams sanitary can. Of the twenty-five pieces of equipment offered by Max Ams, twelve were double seamers for their sanitary can, by far the primary focus of the company. A few double seamers were advertised in hand feed or semi-automatic mode, but the majority were automatic machines with no requirement for manual labor in the seaming operation. There were automatic

machines for any type can: fruit or vegetable, round cans for paint, square cans, and oval tins for seafood. The highest speed automatic machine offered was the Ams No. 498 Double Seamer with a capacity of 120 cans per minute (see figure 3.8). The cans

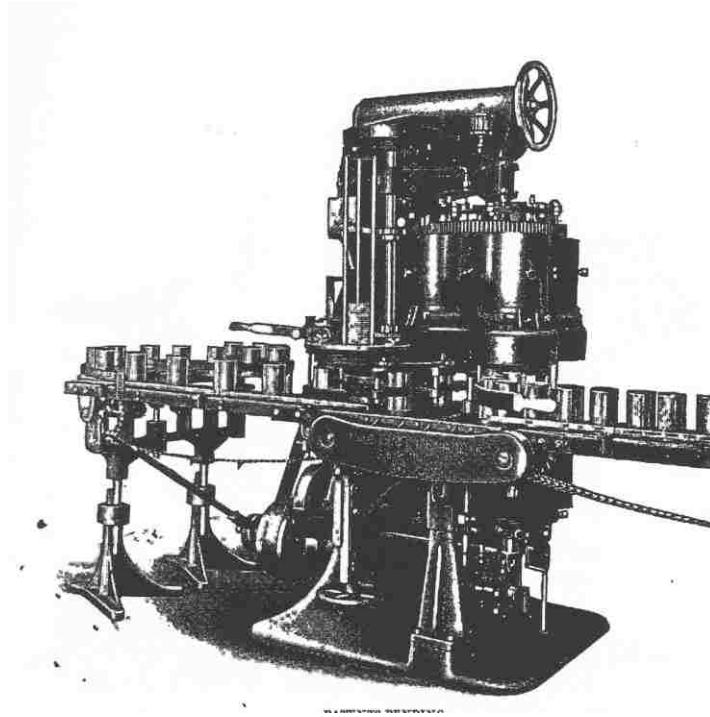

Figure 3.8 - Max Ams No. 498 Double Seamer. Max Ams Machine Company, *Catalogue No. 17 - Panama Exposition, 3.*

were fed into the seamer by a chain conveyor, and Max Ams claimed it would "give entire satisfaction to every canner" and that "no failure has yet been recorded against this seaming ring [machine]."¹¹⁰ The catalog also presented other pieces of equipment, such as lining machines for the rubber sealant applied to ends, flangers for making

¹¹⁰ Ibid., 219-220.

hooks on bodies of cans prior to seaming, and two different types of body makers. In the catalogue the only major piece of missing equipment to complete a can-making line was an air tester. The automatic flanger, Ams No. 93 Automatic Flanger, was capable of 120 cans per minute, while the Ams No. 88A Automatic Can Body Maker, made 75 to 125 cans per minute, depending upon the size.¹¹¹ The company had matched the speeds of equipment throughout the line; capacity, using automatic equipment, was 7,200 cans per hour.

The second Max Ams catalog from 1915, only seventeen pages in length, was a much less ambitious work than *The Seal of Safety*. It was printed for distribution at the 1915 Panama Exposition in San Francisco. This pamphlet was devoid of the informational articles and just advertised the machinery manufactured by the company. However, it was certainly a promotional piece as the cover had an oversized illustration of an "Ams Sanitary Can" with the exposition center in the background (see figure 3.9). The intent was for the reader to immediately associate the new sanitary can with the Max Ams Machine Company and their equipment. The introduction to the pamphlet stated that the company was "ready to supply complete can making equipments from the Punch to the Can Tester." Because Max Ams was a leader in the field of can-making machinery, they claimed that "all of our machines are positively modern in every detail" and that "there is no argument so convincing as the fact that hundreds of satisfied

¹¹¹ Ibid., 239-243.

customers prefer our machines, which letters of testimonial substantiate."¹¹² There were seventeen machines listed in the pamphlet, nine of which were for various types of double seamers, reflecting Ams' specialization in this piece of equipment. The equipment descriptions were brief compared to *The Seal of Safety*, but most of the

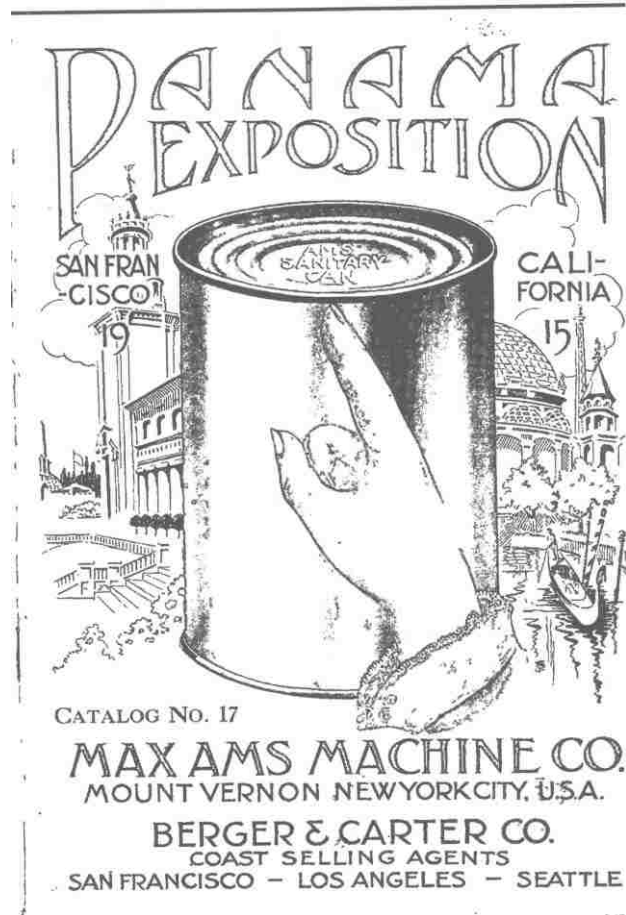

Figure 3.9 - Cover of Max Ams "Panama Exposition" Catalogue. Max Ams Machine Company, *Catalogue No. 17 - Panama Exposition*, cover.

advertised machines were the same. One notable addition to the *Panama Exposition* catalog was the inclusion of the Ams No. 27 Automatic Can Tester. The tester was

¹¹² Max Ams Machine Company, *Catalog No. 17 Max Ams Machine Company - Panama Exposition, San Francisco, California, 1915* (Mount Vernon, N.Y.: Max Ams Machine Company, 1915), introduction.

promoted as being "of great advantage in economizing floor space" measuring 6 feet long, 4 feet wide and 6 feet high. It was outfitted with two rows of twenty-six pockets, vertically arranged on each side, and cans were fed and discharged automatically via conveyors. The tester revolved "in continuous motion at low speed," and any leaking cans were discharged through a chute at the bottom of the machine. The capacity was rated at 120 cans per minute, so it matched the speeds of other Ams machinery such as flangers, double seamers, and body makers.¹¹³

A major competitor of the Max Ams Machine Company was a larger company, the E. W. Bliss Company of Brooklyn, New York. Bliss never claimed to invent the sanitary can, so their catalogs did not contain the promotional verbiage regarding modernity found in the Max Ams publications. Bliss manufactured a wider range of can-making equipment than Ams, including a full line of automatic machines. The 1914 Bliss catalog presented over sixty pieces of equipment, twice the number of machines offered by Ams. The Bliss specialties were punch presses, body makers, double seamers, and air testers. Bliss made fifteen different types of automatic body makers for nearly any type of tin can on the market - sanitary, soldered, round, square, oblong, and oval. Bliss recognized that the increased use of sanitary cans and the speeds at which they could be manufactured required a faster body maker so they developed a machine that was "unquestionably the fastest and best ever offered for this work." Their primary machine for making sanitary food cans was the Bliss Automatic Lock and

¹¹³ Ibid., 14.

Lap Seam Body Maker No. 22N with a capacity of 125 cans a minute "or more under good working conditions."¹¹⁴ Bliss was not committed to just the sanitary can, so the section for seaming ends onto cans included both floaters and double seamers. They offered five automatic double seaming machines. Two of these machines were designed for seaming ends onto filled cans at a canning factory, while the other three were for can-making. The speeds of the machines, however, were slower than those of Max Ams only seaming 75 to 100 cans per minute.¹¹⁵ Finally, the Bliss testers were different from those offered by Max Ams. Two testers had a horizontally, and somewhat angled, circular or round revolving wheel for a tester, while the other was a long linear tester of 12 feet in length. All three models tested 120 cans per minute, so a can-maker's floor space requirements dictated his choice of air tester.¹¹⁶ Both companies had achieved line speeds of 120 cans per minute or 7,200 cans an hour by the mid-1910s, even though the Ams double seamers were slightly faster. Most significantly, both firms had a full line of automatic machinery requiring little, if any, manual labor. The ease of seaming the sanitary can and elimination of soldering ends to cans enabled development of machines which took advantage of the new package and maximized throughput for can-makers. The can-making factory had, thus, become fully mechanized and a model of mass production during the "product design" phase of technological development.

¹¹⁴ E. W. Bliss Company, *Automatic Can-Making Machinery, Section 18* (Brooklyn, N.Y.: E. W. Bliss Company, 1914), 653-654.

¹¹⁵ *Ibid.*, 676-679

¹¹⁶ *Ibid.*, 683-685.

Acceptance and diffusion of the sanitary can was rapid when compared to other can-making innovations. The combined efforts of Max and Charles Ams, Julius Brenzinger, George Cobb, and William Bogle shortened the development process from the concept of a solder-less can to commercialization of a mass produced product in less than seven years. It was a radical departure from past methods of can manufacturing, requiring innovative technical solutions to create a breakthrough technology. The can

Chart 3.1 - Technology Effect Over Time

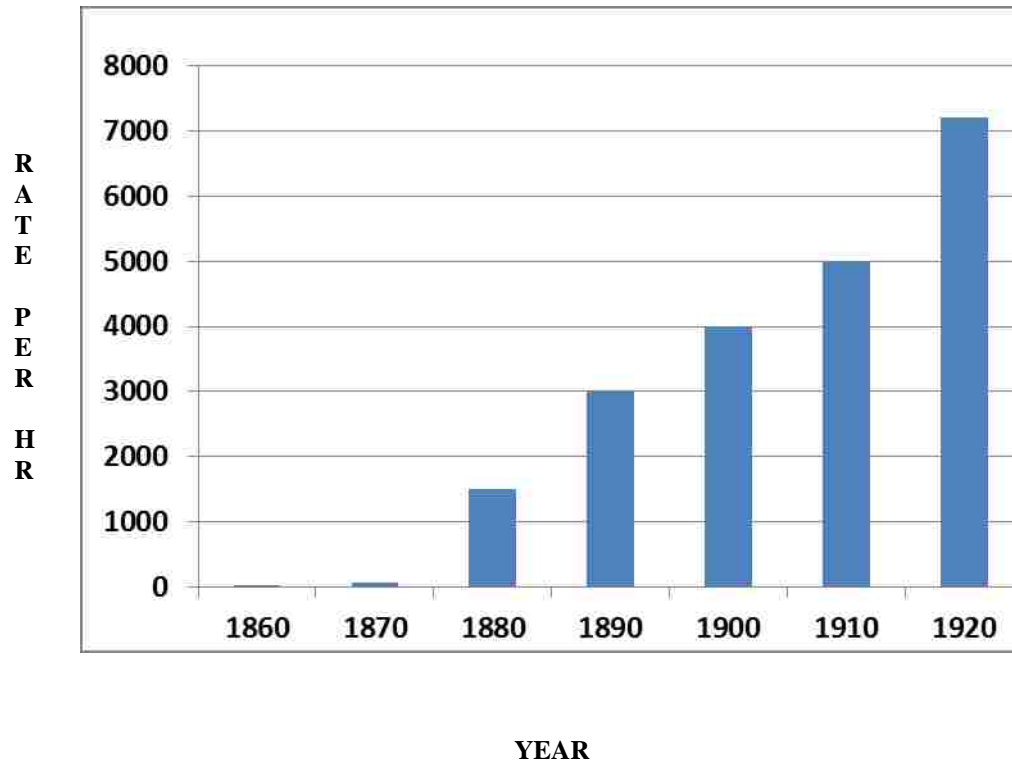

was first adopted by small canners known to Bogle, but quickly spread to larger customers when SCC was purchased by ACC in 1908. The marketing power of this corporate behemoth quickly made the hole-in-cap can obsolete. By the early 1920s, the

sanitary can, also known as the "open-top," or "packers" can, was nearly universally used throughout the canning industry, with the exception of condensed milk.¹¹⁷ The can gained immediate acceptance in the burgeoning fruit canning industry of California and was dominant by 1911.¹¹⁸ The reason was that fruit could now be packed whole or in larger pieces which was impossible with the hole-in-cap can. When ACC placed its marketing and manufacturing prowess behind the sanitary can, more conversions soon followed in the 1910s. The major food packers, such as Campbell's Soup, Heinz, Libby's, and Franco-American Soups, began either manufacturing their own sanitary cans or purchasing them from specialized can manufacturers. The sanitary can suited the manufacturing practices of these large firms -- large volume, demand for few unique sizes, and the need for rapid filling. The desire for the sanitary can "was almost universal" by the late 1910s, a period only fifteen years removed from when George Cobb began experimental canning using the open-top in Fairport, New York.¹¹⁹ The rapid diffusion of the sanitary can is best described by Herbert Baker, a sales manager and future president of ACC, in a 1923 address to the New York Wholesale Grocers' Association. Baker stated that the sanitary can's "adaptability to high-speed automatic handling, together with other advantages, forced its adoption in a most rapid manner. The sanitary or open-top can has reached a stage of development where everyone using and handling it can accord it the greatest respect and confidence as a safe and

¹¹⁷ CMI, *The History of the Metal Can*, 5-6; Clark, *The Tin Can Book*, 18.

¹¹⁸ Rock, "Cans in the Countryside," 107.

¹¹⁹ Hampe and Wittenberg, *The Lifeline of America*, 120.

dependable food container."¹²⁰

One of the "other advantages" alluded to by Baker was the cost of the sanitary can. The can was sold by the can manufacturer with one end attached; the other end would be seamed onto the can once it was filled. The can manufacturer shipped whatever quantity of sanitary cans the customer ordered and a corresponding number of ends for use at the canners' factory. The absence of solder for attaching the ends greatly reduced the material cost of the can. Additionally, a canner could reduce the size of his labor force as the capping and tipping operations on the filling line were completely eliminated by the sanitary can. While a canner would have had to lease or purchase a double seamer for a few hundred dollars, this outlay was a pittance compared to his savings in eliminated labor. Lower material costs combined with ease and rapidity of filling made the sanitary can a bargain for canners. The H. S. Mill Canning Company, a small regional canner in northern Bucks County, Pennsylvania, ordered a portion of their 1908 requirements from SCC requesting 245,000 sanitary cans of various sizes and linings. The major component of the order was 100,000 #2 plain sanitary cans at \$15.75 per thousand or 1.575 cents per can. The price for a #2.5 plain can was \$20.25 per thousand or 2.025 cents a can, while #3 plain was \$21 per thousand or 2.1 cents a can. Cans enameled on the interior, to prevent discoloration of the

¹²⁰ Herbert A. Baker, "Status of the Tin Can in the Canned Foods Industry," An Address Given in New York City to the New York Wholesale Grocers' Association on February 13, 1923 (NY: American Can Company, 1923), 10-11.

contents, were slightly more expensive than plain cans.¹²¹ H. S. Mill was a small, regional canner, so prices for larger firms that demanded more volume were likely somewhat lower. By the first decade of the twentieth century, the cost of a tin can was now measured in pennies, a profound departure from the past.

Conclusion

Technological innovation was one of several historical forces that popularized the tin can and made it ubiquitous in American life by the early twentieth century. The initial military use of tin cans, particularly during the Civil War, introduced many Americans to the new food packaging technology. However, only through technological innovation and mechanization did the tin can become inexpensive enough for canned foods to appeal to a broad cross section of Americans and not remain the exclusive purview of the wealthy. There were five phases of technological development from the mid-nineteenth century through the early 1920s. The technology of can-making progressed from hand-made, craft manufacturing performed by tinsmiths, through proto-mechanization with simple bench or rudimentary devices to aid the craftsman, prior to the Civil War. After the War, semi-automatic machinery was slowly introduced to the process and by the 1880s, individual machines were linked and integrated into a can production line. In the late nineteenth century, the existing product design was seen as a constraint on future growth of the industry, so a group of innovators designed

¹²¹ H. S. Mill Canning Company, "H. S. Mill Canning Company Letterbook, 1905-1908," (Hagley Museum and Library, Manuscripts and Archives Section - Soda House, Greenville, Del.), Accession Number 2497, letter 495.

a new can and machinery to expedite manufacture. This new machinery was fully automatic.

Chart 3.2 - Technology Effect on Can Output by Key Operation

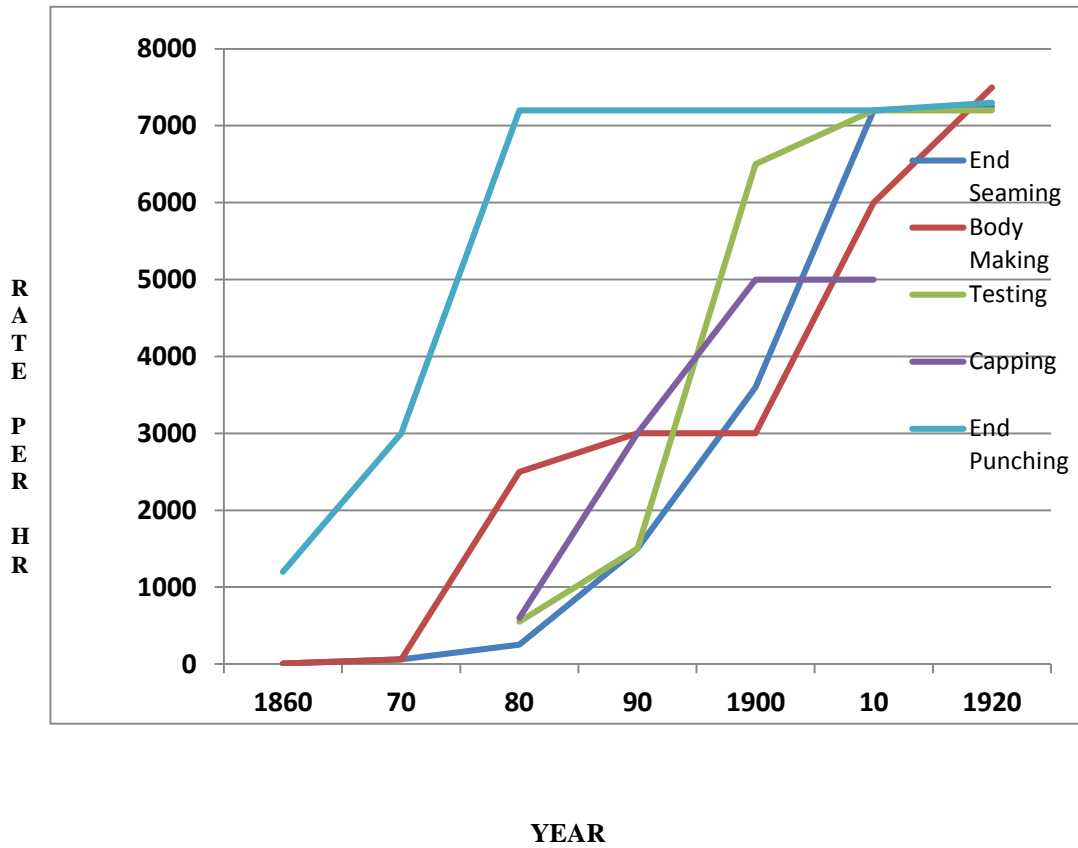

The process limitations at the juncture of each stage spawned inventive energy. The time consuming task of cutting bodies and ends was first addressed by innovators in the late 1840s with the development of platform shears for the bodies and punch presses for the ends. When the supply of component materials was no longer a constraint, inventors directed their energy to accelerated methods for attachment of ends to the cans and formation of the side seam on the can body. The result was a

plethora of simple bench tools that increased the productivity of the can-maker. Beginning in the early 1870s, these bench devices were superseded by the first generation of semi-automatic machines. Again, innovation was directed at attaching ends to cans and making the can cylinder. These two steps of the manufacturing process remained the critical focus of technological innovation throughout the remainder of the nineteenth century. In the 1880s, the throughput of can production increased not necessarily through innovative machinery, but from reorganizing the sequence and flow of materials through the factory by linking and integrating various machines into a system. By the early 1890s, can-making had reached another plateau and further productivity increases were only possible from a reevaluation of the limitations on the existing design of the can. The result of this inquiry was the sanitary can, which essentially attached ends to cans in a substantially different manner than the hole-in-cap can. The design of the can facilitated automatic machinery by eliminating the necessity of soldering ends to cans. By the early twentieth century, can manufacturing had entered the era of mass production.

The process of technological innovation in can-making had several characteristics. First, the early stages of technological development were dominated by incremental improvement to existing machines or devices. The pattern of incremental improvements is readily demonstrated in the progression of designs for nearly every piece of equipment used in can-making and canning, as seen in patent applications and trade catalogues. Incremental improvement was normally accomplished by

independent inventors, such as Edwin Norton, Oberlin Smith, Dr. William Mann, Henry Evans, William Numsen, John A. Wilson, and Andrew Shriver. Each one of these important independent inventors improved upon existing design limitations of equipment already in use throughout the industry and made a significant contribution with their respective inventions. Second, maximizing the productivity gains from single machines required linking them into an interdependent system of manufacture, rather than sub-optimization of individual stations of manufacture. This was accomplished by Edwin Norton in 1883 creating the conditions for the emergence of a can manufacturing industry. The productive capability of improved machinery, when coupled with a system of manufacture, exceeded the seasonal requirements of most canners. As a result, a separate can-making industry arose. Finally, breakthrough innovation in can-making occurred in the late nineteenth century. The invention of the sanitary can was achieved through the combined efforts and interdependent interests of Max and Charles Ams, Julius Brenzinger, George Cobb, and William Bogle. Each person brought distinct talents to the process: visionary conception of the goal, chemistry or mechanical skill, production expertise, and the business skills of raising capital and commercialization of a new idea. The efforts of these five individuals was a group endeavor, yet they were independent inventors and their innovation was not the product of early twentieth-century corporate research and development. Their breakthrough innovation changed the future path of the can-making industry and facilitated the true mass production of tin cans using fully automatic machinery.

The diffusion of new technology throughout the can-making industry was anything but a tidal wave sweeping along everything and everyone in its path. There were a multitude of reasons why a canner or can-maker would adopt new technology: to increase throughput, reduce costs, shrink the labor content of his costs through deskilling, improve quality, or avoid strikes or work stoppages. However, the pace of adaptation varied in accordance with the specific, local business challenges faced by the canner. Factors such as the availability of a local labor supply, complexity of his can requirements, capital funding limitations, the quantity of cans required, locations of canning plants, and the local competitive landscape often dictated whether, and to what degree, mechanization was embraced. Many firms lingered at an earlier phase of technological development if capital was constrained, there was little regional competition, and local labor was abundant. On the other hand, leading-edge firms tended to be large, well capitalized, operated in a competitive environment, or were managed by forward-thinking, visionary leaders. The leading-edge canning firms tended to adopt individual machines, pursue integration, or purchase their cans from a specialist firm, before the smaller, more locally oriented businesses. The largest of food canners, such as Libby's, Heinz, Borden's, and Franco-American fit the conditions for self-manufacture -- capital availability, volume, uncomplicated product mix -- and subsequently built internal, technologically modern can-making facilities. The additional benefits included the ability to control their supply chain and the convenience of self-

manufacture. Even some of these firms slowly migrated to can-making specialists, but not until the early twentieth century.

Chart 3.3 - Technology Effect by Phase of Technological Development

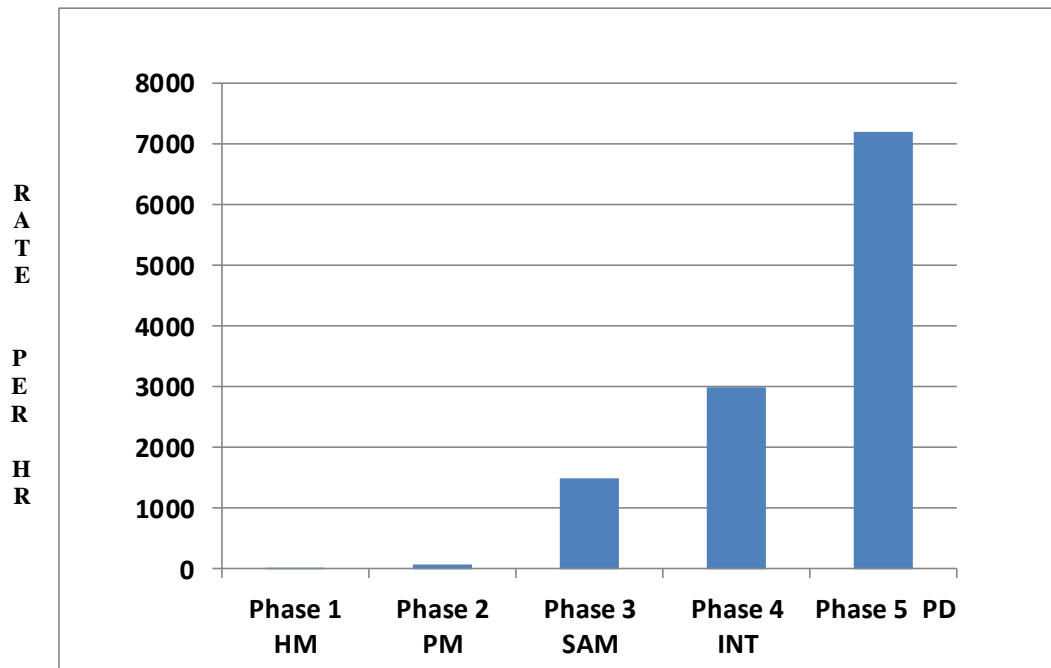

The increase in rates of production or throughput was nothing short of astounding as the industry progressed through successive phases of technological development. In the "craft" phase, 5 or 6 cans were made by tinsmiths in an hour for a daily rate, using the then standard ten-hour day, of 60 cans per day. After a few simple devices were introduced in the "proto-mechanization" phase, production rates were 60 cans per hour or 600 in a day of work. Can production rates demonstrated a significant leap forward during the "semi-automatic" phase of development when machinery was first introduced to can-making. The rates were highly dependent upon the type

equipment employed by a can-maker, such as the type of floater, but rates of 1,500 per day were standard by 1880 and 2,500 per day by 1890. Rates of between 5,000 and 7,000 cans per day were possible if several similar machines were used in conjunction with one another. During the "integration" phase of development, equipment modifications and sequencing individual special purpose machines into a can-making assembly line allowed throughput to take a major bound forward. The Norton integrated can assembly line advertised rates of 3,000 cans an hour or 30,000 in a day. Finally, the reorientation away from the hole-in-cap can to the sanitary can in the "product design" phase produced a considerable increase in throughput. By the mid-1910s, can lines making sanitary cans and equipped with either Max Ams or Bliss machinery were capable of making 7,200 cans an hour or 72,000 a day. The sanitary can eliminated the need for the slow process of soldering ends to cans, reduced manufacturing costs, and was tailored for mass production. The pace of throughput and reduced costs, coupled with the marketing prowess of American Can Company, converted nearly the entire can-making industry to the sanitary can within the span of two decades. In roughly sixty years, can-making had progressed from craft-based manufacturing practices making 60 cans per day, to mass production and unheard of rates of 72,000 a day.

The increased rates of production dramatically reduced the price canners paid for their cans. There exists a strong correlation between increased rates of production and decreased costs for cans. Cost data for manufacturers is often very difficult to

uncover because it was held then, as now, in close confidence as it was critical competitive information. We do know that the Pennsylvania tinsmith Samuel Harrison Bingman sold craft-made tin cans for twenty-nine cents each in 1850. By 1875, can-makers in Baltimore were paid sixty cents per hundred, yet were charged for defective work. An advertisement from J. W. Jones for attracting can-makers stated "Can Makers to be charged for imperfect work at the rate of . . . 96 cts per doz. for Corn [#2] and other sizes." The advertisement declared "one months [sic] pay to be kept back to cover imperfect work," yet the company would provide many can-making tools and pre-cut components.¹²² J. W. Jones appeared to be somewhere between the "proto-mechanization" and "semi-automatic" phases of technological development. The charge of 96 cents per dozen cans for imperfect work translated to 8 cents per can, which is likely the actual manufacturing cost of the can. Assuming a can was sold for a modest profit, can prices in the mid-1870s were 8 to 10 cents a can. During the next twenty years, progression through the "semi-automatic" and "integration" phases decreased prices for tin cans even further. In 1899 a canner in New York State, the Wayne County Preserving Company, paid 1.8 cents each for #2 cans. In an August 1899 letter from E. K. Burnham of the Wayne County Preserving Company to the R. Tynes & Smith Can Company of Baltimore, Burnham wrote "Gentlemen, we will accept your offer to furnish us 200,000 #2 cans at \$18 per M . . . provided you can ship in large cars

¹²² American Can Company, *The Canned Food Reference Manual*, 16.

holding 100,000 cans."¹²³ The Tynes & Smith Can Company, a specialist firm, produced large quantities of hole-in-cap cans, and most likely used the modern semi-automatic equipment arranged in some type of assembly line. Finally, a little over eight years later, the H. S. Mill Canning Company of Springtown, Pennsylvania paid 1.575 cents each for 100,000 #2 sanitary cans from the Sanitary Can Company. The actual cost of a tin can had declined from 29 cents in 1850 to 1.575 cents each by 1908. The actual decrease in can costs, without consideration of fluctuations in the value of money over time, significantly reduced the cost of canned foods, thereby stimulating demand.

W. H. H. Stevenson, a noted can machinery maker of the early twentieth century, said the following in 1914:

The development of automatic can-making machinery constitutes one of the wonders of the canning industry. . . . In the short space of one century, there was originated a new receptacle, which was to make possible the revolution of our food supply, and the means for rapidly manufacturing it. There is possibly no single line of American manufacture to equal this development from a pair of tinner's shears and stake to the complete automatic can line, which takes in a sheet of shining tin at one end and turns out at the other a finished, tested and counted can at a rate as high as 65,000 perfected cans per day. Little wonder that even experienced canners stand in amazement at the sight of this smoothly running, automatic workman.¹²⁴

Making allowances for Mr. Stevenson's hyperbole and promotional tone, his acknowledgement of the role played by technological innovation to increase the

¹²³ Edgett-Burnham Company Records, 1854-1930, "Production Records and Accounts, 1855-1879," (Division of Rare and Manuscript Collections, Carl A. Kroch Library, Cornell University, Ithaca, New York, Archive Number 2522), Box 1, "Letterbook 1885," 866.

¹²⁴ W. H. H. Stevenson, "Cans and Can-Making Machinery," in Judge, *A History of the Canning Industry*, 93.

quantity of cans produced, thereby reducing their cost, is accurate. The rapid progress of can making technology is attributable to the creative and inventive genius of many individuals. There were other components to the acceptance of the tin can and further democratization of food, however, technological development and innovation were paramount.

Chapter 4 - Case Studies in Can Manufacturing

*Just a scrub with soap and water,
Takes away the silt and mold,
A container and a label,
And it's ready to be sold;
The floods of nineteen thirty-seven
Threw terror into man,
Yet couldn't harm the contents
Of that little old tin can.*

Winthrop C. Adams, 1937¹

The last stanza from Winthrop Adams' poem *The Little Old Tin Can* is an homage to the survivability of tin cans during the Ohio River floods of 1937. The “old tin can” would strike a chord with nearly everyone, as canned food had become common and adopted throughout the country. The poem signaled the omnipresence of tin cans in American society by the 1930s. The can had become a metaphor for human resilience and ingenuity in the aftermath of disaster. Quite appropriately, how the tin can became ingrained in American culture also required human ingenuity, persistence, resilience, and determination -- the same skills required to recover from a natural disaster. Adams was mistaken, however, when he assumed the similarity of tin cans and human reaction to misfortune. Just as human reactions to adversity differ, so did the acceptance of technology for manufacturing the tin can. There were inherent differences in tin cans and the varied suppliers and processors within the canned food industry.

This chapter demonstrates, through case studies, the varied and differential pace of technological diffusion of tin cans. The process of technological diffusion was not

¹ Earl C. May, *The Canning Clan*, 455.

uniform in can-making and canning. The deployment of technology throughout the industry was not monolithic and depended upon specific business conditions confronting each participant. While diffusion of technology and the market force of a distinct can-making industry consummated in rapid industrial change in the early twentieth century, there were still many small canners. This chapter expands upon many of the themes from the preceding chapter on technology and the tin can. It investigates the day-to-day operations of canners, as well as providing a snapshot of life as a late nineteenth-century can-maker and early twentieth-century business owner. The case studies explore the entire supply chain before and after canning, to include sourcing of raw materials and the retail promotion of the finished product. It offers a comprehensive framework of how the industry operated and reveals the ebb and flow of the annual business cycle.

There were three individuals who played critical roles in the development of can-making technology: Edwin Norton, George Cobb, and William Bogle. Edwin Norton, discussed in the previous chapter, was the inventor of the integrated can manufacturing line, a noted can-maker, and mechanical genius with many can-making patents to his credit. George Cobb commercialized the revolutionary sanitary can in the early twentieth century, and resolved many product design issues through years of trial-and-error experimentation. William Bogle operated in many realms of canning and can-making. He was at times a promoter of the tin can, financial backer of canning operations, confidant and consultant for canners, and a sales agent for canned food.

Bogle was removed from the day-to-day operations of a cannery or can-making facility, so he held a wider perspective of industry developments. In contemporary terms, Bogle was a "visionary." The impact of these three men upon the can-making industry, and the roles they performed in technological diffusion, are investigated in this chapter.

The case studies represent a cross section of can-making and canning operations between the 1870s and the 1910s. They will chiefly focus upon four small firms, which taken as a whole, are representative of the varied pace of technological diffusion within can-making. These firms represent vastly different sizes and approaches to technological change. The first firm, the Wayne County Preserving Company (WCPC), located in upstate New York, began operations in the 1860s as the Edgett-Burnham Company which supplied canned goods for the Federal forces during the Civil War. WCPC was a large regional firm and operated in the 1870s and 1880s by making its own cans. It adopted certain pieces of can-making machinery in the nineteenth century, but eventually began purchasing larger quantities of cans from specialist can companies. The second company, the H. S. Mill Canning Company (HSM), located in Springtown, Pennsylvania, was a small, regional canning company, selling most of their products within a one hundred mile radius of their factory. It purchased nearly all its can requirements from specialist can companies and had limited technological expertise within its operation. The third firm, the Cobb Preserving Company (CPC) of Fairport, New York, was also a regional canner. This firm, discussed in the previous chapter, was a can-maker, canner, and the field development site for the sanitary can. Oral history

interviews from many former CPC employees lend insight into the life of a nineteenth-century can-maker, as well as the trial-and-error process surrounding the development of the new style sanitary can. The final firm, Norton Brothers, was a specialist can-making company. The Norton brothers, Oliver and Edwin, focused solely upon manufacturing cans and machinery for can-making. They were initially located slightly west of the Chicago River in downtown Chicago, but relocated to the suburb of Maywood, Illinois in the 1880s. Their Maywood facility initially encompassed two buildings, but grew to include nine buildings, a completely vertically integrated can-making enterprise, and was the largest can-making plant in American in the mid-1890s. These four case studies include three canners who at various times made their own cans, but eventually purchased their cans from specialty can companies, and a dedicated can-making specialist. Taken as a group, these firms are fairly representative of the differential pace of technological diffusion within the can-making industry.

Large food marketers also existed in the time period under investigation. For a basis of comparison with the smaller firms, this chapter makes general observations on how larger, vertically integrated firms, functioned. These firms generally offered branded products to a broad national market. Most, but not all of these operations, were also self-manufacturers. Their operations were characterized by large quantity packing of a relatively limited number of can sizes. Due to their large volume, these firms could afford to purchase machinery and raw materials, such as steel and solder, in bulk, thereby experiencing economies of scale. The firms are Heinz, Borden's Milk,

Campbell Soup, Franco-American Soups, and Dole Pineapple. These firms played a minor role in developing can-making technology, but a major role in popularizing canned foods.

Landscape of the Industry

One reason for the differential pace of technological diffusion was the rapid expansion of the canning industry during the late nineteenth century. Statistics on canning and preserving were first reported in the 1870 Census. The number of canning establishments packing fruits and vegetables was 97. These factories employed 5,869 people, and the total value of the product was 5.4 million dollars. During the remainder of the nineteenth century, the number of canning plants grew to 411 in 1880, 886 in 1890, and 1,808 by 1900. The number of employees and value of the product also increased considerably in these thirty years to 38,142 employees in 1900, with the value of the product estimated at 56.7 million dollars.² By 1914, there were 3,153 establishments canning fruits and vegetables, employing 58,329 people, and generating value added of over 149 million dollars.³ By any measure, the growth of canning was phenomenal in the late nineteenth and early twentieth centuries. In thirty years the industry increased from 97 to 1,808 establishments, a nearly nineteen fold increase. The number of employees swelled seven times the 1870 number for a gain of over 32,000 more employees. The value of the canned product grew over one thousand

² United States Department of the Interior, Census Office, *Twelfth Census of the United States Taken in the Year 1900*, Volume IX, Manufactures, Part III, Special Reports on Selected Industries (Washington, D.C.: GPO, 1902), 467.

³ United States Department of Commerce, *Census of Manufactures 1914*, Volume II, 365.

percent with a net increase of over 50 million dollars. While the statistics demonstrate growth of over 700 percent in terms of employees and 1,000 percent for value added, the number of establishments increased much faster at nearly 1,900 percent. These data indicate that many small firms entered the industry in the late nineteenth century. With many small, likely undercapitalized, firms entering the market, it is understandable that the pace of technological diffusion would vary substantially throughout the industry.

The locus of canning also changed considerably in the late nineteenth century. The geographic shift of the industry from east to west created conditions unsuitable for the uniform diffusion of technology. The traditional roots of the industry were on the east coast and centered in Baltimore. However, by 1900, California had surpassed Maryland as the largest canner of fruits and vegetables. This shift was primarily attributable to the growth of fruit packing, especially peaches, in California. The 1900 pack of peaches for the entire United States was valued at 4.4 million dollars, and 3.1 million, or 70.4 percent, was canned in California. Maryland remained a significant center for canning and was still the largest packer of tomatoes. The 1900 value of all tomatoes packed in the United States was 13.9 million, and 3.9 million, or 28.1 percent were still canned in Maryland.⁴ The following table (see Table 4.1) lists the top five canning states over the period 1870 to 1900 and the percent of American volume that they packed. The significant number of "others" by 1880 indicates how widely dispersed

⁴ United States Department of the Interior, Census Office, *Twelfth Census*, Volume IX, Manufactures, Part III, 474-5, 478.

the industry had become. The industry began the late nineteenth century centered on the east coast without much canning outside this region. By 1900 there was a significant amount of canning on the west coast for fruit and the Midwest for corn. Given the widely dispersed nature of canning and can-making, it is little wonder that the pace of technological diffusion varied considerably throughout the industry.

Table 4.1 - Top Fruit and Vegetable Canning States (% Packed)

Rank	1870	1880	1890	1900
1	Maryland (29.6)	Maryland (35.2)	Maryland (24.1)	California (23.1)
2	New York (20.4)	New York (13.6)	California (20.7)	Maryland (21.2)
3	New Jersey (16.1)	New Jersey (8.1)	New York (9.7)	New York (15.9)
4	Maine (11.5)	Maine (8)	New Jersey (6)	Illinois (6.5)
5	Pennsylvania (9.3)	California (7.9)	Virginia (4.7)	Indiana (4.6)
Others	(13.1)	(27.2)	(34.8)	(28.7)

Source: Data for 1880 taken from United States Department of the Interior, Census Office, *Report on the Manufacturer of the United States at the Tenth Census, June 1, 1880*, Volume II (Washington, D. C.: GPO, 1883, 40: data for 1870 taken from United States Department of the Interior, *Ninth Census*, Volume III, 436; data for 1890 and 1900 from United States Department of the Interior, Census Office, *Twelfth Census*, Volume IX, Manufactures, Part III, 469-471.

The size of fruit and vegetable canning firms also varied considerably, which was another factor impeding uniform diffusion of new technology. As the industry grew and became more geographically dispersed in the late nineteenth century, there were many smaller entrants in the market. Yet the relative size of firms differed considerably amongst regions. For example, there were 135 canning establishments in California by 1900. Sixty firms employed fifty persons or less, while the balance, seventy-five

factories, employed over fifty-one workers. The mix was then 44 percent small plants and 56 percent medium or large factories. In Maryland by 1900, there were 271 canning establishments. Even though California was the largest canning state by value of product packed, Maryland had twice the number of plants. Thus, the relative size of a plant in Maryland was much smaller than California. Maryland had 154 plants which employed fifty or fewer workers, for a total of 57 percent small plants. The balance of 117 plants, 43 percent, were medium or large facilities. In the largest plants, those employing five hundred or more workers, there were eighteen in California, compared to six in Maryland.⁵ The size of firm and the region in which it was located were factors influencing diffusion of technology. Cannery in California were somewhat isolated from those on the east coast. As a result, the decision whether to make or buy their cans, mechanize their can-making, and purchase the most modern canning equipment differed from region to region.

The *Twelfth Census* also included a thirty-page summary on the current state of the canning industry, along with analysis of the data and industry trends. The section was written by Arthur L. Hunt, a former California canner, who was hired by the Department of the Interior to write this monograph. He was a person with intimate knowledge of the canning industry. Hunt began his article, "Canning and Preserving, Fruits, Vegetables, Fish, and Oysters," by acknowledging the accomplishments of the industry. He stated that canning "is an industry which has grown to be an important

⁵ Ibid., 472.

factor in the commercial and industrial development of the United States." He continued, "it [the canning industry] has long since passed the experimental stage and has taken its place among the leading industries of the country."⁶ Much of his article is a history of the development of the industry, both can-making and canning, and analysis of products packed by region or state. Regarding the rise of the can-making industry, Hunt stated that "can making is now a distinct industry, and not usually carried on, as formerly, in connection with the actual canning of the foods. It is estimated, however, that about 10 percent of the cans are still made by the canning establishments. For the past fifteen years labor-saving machines have been introduced in can manufacture until now all the parts are made and put together by mechanical devices."⁷ Hunt wrote in 1902 before the sanitary can, but he certainly recognized that by the first decade of the twentieth century, most can-making was performed by specialist firms and accomplished with the aid of machines. It was in the first decade of the twentieth century that can-making by canners was no longer a profitable venture, as the first case study illustrates.

Wayne County Preserving Company

The Wayne County Preserving Company was a large regional cannery located in Newark, New York. It was situated on the Erie Canal, approximately 35 miles southeast of Rochester, and slightly north of the Finger Lakes Region. The origins of the firm dated to 1854 when it began operations as the Edgett & Totten Company in Camden, New

⁶ Ibid., 463.

⁷ Ibid., 464.

York. The firm began operations as a local dry goods merchant, but switched to canning around the time of the Civil War. In 1863, one of the owners, Ezra Edgett, purchased his partner's interest in the company, renamed it the Wayne County Preserving Company (WCPC), and relocated to Newark. Throughout the Civil War, Edgett & Totten, then the recently formed WCPC, provided canned foods for use by the Union Army. Business was robust and the company had a sterling reputation, so in 1865 a larger cannery was built in Newark. This cannery served as the principle factory for WCPC, but it opened a satellite operation in the 1870s in Buffalo, New York, naming it the Erie Preserving Company.⁸ The company manufactured its own cans for most of the nineteenth century and concentrated on canning fruits and vegetables. Items packed included corn, tomatoes, rhubarb, string beans, cherries, strawberries, raspberries, plums, peaches, pears, and apples. In 1889, Ezra Edgett passed away, and a local attorney, Edwin K. Burnham, joined the firm and assisted Edgett's widow in running the company. The firm reincorporated as the Edgett-Burnham Company in 1908 when Burnham's son joined the enterprise. The Edgett-Burnham Company continued operations until the 1960s, primarily as a packer under contract to large supermarkets. It closed down to avoid mandatory New York State capital expenditures to pre-treat waste water dumped into the Erie Canal.⁹

The Wayne County Preserving Company grew substantially in the late nineteenth

⁸ Edgett-Burnham Company Records, 1854-1930, "Production Records and Accounts 1855-1869" (Division of Rare and Manuscript Collections, Carl A. Kroch Library, Cornell University, Ithaca, New York, Archive #2522), Box 45, "E. A. Edgett Old Book 1854-1873." Hereafter cited as EBC.

⁹ <http://www.waynecountylife.com/2009/06/edgett-burnham-canning-company.html>, (accessed October 2, 2014).

century. It was a small local canner in the 1870s, hand-manufacturing 259,085 cans in 1877, 282,533 cans in 1878, and 321,892 in 1879.¹⁰ By the late nineteenth century and early twentieth century, WCPC had grown to become a large regional firm. Annual can production was 1.839 million in 1900, 2 million in 1901, and 2.286 million in 1902. These were all self-manufactured, hole-in-cap cans.¹¹ The expansion of the firm in a period of twenty years required changes in both business management practices and procedures for the manufacture of tin cans. WCPC's experience reveals insights into business practices and daily operations of a late nineteenth-century canner and the effects of early twentieth-century legislation, such as the 1906 Pure Food Act. It also demonstrates several of the phases of technological adaptation in the late nineteenth century, as well as important business decisions on adopting the sanitary can, and switching from self-manufacture to purchasing cans from a specialist can-making company. In summary, the operations of WCPC are representative of the myriad large regional canners functioning in the late nineteenth and early twentieth centuries. How and why WCPC made the decisions it did reveals the particulars of slow-paced diffusion, typical of can-making and canning technology in this time period.

There was a defined rhythm in the annual cycle of a nineteenth-century cannery. The calendar year was divided into two seasons: packing and preparation. The packing season began when the first crops of the season were harvested, normally in the late

¹⁰ EBC, "Production Records and Accounts, 1870-1879," Archive #2522, Box 46, "E. A. Edgett 1877 Can Book," 369-376.

¹¹ EBC, "Production Records and Accounts, 1900-1902," Archive #2522, Box 50, "Ledger 1901/1902," 77, 232, 235.

spring. The beginning and end of the packing season varied according to climate, geography, and latitude. In New York State the packing season began in June and lasted until sometime in November. The first crops harvested were berries, while the last were pumpkins, squash, and other early autumn vegetables. The height of the season was between these two periods when canners focused on packing their mainstay crops: corn, tomatoes, beans, and various fruits. Once the packing season ended, preparation for the next season began. While the pace of work was somewhat less hectic then, it was no less important. During the preparation season, canners would focus on selling any remaining inventory packed that season, perform maintenance on key equipment, and begin to build their can supply either through contracts or self-manufacture.

Obtaining raw material, vegetables, fruits, and berries was the first order of business during the packing season. For example, Ezra Edgett purchased strawberries from several local farmers in July 1875. The vendors were primarily women, Sarah Ryckman, Emma Petty, and Mary Blum and the quantities were limited -- only a few quarts each. These small quantities were combined, then canned. For their time consuming effort picking the strawberries, these women were paid two cents per quart.¹² In August 1877, Edgett purchased twenty-one bushels of plums from J. D. Whipple, a local farmer, for \$42, and another four bushels of plums at \$9, so these latter ones must have been higher grade or larger plums. He also purchased thirteen bushels of Bartlett Pears from Whipple with prices ranging from \$4 to \$4.50 per bushel. His

¹² EBC, "Production Records and Accounts, 1870-1879," Archive #2522, Box 46, "Ledger," 46.

"Corn and Fruit Book" for 1877, in which he recorded the prices he paid for various items, also indicates many large purchases of corn and tomatoes.¹³ Edgett's recordkeeping was meticulous and provided him accurate cost data for his raw materials.

Ezra Edgett had a unique method for managing his cannery. Every season, he developed notebooks for nearly every aspect of his operation. For example, in 1878 he had notebooks, by specific crop, in which he recorded the quantities packed every day. Occasional notes were made by him concerning quality variations within the product category. There were separate account books for fruit, corn, tomatoes, berries, and rhubarb. In each book, he listed bulk and small purchases, complete with the date, quantity of produce, company or vendor, price per unit of measure, and the total cost. He also had ledgers, for example, entitled "Labor and Time Book 1878" in which he recorded total hours worked, by employee, their rate of daily pay, and total pay for the week. For example, the week of September 2, 1878, there were 63 employees working at the Newark cannery. They were in the midst of the packing season and were very busy. Rates of pay varied by position, but ten-hour days, six days a week was standard for this time of year. The rate of pay for a non-skilled worker was fifty cents per day, or five cents an hour. Edgett also had a "Ledger" in which daily cash debits or credits were recorded, as well as account books for "Shipping," a "Daybook" for general notes, and a "Can Book" in which he listed the quantities of cans produced, by can-maker, for each

¹³ EBC, "Production Records and Accounts, 1854-1869," Archive #2522, Box 45, "Corn and Fruit Book 1877."

day they were employed making cans. It was a sophisticated recordkeeping system and one that provided him the information needed to run his cannery.¹⁴

Once the produce was processed, the canner had to sell it. There were two methods employed by nineteenth-century canners: retail sales to local merchants and marketing goods more widely through a sales agent or broker. The Wayne County Preserving Company employed both sales channels. Direct retail sales were normally within the local geographic area and rarely extended beyond fifty miles from the point of canning. This was an economic limit as the quantities sold to local vendors were generally small, and both parties desired to minimize shipping costs. To retailer A. Elbridge & Company of Bronx, New York, on August 12, 1867 he sold strawberries, pears, and tomatoes at 28 cents, 33 cents, and 17 cents per can, respectively. These prices were certainly lower than those of the recently concluded Civil War. These goods were likely sold without a sales agent. The same account entry showed Edgett selling pears to H. Woodruff of Camden, New York for 25 cents a can.¹⁵ The eight cent difference in price for a can of pears reflected lower transportation costs to Camden versus Bronx, a cost in this instance borne by the seller. Small quantity sales remained a mainstay of WCPC in the 1870s and 1880s. In 1876, WCPC sold 261 #2 cans of corn to Mr. H. Foster of Newark, New York for 15 cents a can and in 1877 sold 72 #2 cans of

¹⁴ EBC, "Production Records and Accounts, 1870-1879," Archive #2522, Box 46.

¹⁵ EBC, "Production Records and Accounts, 1854-1869," Archive #2522, Box 45, "Camden Bank Account Book."

corn to Dave Salmon & Company of Syracuse, New York at 14.5 cents a can.¹⁶ In the 1870s, the prevailing rate for #2 cans of corn was 15 cents, the same size can of peaches averaged 25 cents a can, while tomatoes were slightly less than corn at 13 cents a can.¹⁷ The quantities sold through the local distribution channels varied from a few cans to several dozen. In the 1880s, larger sizes of cans were selling for even less, yet the quantities sold remained small. On November 7, 1881, Edgett sold corn, tomatoes, peaches, and pears to E. E. Davidson, a local general merchandiser. The quantities were very small: four dozen cans of both corn and tomatoes, and three dozen cans of peaches, and three dozen cans of pears. The prices were 11 cents for a #2.5 can of corn, 10 cents for a #3 can of tomatoes, 23 cents for a #3 can of peaches, and 40 cents for a #2.5 can of pears.¹⁸ Clearly, prices were declining for canned goods, even for the relatively small quantities required by local customers.

Local retail sales remained a component of WCPC's business into the twentieth century. In 1904, a local grocer from Baldwinsville, New York, P. H. Steele, inquired about the availability of canned goods. Since it was the end of the packing season, inventory was limited, and E. K. Burnham replied "we have nothing to offer except our high grade goods." Included in his price list were "2# [sic] Fancy Corn at \$1.25/dz, 3# [sic] Fancy Tomatoes at \$1.25/dz, and 2# [sic] Fancy String Beans at \$1.35/dz."¹⁹ Even

¹⁶ EBC, "Production Records and Accounts, 1854-1869," Archive #2522, Box 45, "Daybook Journal," 4, 140.

¹⁷ Ibid., 4, 6, 21, 140, 282.

¹⁸ EBC, "Production Records and Accounts, 1870-1879," Archive #2522, Box 46, "Prices."

¹⁹ WCPC to P. H. Steele, Baldwinsville, N.Y., November 26, 1904, EBC, "Letterbooks 1885 -," Archive #2522, Box 1, "Letterbook, 11/23/04 - 2/22/06," 5.

though these were the finest goods canned by WCPC, the prices were 10 cents a can for corn and tomatoes, and 11 cents for string beans. At these prices, even the best canned goods were becoming increasingly accessible to more Americans.

Ezra Edgett was also a local broker for small canners in the area around Newark, New York. However, he must have had a very limited line of business as there were very few instances in his correspondence of him acting in the capacity of food broker. He received a letter on February 7, 1875, from Mr. H. M. Shepard of Fairport, New York listing canned goods he had available for sale. The items included 20 cases (480 cans) of #2.5 Large Blue Plums and 4 cases #2.5 Large Purple Plums. The price was \$3 per dozen cans, and according to Shepard "they are fine and ought to bring at least \$3.00 a doz [sic]." Shepard also had 9 cases of #2 Egg Plums, at \$2.25 a dozen, as well as white cherries, dark cherries, and pears available for sale.²⁰

Sales through a broker were normally much larger and the main avenue through which canners distributed their product. The considerable output of WCPC required the services of an agent, in this case Bogle & Lyles of New York City, who had access to markets beyond the northwest region of New York State. On July 15, 1879, WCPC shipped to Bogle & Lyles, via railroad, 20 cases, or 480 cans of white cherries and 10 cases, 240 cans, of strawberries. There must have been a significant demand for these products as shipment using the railroad was more expensive than a barge on the Erie

²⁰ H. M. Shepard, Fairport, N.Y. to E. A. Edgett, Newark, N.Y., February, 7, 1875, EBC, "Production Records and Accounts, 1870-1879," Archive #2522, Box 46, "E. A. Edgett Day Book for 1875."

Canal. Later that month on July 28th, WCPC shipped 755 cases of cherries and 100 cases of strawberries, or 20,520 cans, to Bogle & Lyles from their cannery in Buffalo via "boat." A further 1,153 cases, or 27,672 cans, of cherries, raspberries, and strawberries were shipped from the primary cannery in Newark, New York to Bogle & Lyles on the same date. WCPC shipped, in the month of July 1879 alone, nearly 50,000 cans of fruit via the Erie Canal.²¹ Broker shipments were much larger than those to local retailers, and because of the large quantities shipped, minimizing transportation costs was important. Recognizing that Bogle & Lyles were prominent sales agents, WCPC desired to advertise their mutual relationship to give their firm an aura of respectability. The name "Bogle and Lyles, Sales Agents with offices at 87 & 89 Park Place, New York City" was printed on virtually all WCPC business correspondence in the 1880s.²² The business connection with William Bogle continued into the twentieth century when the sanitary can was adopted by WCPC.

During the preparation or off-season portion of a canner's business cycle, equipment was purchased and repairs made to machinery. E. K. Burnham maintained a lively correspondence with many of the major canning machinery companies. Most of the canning processing equipment was purchased through Ayars Machine Company of Salem, New Jersey. In August 1898 WCPC was considering the purchase of another tomato filler, but delayed the investment when they informed Ayars "we have given up the idea of buying a tomato filler this year, that is an extra one . . . another year we may

²¹ EBC, "Production Records and Accounts, 1870-1879," Archive #2522, Box 46, "Shipping Book."

²² EBC, "Production Records and Accounts, 1854-1869," Archive #2522, Box 45.

want another, may want to increase capacity."²³ In addition to the tomato fillers, pea blanching baskets were also purchased from Ayars. They shipped equipment to the Sprague Canning Machine Company of Hoopeston, Illinois for overhaul, as well as purchased replacement parts for their Hawkins Cappers from Sprague. In January 1905 WCPC requested Sprague to overhaul another Capper. WCPC stated "We like our Hawkins Capping machines very much, and we have had some very satisfactory work from them, and it always annoys us when they are not in condition to do themselves justice."²⁴ Sprague was also used during emergency situations that occurred during the packing season. In August 1901, during the height of the packing season, WCPC requested an expedited shipment of replacement parts for their Hawkins Capper, "please ship us express two clamps for steels in Hawkins Capper. Also ship the two hangers for shaft that runs the long carrier on the Hawkins."²⁵ WCPC also made their own tin cans for a period of time and employed both Triumph and Lewis floaters for attaching ends to cans. In May 1903, they requested "7 spools Wire Solder on Triumph spools" for use with their machines.²⁶ The company had a history of using many types of floaters and seamers, but by the early twentieth century it exclusively employed Lewis floaters and Phelps seamers. In a letter to a potential buyer for some of their can-

²³ WCPC to Ayars Machine Company, Salem, New Jersey, August 15, 1898, EBC, "Letterbooks 1885 -," Archive #2522, Box 1, "Letterbook, 8/11/98 - 10/10/99," 10.

²⁴ WCPC to Sprague Canning Machine Company, Chicago, Illinois, January 16, 1905, EBC, "Letterbooks 1885 -," Archive #2522, Box 1, "Letterbook, 11/23/04 - 2/22/06," 97.

²⁵ WCPC to Sprague Manufacturing Company, Hoopeston, Illinois, August 13, 1901, EBC, "Letterbooks 1885 -," Archive #2522, Box 1, "Letterbook, 8/9/01 - 7/16/02," 12.

²⁶ WCPC to Rochester Lead Works, Rochester, New York, May 18, 1903, EBC, "Letterbooks 1885 -," Archive #2522, Box 1, "Letterbook, 5/3/03 - 2/25/04," 65.

making equipment, William Miller, the factory superintendent for WCPC, stated that "for the last four years the Lewis floaters which float five cans at a time . . . have provided excellent results." He explained further that "we use two of these [Lewis floaters] in connection with our Phelps seamer, one for floating tops and one for floating bottoms."²⁷ Selling excess equipment during the off-season was yet another task performed by employees of a cannery.

Unquestionably, the most important activity of the preparation season was to obtain a secure can supply for the subsequent packing season. If a canner self-manufactured their cans, the off-season was when most cans were made. F. E. Flynn, who began working at WCPC at age twelve in 1889 pulling peas off vines and preparing them for processing, noted that cans "were made in the winter when there was not much else going on."²⁸ Likewise, another can-maker and cannery employee, George J. Olney, who began working in his father's cannery in the early twentieth century, stated unequivocally that the first operation in any cannery was getting prepared for the packing season: "Of course the first operation would be to have the items ready to pack corn. That meant cans. In those days you had to make your own cans, which was quite an undertaking and somewhat primitive."²⁹ WCPC began operations in the late 1860s and early 1870s by hand-manufacturing cans using craft-based procedures. At this

²⁷ Mr. W. M. Miller of WCPC to Mr. H. I. Matthews, Lakeport, Ontario, Canada, December 6, 1905, EBC, "Letterbooks 1885 -," Archive #2522, Box 1, "Letterbook, 11/23/04 - 2/22/064," 861-862.

²⁸ "F. E. Flynn Oral History Manuscript," interview by Edward F. Keuchel, 10 March, 1964, New York State Food Processing Industry Oral History Project, Division of Rare and Manuscript Collections, Carl A. Kroch Library, Cornell University, Ithaca, New York, Archive # 2378, Transcript # 1225, 1-7.

²⁹ "George J. Olney Oral History Manuscript," interview by Edward F. Keuchel, 12 July, 1963, New York State Food Processing Industry Oral History Project, Archive #2378, Transcript #1206, 1-2.

point, they were squarely in phase one of technological development.

By the late 1870s, WCPC had advanced to the "proto-mechanization" phase of technological development, as evidenced by rates of production. According to Ezra Edgett's "Can Book for 1877" the firm employed seven can-makers: James Curtis, Andrew Palms, Frank Bills, Daniel Bills, Thomas Flynn, William Flynn, and William Miller. Each can-maker's daily output was recorded for every month. The best can-makers were paid on a piece-rate system: thirty-five cents per 100 cans and slightly more, seventy-five cents per 100, when making gallons -- a more time consuming task. For example, Edgett's best can-maker, Andrew Palms, made 11,400 "corn cans" in May 1877 in twenty-two ten-hour days for a rate of 52 cans per hour. The best can-makers, Curtis and Palms, were also paid for "housework" at the rate of forty cents a day when not making cans in the slack period of January through April.³⁰ Overall, the firm made 259,095 cans in 1877, 282,533 in 1878, and 321,892 in 1879. The most common size was #2, in quantities of 79,730, 194,230, and 178,950, respectively, for the years 1877 to 1879.³¹ There may have been adoption of some other bench devices by 1882, as Palms made cans at the rate of production between 59 to 63 per hour, or 594 to 625 per day.³² These rates were only somewhat higher than what he was making five years earlier. The firm was growing, but seemed constrained by limited can supply.

WCPC progressed through the first three phases of can-making technological

³⁰ EBC, "Production Records and Accounts, 1870-1879," Archive #2522, Box 46, "Can Book for 1877," 4-20.

³¹ Ibid., 366-375.

³² EBC, "Production Records and Accounts, 1870-1879," Archive #2522, Box 46, "E. A. Edgett Ledger 9/12/1882 - 7/6/1883."

development in a period of roughly ten years. It began by hand manufacturing cans in the late 1860s, and by the late 1870s and early 1880s they employed bench making apparatus. In the middle to late 1880s, a change in their can-making procedures occurred, and the firm entered the "semi-automatic mechanization" phase of technological development. The growing firm employed 117 workers by September 1883, versus 63 just five years earlier.³³ They had adopted some form of mechanization in the mid-1880s, as evidenced by rates of production and new pay rates for can-makers. In early June 1886, the firm had already made 247,900 #2 cans and had steel on hand to make another 169,000. They were on pace to make nearly 400,000 #2 cans in 1886, or double the annual production between 1877 and 1880. They made over 30,000 cans in twelve days between May 26th and June 8th for a rate of over 2,500 per day -- quite an increase from merely a few years earlier. WCPC now employed only six can-makers. In the month of February 1886, Curtis and Flynn made 22,150 and 20,300 cans, respectively. They were now averaging between 1,000 and 1,500 cans a day, or more than double what they had been making five years earlier. The rates of daily production were now reported in either of these round numbers, rather than by counting individual cans. The evidence does not answer whether production quantities were rounded up or down no matter the specific number of cans produced or if the machine was stopped at a certain point. More importantly, the rates of production and the manner in which they were measured both suggest the use of some type of semi-

³³ Ibid.

automatic machinery. Additionally, the rate of pay had decreased and was now ten cents per 100 cans versus thirty five cents per 100 in 1877.³⁴ A can-maker who made 500 cans a day during the "proto-mechanization" phase was paid \$1.75 for his labor, while by the mid-1880s in the "semi-automatic" phase he earned \$1.50 for making 1,500 cans in a day of labor. James Curtis made 42,300 #2 cans in March 1886 when he worked twenty-four days, or 1,760 cans a day, and was paid \$42.30 for the month. Likewise, Thomas Flynn made 25,000 #2 cans in March and 18,300 in April, for which he was paid \$25 and \$18.30, respectively. The increased rate of production was a function of mechanization, while the decreased rate of pay an example of paying lower labor costs through the use of mechanization. WCPC adopted mechanized can-making machinery to both increase output and reduce labor costs.

While the Wayne County Preserving Company began operations by self-manufacturing all their own requirements for cans, this proved inadequate to meet the demands of their growing business even with semi-automatic mechanization. As a result, in the 1890s, they began to supplement self-manufacture by having some of their can requirements met by specialist can companies. They still made some of their own cans, as evidenced by orders for tin plate. In August 1898 they had to "borrow" tin plate from another can company "to keep us going until this tin gets here."³⁵ However, they were also buying cans. A letter to the R. Tynes, Smith Can Company of Baltimore in

³⁴ EBC, "Production Records and Accounts, 1880-1889," Archive #2522, Box 47, "Can Book 1886 & 1887."

³⁵ WCPC to C. S. Trench & Co., New York City, August 17, 1898, EBC, "Letterbooks, 1885 -," Archive #2522, Box 1, "Letterbook 8/11/98 - 10/10/99," 18.

September 1898 instructed them to "Ship at once one car of our cans. Wire answer."³⁶

They continued to conduct business with this Baltimore can company and in 1899 agreed to a longer term supply contract. E. K. Burnham sent an order to R. Tynes stating "Gentlemen, we accept your offer to furnish us 200,000 2# [sic] cans . . . provided you can ship in large cars [railroad] holding 100,000. They must be Baltimore cans." The price was 1.8 cents for a #2 can.³⁷ Burnham's admonishment to ship in large cars was to reduce freight expense and his stipulation that they be "Baltimore cans," recognition this city was known to provide a good product.

WCPC's outside orders to specialist can companies continued to grow in the first decade of the twentieth century. Not only were the number of orders and quantities increasing, the cost per can was decreasing. In August 1901, WCPC placed an order with C. H. Smith Company of Newark, New York for 60,000 #3 cans at 2.8 cents a can.³⁸ In May 1903, they placed an order with the E. F. Smith Company of Baltimore for cans and they offered "\$20.00 per M [thousand] for the car of 3# cans, delivered Newark . . . for the later part of June."³⁹ The price for a #3 can from a can company now was two cents a can, or nearly a 30 percent decrease in the span of two years. In 1905, WCPC placed one of its largest orders with a specialist can company. In November 1904, E. K.

³⁶ WCPC to R. Tynes, Smith Can Company, Baltimore, Maryland, September 10, 1898, EBC, "Letterbooks, 1885 -," Archive #2522, Box 1, "Letterbook 8/11/98 - 10/10/99," 85.

³⁷ Ibid., 866.

³⁸ EBC, "Letterbooks, 1885 -," Archive #2522, Box 1, "Letterbook 8/9/01 - 7/16/02," 26.

³⁹ EBC, "Letterbooks, 1885 -," Archive #2522, Box 1, "Letterbook 5/3/03 - 2/25/04," 44. The 2 cent price for a #3 can suggests that the can cost was 15 - 20 percent of the retail price for a can of goods selling between 10 and 12 cents, which was common for the first decade of the twentieth century. There was an inverse relationship between the percentage of can cost for an inexpensive retail product, such as corn, and an expensive item such as high-grade fruit. The more expensive the product packed by the canner, the less expensive the can as a percent of total cost, and vice versa for inexpensive products.

Burnham agreed to an annual supply contract with the New Hartford Canning Company of New Hartford, New York stating, "you may enter our order for 600,000 two pound cans, 1-1/2 opening, for delivery at our option during June and July . . . this order being based upon your giving us an option on 400,000 more two pound cans . . . quality of cans to be equal to, or better, than those furnished us this season."⁴⁰ This single order with New Hartford was for one million cans or roughly 50 percent of the total can requirements for WCPC.

The Wayne County Preserving Company adopted the sanitary can within a few years of its introduction. The process began as a limited trial with a few orders of gallon cans, a difficult item to manufacture due to its size. Initial correspondence between WCPC and the Sanitary Can Company (SCC) began in January 1905. SCC made a proposition to manufacture a limited number of cans, 12,000 gallon or #10 cans. WCPC's response was "should we find the Can entirely satisfactory, we will be very glad to give you the information [specific order quantities] at the earliest possible moment."⁴¹ Correspondence between the two companies for the next three months concerned the logistics of obtaining the tinfoil and finalizing the contract. The initial order of gallon cans was shipped in May, and with it a double seamer for affixing the top to the can. In a letter from late April, Burnham instructed SCC to "ship the car of gallons any time after May 1st via West Shore R. R. We suppose you will include the Double

⁴⁰ WCPC to S. F. Sherman, Utica, New York - Treasurer of New Hartford Canning Company, New Hartford, New York, November 26, 1904, EBC, "Letterbooks, 1885 -," Archive #2522, Box 1, "Letterbook 11/23/04 - 2/22/06," 3.

⁴¹ WCPC to SCC, Fairport, New York, January 25, 1905, EBC, "Letterbooks, 1885 -," Archive #2522, Box 1, "Letterbook 11/23/04 - 2/22/06," 119.

Seamer in the shipment."⁴² In early May 1905, before even running the gallon cans, WCPC inquired on whether SCC made a #3 can. They did, but the height of the SCC can was slightly taller than the WCPC self-manufactured version. Nevertheless, SCC made the changes to their can. Shortly thereafter, WCPC requested samples of #2 and #2.5 cans. SCC sent a representative to WCPC to instruct their mechanics on how to operate the double seamer. Soon, WCPC requested "plates and other apparatus necessary for changing to different size cans."⁴³ The WCPC made requests and plans to conduct trial runs on different sizes of the sanitary can, even before they ran the initial shipment of gallon cans. They were certainly eager to migrate to the new style can.

The initial run of gallon cans was made on May 29, 1905, and WCPC was very pleased with the results. According to E. K. Burnham, "we packed about 60 cans of gallon Rhubarb on Saturday, in the Sanitary Can, and got along with the seaming very nicely." For the next run, WCPC requested a representative from SCC when they packed a "larger quantity." On the same day, in another letter, Burnham inquired on coated or interior lined cans. He stated "we understand you have a coated Sanitary Can, and we would be pleased to have your quotation on this style package." The sizes were #2, #2.5, and #3. According to Burnham, "we will want to use some of these coated cans, possibly, on the different fruits."⁴⁴ There were a few minor quality issues, but these were resolved immediately. For example, in June SCC was concerned that WCPC might

⁴² Ibid., 272.

⁴³ Ibid., 299, 306, 307, 314, 341.

⁴⁴ WCPC to SCC, Fairport, New York, May 29, 1905, EBC, "Letterbooks, 1885 -," Archive #2522, Box 1, "Letterbook 11/23/04 - 2/22/06, 345-346.

have been overfilling the cans, but Burnham wrote them and explained "our man" had misadjusted the double seamer and that "we assure you that we shall do everything on our part to see that your can has a most thorough and careful test."⁴⁵ Correspondence during the balance of June and July centered on getting additional cans of different sizes, some coated on the interior and others plain. The relationship between the two companies was mutually satisfactory as exhibited by a July 22nd letter from Burnham when he stated "your attention in the matter [getting cans of different sizes] has been a great accommodation to us, and we wish you to know that we appreciate the same."⁴⁶

The communication for the rest of 1905 centered on placing orders, obtaining replacement parts, can samples, shipping damage, reworking parts, machine safety guarding, expected deliveries, and a small number of quality complaints. The introduction of the sanitary can was going well. Burnham commented on his conversation with William Bogle, their sales agent and the financier behind the sanitary can -- "a pleasant and encouraging conversation with Mr. Bogle on the phone, which we enjoyed very much."⁴⁷ It appeared there were three factors which led to such a successful and relatively flawless introduction of the new can: eagerness to adopt the sanitary can by WCPC for its benefits in terms of cost and rapidity of filling, success running the can attributable to the depth of mechanical skills at WCPC from many decades of making large numbers of their own cans, and SCC's superb customer service.

⁴⁵ Ibid., 362.

⁴⁶ Ibid., 504.

⁴⁷ Ibid., 571.

The following year, 1906, WCPC purchased many of their cans from SCC. On January 30, 1906 they placed the following can order with SCC: 150,000 #2, 80,000 #2.5, 50,000 #3, and 200,000 gallons. The total was 480,000 cans, plus the possibility of some #1 luncheon cans.⁴⁸ This was a substantial order following 12,000 cans a little more than eight months earlier and nothing in 1904. The price for gallon cans was 4.15 cents each. WCPC was very pleased with the sanitary cans and said in February 1906 "we used your can for the first time last season for packing Rhubarb, Apples, String beans, Baked Beans, and Fruits of all kinds with very satisfactory results. We also used your can for packing beets . . . we find that they have held their color perfectly, which is very gratifying to us."⁴⁹ Undoubtedly, the relationship with William Bogle and the company's reputation as the leading regional canner played roles in the rapid adoption of the novel can by WCPC. The mechanical competency of WCPC, garnered from years of manufacturing large quantities of their own cans, made running the sanitary can much less problematic than it might have been for a smaller operation. Price was certainly a factor, as the large order for gallon cans at a little over 4 cents each substantiates. Finally, SCC was very amenable to providing whatever assistance was requested by WCPC in placing orders for other sizes, different linings, and switching delivery dates. In short, WCPC had many factors which allowed them to be a successful early-adopter of the sanitary can, and their experience was probably not typical of most other

⁴⁸ WCPC to SCC, Fairport, New York, January 30, 1906, EBC, "Letterbooks, 1885 -," Archive #2522, Box 1, "Letterbook 11/23/04 - 2/22/06," 947.

⁴⁹ WCPC to SCC, Fairport, New York, February 1-3, 1906, EBC, "Letterbooks, 1885 -," Archive #2522, Box 1, "Letterbook 11/23/04 - 2/22/06," 953-954, 958.

contemporary canning operations.

In 1906, the Wayne County Preserving Company switched from a combination of self-manufacture and supplementing their can requirements with outside contractors to purchasing all their can requirements from can-making specialist companies. The overriding reason was cost -- it was less expensive for them to buy from can companies than manufacture their own tin cans. William Miller, the former can-maker and now factory superintendent for WCPC, responded to a December 1905 inquiry "in reference to floating machines" by explaining how WCPC employed two Lewis floaters, one for the tops and the other for the bottoms, each capable of floating five cans at a time. These floaters were used "in connection" with a Phelps seamer. The capacity on the line was "twelve to fifteen thousand [per hour] 2# [sic] cans, and believe we are doing it as cheap, if not cheaper, than any similar line making the same quantity." Miller believed the price of the Lewis floaters at \$150 each "as being fair" due to "light repairs," and "little about the machine to get out of order." Additionally, the Lewis floaters were "very economical in the use of solder as any floater we have ever used." Miller then transitioned from answering questions about the can-making equipment to a proposal to sell the equipment to H. I. Matthews of Ontario, Canada. He stated that "owing to the very strong fight that is being waged by the large can makers, we find that we can buy our cans this year from \$1.00 to \$1.50 per thousand less than we can possibly make them and have almost decided not to start up our can shop this season but buy our cans at the very low price that they are being offered at the present time." Miller concluded

his letter by stating that in addition to the floaters, WCPC would also dispose of its Phelps seamer and "some of our other can machinery," and if they were interested, "we might be able to offer you a deal that would be very much to your advantage."⁵⁰ Production records for 1906 substantiate that 1905 was the final year WCPC manufactured a portion of their own can requirements. The proportion of cans they had been making themselves had been declining for several years. The "produce summary" for 1906, for the first time, only spoke to cans "packed" and not "cans manufactured." The quantity was 1,624,866.⁵¹ In summary, WCPC exited the can-making business, wanted to sell their unneeded can-making equipment, and had decided to purchase all their can requirements from specialist can-making companies because it was cheaper than making cans themselves. If Miller's figure of \$1.00 to \$1.50 less per thousand cans is assumed to be correct, just by purchasing all their cans from can companies, WCPC saved over \$2,000 in 1906.

The Pure Food and Drugs Act of 1906 had a minimal effect on Wayne County Preserving Company. WCPC was a well-known firm and was most likely not the type of proprietor targeted in the legislation. Nevertheless, the company took two actions to insure compliance with the law. First, the United States Department of Agriculture serial number was now printed on the labels of all tin cans packed by WCPC. The serial number provided the consumer with traceability in the event there were quality

⁵⁰ Mr. W. M. Miller of WCPC to Mr. H. I. Matthews, Lakeport, Ontario, Canada, December 6, 1905, EBC, "Letterbooks 1885 -," Archive #2522, Box 1, "Letterbook, 11/23/04 - 2/22/064," 861-862.

⁵¹ EBC, "Production Records and Accounts, 1906," Archive #2522, Box 53, "Produce Summary 1906," 191.

problems with the can or its contents. Second, a standard guarantee was printed on all invoices. This guarantee was also kept on file with the U. S. Department of Agriculture.

The guarantee stated:

We, the undersigned, do hereby guarantee that the articles of food manufactured, packed, distributed, or sold by us, viz., canned fruits, canned vegetables, and pickles are not adulterated or misbranded within the meaning of the food and drug acts, June 30, 1906.

November 26, 1906
Newark, New York
Wayne County Preserving Company
Edgett and Burnham Proprietors,
per
[Signed E. K. Burnham]⁵²

There are a number of important observations that can be drawn from the business practices of WCPC. First, they made relatively rapid progress, in a span of roughly ten years, through the first three phases of technological development. They began by self-manufacturing cans using craft practices in the 1860s, but had progressed to the "proto-mechanization" phase by the mid- 1870s. They remained in this phase until the mid-1880s when they adopted semi-automatic machinery for making cans. The reasons for doing so was to increase throughput and reduce labor costs. Second, as their business grew, the manufacture of cans was of secondary importance, while reducing costs became paramount. They acknowledged cost was a factor in ceasing internal manufacture of cans in late 1905, but their prior actions and the increasing number of orders placed with can making specialists illustrate cost control was a major factor in their decision. Third, purchases from can-making specialists demonstrated a

⁵² EBC, "Letterbooks, 1885 -," Archive #2522, Box 1, "Letterbook 10/18/06 - 6/28/1910," 13-14.

pattern of continued cost reductions for cans over time. The price for a #3 can declined nearly 30 percent in the span of two years from 1901 to 1903. The mainstay of their business, the #2 can, cost slightly under 2 cents each by the turn of the century. Fourth, WCPC readily adopted the sanitary can. It quickly came to represent almost 25 percent of its business in a span of months from their first trial run of the new can. The reasons for quick adoption were because it was more amenable to rapid filling, less costly than the hole-in-cap cans they were manufacturing themselves, the supreme customer service provided by SCC, and their longstanding relationship with William Bogle.

The case study of the Wayne County Preserving Company illustrates the annual cyclic nature of a late nineteenth-century cannery, and the challenges it faced. There were certain activities conducted during specific parts of the calendar year, and packing season was always the most hectic time of the year. It is an example that would be generally applicable to many canneries, or at least those with a seasonal product mix, as we will see in our next case study.

The H. S. Mill Canning Company

The H. S. Mill Canning Company was a small, local cannery located in Springtown, Pennsylvania. It was situated on a minor waterway, Cook's Creek, which eventually flowed into the Delaware River, approximately fifteen miles away. The cannery was in the northern portion of Bucks County, Pennsylvania, less than a mile from Northampton County. The largest towns near the H. S. Mill Canning company were Quakertown, Allentown, Easton, Riegelsville, and Bethlehem, Pennsylvania. The owner of the

cannery, Henry S. Mill, was born in 1850. His family had been residents of Bucks County since the late eighteenth century. His grandfather, George Mill, was born in 1790 and served in the War of 1812. George recruited a company for the conflict and was voted their captain -- a sign he was a local citizen of some prominence.⁵³ Henry's father, Solomon, and mother, Elizabeth, had amassed a rather large net worth of fifteen thousand dollars in real estate by 1870, when Henry was still living with them. Henry's occupation in 1870 was a clerk in his father's general store, located on Main Street in Springtown.⁵⁴ Henry was married sometime in the 1870s to Clementine Laubeck and they had two children, Minnie and Clinton, born in 1879 and 1881, respectively. Tragically, Henry and Clementine had two other children who died in infancy.⁵⁵ In 1880, Henry and Clementine were living in Springtown with Clementine's brother, Milton Lauback, and a boarder named Jacob Young. Henry's occupation in 1880 was still that of a clerk in his father's store.⁵⁶ The interesting aspect of Henry Mill's early life was that there was no indication he, nor any member of his family, ever farmed or was involved with canning.

Henry Mill became interested in canning only later in life, his activities had been centered on operation of the family general store. The store was a mainstay of town life and occupied a central location on Main Street in Springtown. Mill's Store, as it was

⁵³ *Riegelsville Standard*, 16 April, 1886.

⁵⁴ United States Department of the Interior, Census Office, *1870 United States Federal Population Census*, National Archives: College Park, Md., Film No. 552813, 36.

⁵⁵ Durham Evangelical Lutheran Church Cemetery Records, Durham Township, Bucks County, Pennsylvania, transcribed by Nancy Seiner and Marjory Payne, 1992.

⁵⁶ United States Department of the Interior, Census Office, *1880 United States Federal Population Census*, National Archives: College Park, Md., Film No. T9-1107, 131.

known locally, was a two-story structure, with prominent full glass windows, a four-post awning on the bottom floor, and four windows on the top floor. There were wooden posts in front of the store for local customers to hitch their horses and wagons.⁵⁷ In addition to operating the general store, Henry opened the cannery sometime in the late 1880s. Henry recognized there was a need for a local source to pack, preserve, and distribute the many agricultural products of the region. He was well situated to open a cannery as his location was in the midst of productive agricultural land. Even though his family had little experience as farmers or canners, they were merchants and businessmen first, but obviously recognized a potentially profitable venture. The cannery began on a very small scale in the late 1880s and operated until 1927 when it burned down and was never rebuilt.⁵⁸ There are no existing records to indicate that the H. S. Mill Can Company ever manufactured their own cans. However, given the late date of inception and the growing prominence of specialist can companies, it can be assumed they bought most of their can requirements from outside sources, rather than engage in self-manufacture, as this was a diminishing trend by the late 1880s.

The cannery was a relatively small operation, never packing more than 450,000 cans a year, or about one-fifth the size of the Wayne County Preserving Company. In a 1907 letter to a wooden box supplier, Mill stated he needed 19,750 crates, the

⁵⁷ Postcard Collection, Spruance Library, Bucks County Historical Society, Doylestown, Pennsylvania, SC 36, Cat: 42-026.

⁵⁸ The dates of opening and closure of the H. S. Mill Can Company come from discussions with Springtown residents Bob Hill and Karen Freeh. Bob is the owner of Village Center Automotive and his business sits on the site of the former cannery. Karen is a local historian and member of the Springtown Township Historical Society. I thank them for their patience and time.

dimensions of which could hold 24 cans each, and he "thought of giving you the first chance, should you care to make them." The order suggested an expected pack in 1908 of 474,000 cans.⁵⁹ The operation consisted of three main buildings and two sheds. In a 1907 letter requesting a quote for insurance, Mill stated the buildings "are of frame construction with slate and asbestos roofing." Additionally, "the insurance we had on it and wish to place on it is \$9000." The three main buildings consisted of two warehouses where canned goods, can boxes, and empty cans were stored. The final building was the cannery (see Figures 4.1 and 4.2). There were two floors in Mill's cannery. The first floor had machinery for processing products and raw materials. The second floor stored machinery and empty cans. Mill told the potential insurance agent that "the insurance is to cover buildings, machinery, cans, shocks [wooden boxes], canned goods, stock, and miscellaneous articles found or used in a plant like this."⁶⁰ The sum of \$9,000 of insurable property to cover the entire cannery implied this was a modest operation. Mill made no mention of a can shop or any type of can-making apparatus in his request for a quote on insurance. Finally, two 1908 photographs emphasized the small, local nature of the H. S. Mill cannery. The cannery occupied flat, open ground and had a wire fence enclosing the facility. There were five buildings, including the sheds. At the time of the photograph, the cannery was in the midst of husking corn. The twenty employees in the photograph husked the corn and conveyed

⁵⁹ H. S. Mill Canning Company to T. A. Klinker, Bingen, Pennsylvania, December 18, 1907, "H. S. Mill Canning Company Letterbook, 1905-1908," 477. Klinker was a local supplier and located a few miles from the cannery, a further suggestion the Mill cannery conducted most business locally.

⁶⁰ H. S. Mill Canning Company to Mr. Arthur R. Arche, Philadelphia, August 3, 1907, "H. S. Mill Canning Company Letterbook, 1905-1908," 408.

the ears to the second floor of the cannery.⁶¹ Even if there were employees absent from the photograph, the number of employees surely did not exceed fifty, even in the midst of the pack season.



Figure 4.1 - H. S. Mill Canning Company - Former Site. This is the original site of the H. S. Mill Canning Company in Springtown, Pennsylvania. The present automotive repair facility sits upon the original foundation of the former cannery. Photograph taken by the author in April 2014.

⁶¹ Postcard Collection, BCHS, SC 36, Cat: 42-003, 42-004.



Figure 4.2 - H. S. Mill Canning Company - Original Corn Crib. This corn crib is the only remaining original structure on the site of the former cannery in Springtown, Pennsylvania. Photograph taken by the author in April 2014.

Mill's third business venture, that of a managing partner in various railroad schemes, indicated he was more interested in marketing his products than making cans. Mill was nominated by Colonel John Jameson, owner of the Quakertown and Eastern Railroad (Q & E RR) in 1896 for a seat on the board of directors.⁶² The Q & E RR operated a single track line from Quakertown to Riegelsville, a distance of thirteen miles. The 1896 prospectus of the Q & E RR stated that "the road will develop one of the richest, most industrious, prosperous, and thickly settled section in Eastern

⁶² Quakertown and Delaware River Railroad Collection, Spruance Library, Bucks County Historical Society, Doylestown, Pennsylvania, MSC 171, Folder 2.

Pennsylvania undeveloped by railroads passing through and contingent to nineteen towns and villages." The prospectus stated that the distance from the terminus at Riegelsville to Philadelphia was twenty two miles, "shorter than other railroads," and the line was perfectly situated to haul "undeveloped raw materials, such as wood, stone, dairy, farming, visitors / tourists, and the peach industry."⁶³ The Q & E RR never developed the volume of rail traffic to make it a viable concern, encountered financial difficulties in 1904, and ceased operations shortly thereafter in 1906. Because local residents viewed a railroad as a path to economic security, Mill led another attempt in 1911 to form the Quakertown and Delaware River Railroad, but this line failed by 1916.⁶⁴ The residents of Springtown never again had a rail spur leading to their village. Mill was left to ship his products and secure his cans from rail lines terminating in Quakertown, Bingen, and Riegelsville, using truck or wagon transport to get them to or from his cannery.

Henry Mill may have been neither a large national participant in canning, nor a successful railroad magnate, but he was a prominent local citizen. He owned and operated the only general store within miles, employed many local residents during packing season and even some during the off-season, and made several attempts to have a permanent railroad link for the town. As such, he had the most elaborate residence in Springtown, located on Main Street, a few blocks from both his store and cannery. His home occupied a corner lot and was surrounded by a low stucco wall. A

⁶³ Ibid., Folder 8.

⁶⁴ Ibid., Folder 4.

1908 photograph showed the wooden home was two-stories, with three windows per floor, and had a porch in front. The first floor had a bump-out window, certainly an expensive and uncommon feature for the day. There were two chimneys at Mill's home, an indication it was a large home and required more heating capacity than other homes in Springtown. Mill also had his automobile parked in front of his house -- a further indication he was a wealthy local resident.⁶⁵

The H. S. Mill Can Company operated on an annual cycle similar to the Wayne County Preserving Company. There was an ebb and flow to the business cycle and generally two seasons: preparation and packing. December through early summer were spent preparing for the packing season and included activities such as establishing prices, taking orders, moving remaining inventory from the previous pack, contracting for supplies, and repairing machinery. For example, Mill placed his 1908 requirements for wooden crates to hold the packed cans with George E. Lockwood of Philadelphia in February 1908 and requested 16,050 crates with a capacity for slightly under four hundred thousand cans.⁶⁶ Lockwood appeared to be a general supplier of canning machinery and supplies, as Mill used him to purchase other items, such as solder and machinery parts. Labels were ordered through Simpson & Doeller of Baltimore for products with a H. S. Mill brand name, such as "Excelsior Peaches," "Iron Mountain Pears," "Excelsior Tomatoes," and "Luxury Wax Beans." Customers also sent their own

⁶⁵ Postcard Collection, BCHS, SC 36, Cat: 42-001.

⁶⁶ H. S. Mill Canning Company to George E. Lockwood & Company, 308 Chestnut Street, Philadelphia, Pennsylvania, February 17, 1908, "H. S. Mill Canning Company Letterbook, 1905-1908," 494.

labels to H. S. Mill to use on non-branded products.⁶⁷ Orders for replacement parts for machinery were often sent directly to major machinery vendors. Mill requested parts for a No. 2 double seamer from Max Ams in late July 1905, just before the height of packing season, an indication he used sanitary cans.⁶⁸ He also used the Sprague Canning Machine Company for much of his processing equipment, as he asked them for replacement parts for an apple paring machine in August 1906.⁶⁹

The late summer months and most of the fall were spent buying produce, packing the products, and shipping orders. Most of the produce was procured locally, as was the case for most early twentieth-century canners. While George Olney, a WCPC can-maker, worked in canning plants in New York State, his observations were applicable to small canners nationwide, including Pennsylvania. According to Olney, in the early twentieth century, canners purchased products from farms within a five mile radius of their plant and "a few out to eight miles." This limited transportation costs as most raw product was moved to the canneries by horse drawn carts. The sourcing situation changed by the 1920s with the advent of trucks. Olney claimed, "it enabled the packers to draw their raw product from a longer distance. We used to draw about

⁶⁷ H. S. Mill Canning Company to Simpson & Doeller Company, Baltimore, October 27, 1906, "H. S. Mill Canning Company Letterbook, 1905-1908," 260.

⁶⁸ H. S. Mill Canning Company to Max Ams Company, July 31, 1905, "H. S. Mill Canning Company Letterbook, 1905-1908," 9.

⁶⁹ H. S. Mill Canning Company to Sprague Canning Machine Company, Chicago, Illinois, August 3, 1906, "H. S. Mill Canning Company Letterbook, 1905-1908," 198.

fifteen or twenty miles with a truck."⁷⁰ Trucking created more competition among local canners leading to consolidation and closure of some facilities.

Quality issues also occupied some of Mill's time, normally during the packing season. In November 1906, Mill had a complaint from a customer regarding swelling of the contents of packed sugar corn. The rate of the defect was "2 or 3 cans / case," and considering the number of cans per case was 24, this was an extremely high defect rate. He sent samples to Edward Duckwall, a chemist by training who operated a laboratory for canners in Aspinwall, Pennsylvania. Mill requested Duckwall "to investigate this as soon as possible and let us know your opinion as to how we could detect the corn that would not be suitable, so as to be sure we have no corn on the market that would in any way make us trouble."⁷¹ Mill believed his problem was in the raw product and not how it was processed. At the same time, he also sent samples to another renowned canning expert, A. W. Bitting. Mill explained the rate of defect he encountered and information on how he packed the corn -- filled at 170°, capped and tipped, and processed at 242° for 70 minutes. The brine solution inside the cans consisted of six pounds of salt and four pounds of sugar in fifty gallons of water. He mentioned to Bitting he believed the problem was "due to corn sweating on piles overnite."⁷² There is no record of the

⁷⁰ "George J. Olney Oral History Manuscript," interview by Edward F. Keuchel, 12 July and 8 November, 1963, New York State Food Processing Industry Oral History Project, Archive #2378, Transcript #1206, 6-9, 45-47.

⁷¹ H. S. Mill Canning Company to Edward Duckwall, Aspinwall, Pennsylvania, November 15, 1906, "H. S. Mill Canning Company Letterbook, 1905-1908," 285. The first National Canners Association (NCA) laboratory was founded by the NCA and Duckwall in Aspinwall in 1907.

⁷² H. S. Mill Canning Company to A. W. Bitting, Special Agent, Lafayette, Indiana, November 15, 1906, "H. S. Mill Canning Company Letterbook, 1905-1908," 286.

answers provided by either Duckwall or Bitting, but Mill continued to ask both experts about packing questions and the best places to purchase seed corn.

The H. S. Mill Can Company had a dearth of technical and mechanical skills compared to the Wayne County Preserving Company. The engagement of outside experts for his 1906 corn packing problem was one example of limited technical skills within his operation, but there were other instances. Many of his requests for mechanical support and assistance were plaintive in nature. He had purchased a Hawkins Capper from his canning equipment supplier, George Lockwood, sometime before 1904. In a July 1905 letter to Lockwood, Mill explained that his firm had problems running the machine the previous season and were in need of assistance. Mill stated "we had a little trouble last season with our capper, and wish you would send a good man to put same in good order."⁷³ His request is an indication they had no one capable of repairing a machine quite common in early twentieth-century canneries. Additionally, he had little technical talent for the different processing requirements for his varied products. Shortly after his 1906 corn problem, Mill requested a "first-class processors book" from *The Trade*, which was the most renowned and respected canning publication in the United States. He later requested a copy of "A Complete Course in Canning" from *The Trade* and indicated that if "they liked it, they will buy it."⁷⁴ The lack of mechanical and technical skills are indications the H. S. Mill Canning Company was a

⁷³ H. S. Mill Canning Company to George Lockwood, July 17, 1905, "H. S. Mill Canning Company Letterbook, 1905-1908," 7.

⁷⁴ H. S. Mill Canning Company to "The Trade," Baltimore, Maryland, May 7 & 11, 1906, "H. S. Mill Canning Company Letterbook, 1905-1908," 128, 134.

small, regional participant in the canning industry, but also one where the owner recognized the limitations of his operation. Henry Mill was first a merchant, and secondarily a canner.

The H. S. Mill Can Company, like WCPC, had an ongoing relationship with William Bogle. He was a supplier of many items required by them, especially tin cans, an agent for selling their goods, and a trusted business confidant. Perhaps owing to the lack of mechanical skills or other business considerations, there is no indication the H. S. Mill Canning Company ever made their own cans. Mill's correspondence is absent any requests for steel, can-making equipment, replacement parts for can-making equipment, and data on cans produced internally. Bogle was their primary supplier for tin cans. At least as early as 1905, Mill was purchasing cans through Bogle & Scott. In August 1905, Mill requested a "small car" of cap-hole cans and specifically requested gallons and #2 sized cans, and advised not to ship #3 as they "got enough."⁷⁵ Later in 1905, Mill ordered an entire rail car of #2 cans, approximately 100,000 cans and caps of 1 ½ inches in diameter.⁷⁶ Ordering cans from Bogle & Scott continued through 1906 and 1907. In August 1907, Mill requested they purchase a car of 75,000 corn cans (#2) specifying these be "cap-hole" cans, and later requested this car be changed to a mix of #2 and #3 cans.⁷⁷ Finally, in a February 1908 Mill ordered 200,000 cap-hole cans for the 1908 packing season, with "one car to be delivered in March, the other in April." He

⁷⁵ H. S. Mill Canning Company to Bogle & Scott, 105 Hudson Street, New York, New York, August 5, 1905, "H. S. Mill Canning Company Letterbook, 1905-1908," 11.

⁷⁶ Ibid., September 9, 1905, 27.

⁷⁷ Ibid., August 8, 1907, 409; September 14, 1907, 423.

directed that these cans be shipped to Bingen, Pennsylvania, as this was the closest railhead to his cannery.⁷⁸ In addition to cans, Mill asked Bogle & Scott to purchase crates for cans and some labels for them.

Henry Mill kept Bogle & Scott informed on general crop forecasts, specific sales orders, and goods available for shipment, as they were crucial to his operation. During the packing season in 1905, Mill told Bogle "he was uncertain whether they will need more corn cans because the crop is not large." When Bogle inquired whether Mill could pack goods other than pears, Mill responded that he was "packing pears now and cannot divert labor to ship other goods because the pears will spoil."⁷⁹ Similarly, Mill advised in August 1907 to "expect a poor Kieffer Pear crop and they will cost twice the price of last year."⁸⁰ Mill also advised Bogle when he had problems with customers, as most of these customers had purchased H. S. Mill packed products through Bogle & Scott. In response to problems packing pears in 1906, Mill wrote to Bogle "Leggett's are howling for their goods, but it is their own fault as they wanted another label and it made us a lot of trouble to get it."⁸¹ In another instance of a customer claim for spoiled goods, Mill told Bogle to "straighten out this matter as best you think."⁸² Finally, Mill regularly sent Bogle & Scott listings of packed goods available. For example, in March 1906 Mill wrote Bogle and stated he had 46 cases of gallon peaches, 50 cases wax beans, 175 cases Crystal Wax Beans, 70 cases of #2 Refugee Beans, 95 cases of #3

⁷⁸ Ibid., February 17, 1908, 496.

⁷⁹ Ibid., November 6, 1906, 274.

⁸⁰ Ibid., September 9, 1905, 26; August 17, 1907, 413.

⁸¹ Ibid., December 7, 1906, 301.

⁸² Ibid., March 1, 1907, 349.

Refugee Beans, 475 cases of #3.5 Refugee Beans, as well as limited quantities of succotash and corn.⁸³ Bogle & Scott were more than just an outlet by which Henry Mill marketed his goods. They were certainly Mill's largest customer, jobber and wholesaler, but also a business confidant.

The role played by Bogle & Scott as business advisors indicated a paternal and deferential relationship between them and Henry Mill. William Bogle was the industry expert and knowledgeable about many matters unknown to the industry novice Henry Mill. On two occasions in 1907, Mill requested technical advice from Bogle & Scott, another indication of insufficient technical acumen within Mill's plant. In April, Mill indicated he was "hesitant" to pack potatoes because he did not know the process and asked Bogle's advice. Similarly, in May Mill asked a question and advice from Bogle on how to process and equip a plant to sell tomato pulp. Mill had a potential customer in Baltimore that wanted his refuse from tomato processing. Mill ended this letter with the plaintive request "is this a paying proposition?"⁸⁴ As business advisors, Bogle & Scott would also float short term loans to H. S. Mill. Mill also owed Bogle & Scott considerable sums of money at times, an indication of the poor cash flow position and the diminutive nature of his factory. In October 1906, Mill indicated a check for \$1,996.90 had been sent to Mill's cannery, rather than Bogle & Scott, from Austin, Nichols & Company. Mill indicated he was "short on money" as he was buying apples

⁸³ Ibid., March 23, 1906, 97.

⁸⁴ Ibid., April 17, 1907, 368; May 16, 1907, 382.

and pears, and that they would "like to keep the check."⁸⁵ In early January 1908, Mill requested a \$1,000 advance for goods in Bogle's possession that were awaiting sale as he was apparently having cash flow difficulties again. Bogle sent him a check and Mill responded with several notes of gratitude and wrote "we received a check of \$1000 which has been placed to your credit with thanks." The two parties held a year-end meeting in New York City in late February 1908 to discuss Mill's indebtedness to Bogle & Scott. Mill wrote that "we find in looking over our accounts that we owe you about \$1000 besides the Commission and interest. We will leave this matter until I come over to you."⁸⁶ Bogle & Scott were can suppliers, sales agents, business advisors, and financiers, to a degree, for the H. S. Mill Canning Company. The small regional cannery in Springtown, Pennsylvania owed much of the reason for their continued existence to the close, personal, and deferential relationship with Bogle & Scott.

The H. S. Mill Can Company began experimenting with the sanitary can in 1905, and by 1908 it comprised roughly two-thirds of their can requirements. The reason for their relatively rapid adoption of the can stemmed from its lower cost, its ease of filling, and most likely, their deferential relationship with Bogle acting in his capacity of a business advisor. The trials of the sanitary can began in late 1905 with an order of 300 cans. Mill experienced 150 leaking cans. There is no record of why the cans failed, but Mill sent the Sanitary Can Company a bill for \$50 in losses on this trial.⁸⁷ Obviously, the

⁸⁵ Ibid., October 24, 1906, 257.

⁸⁶ Ibid., January 17, 1908, 484; January 24, 1908, 489; February 21, 1908, 499.

⁸⁷ H. S. Mill Canning Company to Sanitary Can Company, Fairport, New York, September 5, 1905, "H. S. Mill Canning Company Letterbook, 1905-1908," 32; Ibid., January 20, 1906, 85.

quality problems and claim were resolved because in 1906 Mill continued orders, culminating in one for 110,000 sanitary cans of various sizes in May 1906.⁸⁸ By this time, Henry Mill had made a decision to adopt the sanitary can as the container of choice for a large amount of his packing. The balance of the correspondence for 1906 revealed a typical customer - supplier relationship: a pattern of releasing orders for shipment, adjusting quantities ordered, and inquiries on when orders would be delivered. For example, in late July Mill advised SCC to "drop back an order" for later delivery and increase an order for gallon cans from 5,000 to 10,000. In late August, Mill sent a letter of inquiry on this order and asked why the 10,000 gallon cans were late and when they would receive the 20,000 other #3 plain sanitary cans. He added, "we have been looking for that car of cans for about two weeks."⁸⁹ Interestingly, there is no evidence in Mill's inquiries to suggest anything but a cordial relationship between the two companies.

In the following two years, the H. S. Mill Canning Company began using the sanitary can for a majority of their can requirements. In January 1907, Mill placed an order with SCC for a large portion of their annual requirements. The order was for 290,000 sanitary cans, or roughly 60 to 70 percent of their needs. The order was for #2, #2.5, #3, and 300x508 cans, with some of the #2s being enameled inside. The delivery

⁸⁸ Ibid., May 28, 1906, 150.

⁸⁹ Ibid., July 21, 1906, 193; August 31, 1906, 213.

dates were to be confirmed "at the convention in Buffalo."⁹⁰ Less than a week later, Mill advised SCC that their requirements for #10 cans were "undetermined," but that they would also need 60,000 to 65,000 "cap-hole cans, but cannot say for sure. Will advise in 2 weeks."⁹¹ It is unclear from the correspondence whether the above total for cap-hole cans was the annual estimate for Mill, but it does indicate they were using both style cans even though the sanitary can was becoming a greater proportion of their business. Later in 1907, Mill added orders for another 40,000 sanitary cans to their annual requirements.⁹² The annual contract for sanitary cans in 1908 was for 245,000 cans, exclusive of gallons, a slight decrease from 1907. There is no indication of why the order decreased, perhaps poor economic conditions, but the total suggests sanitary cans remained the predominant can used at the H. S. Mill Canning Company. The annual order for 1908 again covered the same sizes as 1907, with #2 and #3 cans being the most common sizes.⁹³

Price data for sanitary cans is often difficult to find in written correspondence because it is competitive information and highly sensitive. There are, however, some indications of what H. S. Mill paid for their sanitary cans. In late July 1907, Mill sent a claim to SCC for \$6.43 for 390 empty #2 cans damaged in transit from the factory in Fairport, New York. The claim was sent to SCC because the "PRR [Pennsylvania Railroad]

⁹⁰ Ibid., January 26, 1907, 321. The annual packed volumes for H. S. Mill are based upon their order for crates for the cans, see fn. 59 and fn. 66. A 300x508 can is 3 inches in diameter and 5 ½ in height. See Table 3.1 for more information.

⁹¹ Ibid., February 1, 1907, 327.

⁹² Ibid., March 6, 1907, 351.

⁹³ Ibid., February 17, 1908, 495.

refuses the claim." The price for the cans was 1.65 cents each, less than the prevailing rate of 2 cents a cap-hole can.⁹⁴ The master contract for 1908 is much more revealing on pricing data. The prices for the most common sizes were 1.575 cents for a #2 plain, 1.8 cents for a #2.5 plain, and 2.1 cents for a #3 plain. The most expensive can ordered was an enameled #2.5 can at 2.425 cents. The annual contract also requested SCC to provide "two Max Ams double seamers fitted with feeding device for #2 and #3 cans."⁹⁵ In summary, the sanitary can was less expensive than the cap-hole can and was amenable to expedited filling; therefore it was readily adopted by the H. S. Mill Canning Company. Their prior business relationship with William Bogle was likely another factor influencing the rapid adoption of the sanitary can by a small, relatively unsophisticated canner like Mill's Springtown, Pennsylvania operation.

The records of the H. S. Mill Can Company lend insight into retailing practices and pricing for canned foods in the early twentieth century. Henry Mill began his business career as a merchandise retailer in his general store, so he took pains to document correspondence with his sales agents. Bogle & Scott were his primary sales agents, but Mill also used others sales agents selling on commission. The second tier of sales agents engaged by the H. S. Mill Canning Company, after Bogle & Scott, were Ira S. Fallin & Company, E. C. Cooke, Schock & Shafer, and James & Washington, all located in Philadelphia. The sales agents were sent goods from H. S. Mill, sold them at the price

⁹⁴ Ibid., July 30, 1907, 405. The price for a cap-hole can is estimated based upon data from the Wayne County Preserving Company and what they were paying vendors in Baltimore in the early 1900s.

⁹⁵ Ibid., February 17, 1908, 495. The contract was written on SCC letterhead stationery and listed Indianapolis, Indiana and Bridgeton, New Jersey as their plant locations, in addition to Fairport, New York. Their business was growing beyond the east coast by late 1907.

suggested by Mill, informed him of what they sold and to whom, and thereby earned a commission on the sale. An example from 1906 is illustrative of this process. Mill sent a letter and payment to E. C. Cooke, one of his sales agents in Philadelphia, and stated "enclosed is a check for \$29.78 Commission for the following goods." Mill then listed seven transactions from August through December 1906 to five different customers for which Cooke was the sales agent. The sales were for canned cherries, peaches, corn, pumpkins, pears, and Refugee Beans totaling \$1,489.15. For these sales, Cooke received a 2 percent commission or \$29.78.⁹⁶ This was a mutually satisfactory relationship. Mill sold his products without investing in a full-time sales force, and his sales agent earned a commission without having to purchase the products. As long as the commission paid by Mill was less than what it would have cost him to have a dedicated sales force peddling his products, it was a beneficial arrangement.

Henry Mill also sold small quantities of his products to local retailers on a direct basis, without the intercession of an agent or broker. Most of these retailers were from nearby Bethlehem and Allentown. In 1905, he quoted prices for tomatoes, corn, peaches, and beans to the South Bethlehem Supply Company. The prices ranged from 5.83 cents for a #2 can of corn to 20.83 cents for a #10 can of Yellow Pie Peaches.⁹⁷ G.H. Kleppinger of Allentown was another frequent local customer. In October 1905, Mill sent him a price list for two brands of corn, cherries, blackberries, wax beans, apples,

⁹⁶ H. S. Mill Canning Company to E. C. Cooke, Front and Chestnut Streets, Philadelphia, Pennsylvania, December 12, 1906, "H. S. Mill Canning Company Letterbook, 1905-1908," 304.

⁹⁷ H. S. Mill Canning Company to South Bethlehem Supply Company, August 24, 1905, "H. S. Mill Canning Company Letterbook, 1905-1908," 19.

pumpkins, and pears. The two brands of corn were for different labels packed by H. S. Mill: Iron Mountain and Excelsior. The Iron Mountain label sold for 6.25 cents a can, while the Excelsior was 5 cents a can.⁹⁸ Customers might request their own label affixed to can, but in the absence of these instructions, Mill packed specific labels associated with his cannery. A year later, he sent another price list for pears to Kleppinger. In this letter, Mill listed two varieties of pears, and one of the varieties had two grades. The Clapper Favorite Pears sold for 12.5 cents a can, while the Kieffer Pears were 9.58 cents a can. These were both for #2.5 sized cans. The lower grade No. 2 Kieffer Pear sold for 7.08 cents a can.⁹⁹ From Mill's correspondence with Kleppinger we can determine that pricing depended upon the variety of a similar product, grading of the same product, but also branding established by the canner.

Mill's letters to local retailers indicate a shrewd knowledge of branding his products and how best to sell them. In 1908, Mill sold three different brands of tomatoes: Iron Mountain, Excelsior, and non-branded. The non-branded can was intended for a customer who desired to affix their own label to the can. In a January 1908 letter to H. S. Gotschall, a merchant from Boyertown, Mill listed the prices for the Iron Mountain and Excelsior tomatoes at 9.17 cents and 7.92 cents a #2 can, respectively. A few weeks later, Mill sent a price list to John P. Clausen, a Washington, D.C. wholesale grocer. He did not include any of his branded products in the letter, but

⁹⁸ H. S. Mill Canning Company to G. H. Kleppinger, Allentown, Pennsylvania, October 9, 1905, "H. S. Mill Canning Company Letterbook, 1905-1908," 40.

⁹⁹ *Ibid.*, November 23, 1906, 291.

listed a non-branded #2 can of tomatoes for 5.83 cents a can.¹⁰⁰ The differentiation in price between Iron Mountain, Excelsior, and the non-branded tomatoes ranged from 9.17 cents a can to 5.83 cents, quite an extensive spread. Customers paid for the expectation of better quality through purchasing a brand name product. Henry Mill was also equipped to offer retailing advice to his small customers. In the same 1908 letter to H. S. Gotschall, Mill offered him some suggestions on pricing his products. Gotschall had wanted a specific type of wax bean, but Mill had none and presented him another option. Mill wrote we "do not have the cut wax beans you are looking for, but can give you a crystal wax bean in a 2 ½ pound can costing you 95 cents [per 12 can case or about 8 cents per can]. This gives you a larger can and a cut bean which can be retailed at 12 cents, or if sold close at 10 cents."¹⁰¹ Mill's pricing suggestion implied that the mark-up wholesalers placed upon goods received from the cannery ranged from a high of 50 percent to a low, if selling "close," of 25 percent. However, regardless of the margin enjoyed by the canner or retailer, consumers were paying much less for canned goods than they were in the late nineteenth century, and the goods were readily available from a multitude of suppliers.

The case study of the H. S. Mill canning Company is instructive for several

¹⁰⁰ H. S. Mill Canning Company to H. S. Gotschall, Boyertown, Pennsylvania, January 24, 1908, "H. S. Mill Canning Company Letterbook, 1905-1908," 488; H. S. Mill Canning Company to John P. Clausen, Washington, D.C., February 18, 1908, "H. S. Mill Canning Company Letterbook, 1905-1908," 497.

¹⁰¹ H. S. Mill Canning Company to H. S. Gotschall, Boyertown, Pennsylvania, January 24, 1908, "H. S. Mill Canning Company Letterbook, 1905-1908," 488. Mill paid 1.8 cents for a #2.5 plain sanitary can, see fn 95. In this transaction, the can represents 22 percent of the price he is charging a retailer, or 15 percent of the retail price of 12 cents a can he is suggesting to Gotschall. If Mill sold a can to a customer at 8 cents, his production cost must be somewhat lower. Therefore, the cost of a tin can was more than 22 percent, and probably somewhere around one-third, of his total production costs. Assuming a 50 percent margin, a can sold to a customer at 8 cents probably cost Mill around 5.4 cents to manufacture.

reasons. First, it was a small operation, compared to the Wayne County Preserving Company, and probably more typical of the hundreds of canneries dotting the American countryside. There were many more operations similar to Mill's cannery than there were large, regional, or even national firms. Canning was a distinctly local endeavor in the late nineteenth and early twentieth centuries. Mill's cannery did use many modern pieces of equipment for the packing process, such as sanitary cans, Ams seamers, Hawkins Cappers, and Sprague processing equipment, but it was not a particularly leading-edge firm that pioneered new innovations, practices, or procedures. Second, the H. S. Mill Canning Company bought all their cans from cannery equipment suppliers or can-making specialists. Their focus was on canning and not can-making, which is unsurprising given they were a late entrant to the canning industry. Because the prices of tin cans had decreased enough through new technology and the rise of can-making specialist firms in the late nineteenth century, Mill did not need to establish a can-making operation at his factory. The lack of a can-making operation had a disadvantage, however, for the third point -- the reliance upon outsiders for mechanical and technical skills. Henry Mill did employ modern processing equipment, but was dependent upon outsiders to maintain and instruct his employees on its operation. He also made requests for assistance and guidance from Bitting and Duckwall in resolving his quality problems and made an appeal for instruction on processing products to leading technical publications. Henry Mill did understand enough about the industry, however, to at least know who to contact for professional information.

The relationship between the H. S. Mill Canning Company and the firm of Bogle & Scott is enlightening on two levels. First, Bogle & Scott acted as a multifaceted business partner and provided Mill with cans and other supplies to operate his cannery, sold much of his product, and offered sage business and technical advice. Bogle & Scott were seasoned veterans of the canning industry, had constructive relationships with other canners, such as the Wayne County Preserving Company, and their knowledge of the industry spanned many decades. Their services as a supplier, sales agent, and business advisor were invaluable to an industry neophyte such as Henry Mill. It would have been very difficult, if not impossible, for the H. S. Mill Canning Company to have continued in business absent their relationship with Bogle & Scott. Second, the close partnership between Mill and Bogle & Scott undoubtedly played a role in the quick adaptation of the sanitary can by Henry Mill. William Bogle was the financial backer of the new Sanitary Can Company, so he sought additional customers for the new style can. Within a few years of the successful introduction of the sanitary can, between 60 and 70 percent of Mill's can requirements were fulfilled by the new can. The sanitary can was quickly adopted by Mill not only because its price was slightly less than the cap-hole can, but it was also easier to fill. The H. S. Mill Canning Company thus provides additional insight on how the sanitary can came to completely replace the hole-in-cap can within two decades.

Finally, the H. S. Mill Canning Company case study demonstrates how early twentieth-century canneries sold their products and confirms a continued trend of

decreasing consumer prices for canned foods. The Mill retailing system consisted of three components: national, regional, and local distributors. Located in New York City, Bogle & Scott, their primary sales agent, could reach a national customer base. However, Mill also engaged at least four other sales agents to sell his product. His second tier sales agents were regional and all located in Philadelphia. The second tier sales agents received products from the cannery at no cost and sold them at prices suggested by Henry Mill. They earned a 2 percent commission for the product they sold. The final level of distribution for Mill was local direct sales to smaller merchants, wholesalers, and grocers. Most of these customers were located within a few hours of the factory in Springtown. Henry Mill employed this complex system of retailing to maximize the area in which his products were sold, but minimized his costs by avoiding the expense of a dedicated direct sales force. The prices charged by Mill to local customers demonstrated a continued decrease in the price of canned foods, yet also price differentiation based upon product variety and branding. Retail prices for common items, such as tomatoes, corn, peaches, and pears, were ten to twelve cents per can, almost one-fifth what they cost in the 1860s. With few exceptions, canned food was becoming affordable for many more Americans, and the prices of empty tin cans were now measured in a few pennies.

The Cobb Preserving Company

The Cobb Preserving Company began operations in 1881 in Fairport, New York. Beginning as a canner in the nineteenth century, it transitioned to a specialist can

manufacturer by the early twentieth century. The founder of the firm was Amos H. Cobb, a cousin of Ezra Edgett, the founder and owner of the Wayne County Preserving Company. Prior to becoming a cannery owner, Amos spent the 1860s and 1870s in a variety of occupations. At various times he was employed as a broker or sales agent for his cousin Ezra, selling the canned food produced by him. He was also a partner in a New York City based trading firm specializing in importing various products from England. Amos later worked as a salesman for his father-in-law selling newsprint to the daily metropolitan newspapers in New York City. In 1881, Edgett offered to sell the old and unutilized Fairport canning facility to Cobb. Fairport was located in the midst of bountiful agricultural land, ten miles east of Rochester, New York, and the factory was situated alongside the Erie Canal (see Figure 4.3). Given his previous experience as a broker for canned food and the prospect of beginning his own business, Cobb arranged to purchase the facility and enter the canning business.¹⁰²

¹⁰² May, *Canning Clan*, 84-86.

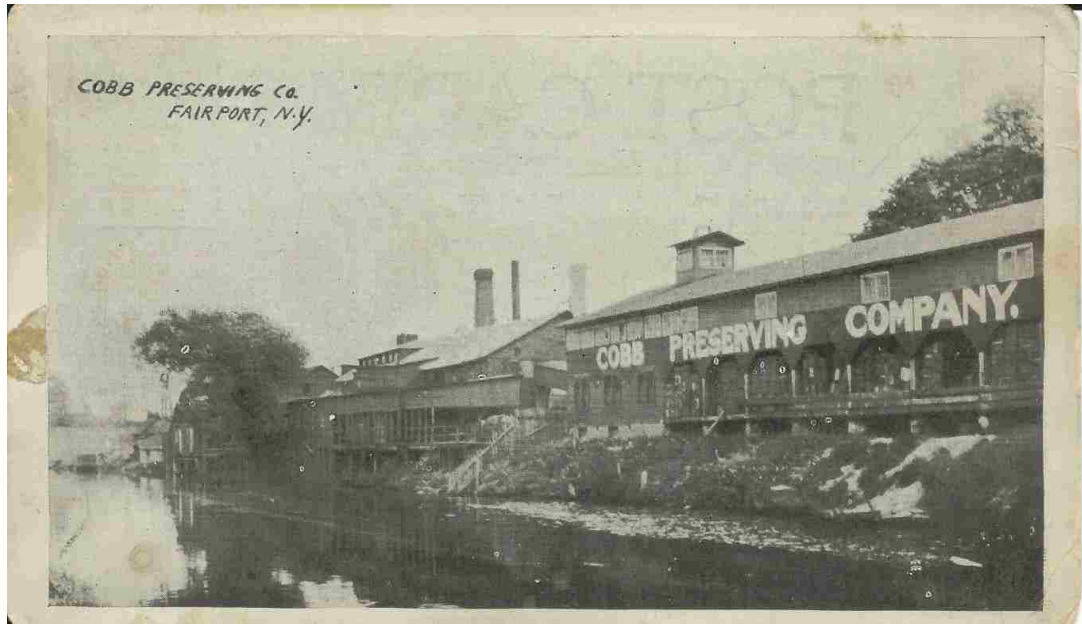

Figure 4.3 - Postcard of the Cobb Preserving Company, Circa 1900. The Cobb Preserving Company of Fairport, New York was the site for the development of the sanitary can. The cannery was located along the Erie Canal, which became the dumping ground for many defective cans.

Amos Cobb had four sons, and they all entered the canning industry. The most prominent of these was his second son, George W., who was the vice president and manager of the Fairport cannery. The business prospered in the 1880s and 1890s and by 1897 was packing two million self-manufactured cans annually.¹⁰³ The firm packed all sorts of local products, but specialized in fruits, jams, and preserves. According to one former Cobb employee, Warren D. Kennell, "the Cobb brand had no equal."¹⁰⁴ The cans were produced by a cadre of six primary can-makers, using many bench devices and a few semi-automatic machines. The methods used by Cobb differed little from many similar can companies. One of Cobb's primary can-makers, Roy Wheeler, recalled

¹⁰³ Ibid., 87.

¹⁰⁴ "Warren D. Kennell Oral History Manuscript," interview by Edward F. Keuchel, 22 July, 1963, New York State Food Processing Industry Oral History Project, Archive #2378, Transcript #1193, 12.

getting an offer of employment from George in 1898, as Wheeler had previously worked for him sealing the vent holes in the cans after the can was processed -- he was a tipper. Wheeler accepted the offer and decided to become a can-maker because "the can maker's job was the highest paid job in the canning business at the time." Additionally, Wheeler had a favorable impression of George Cobb's reputation and noted "George Cobb was the canning businessman there." He was "a fine man and good businessman" and that "the employees liked him."¹⁰⁵

Wheeler's first job as a can-maker at Cobb Preserving was to cut bodies to the proper length and then "roll 5 at a time, and take 200 to your work bench." Wheeler would then solder the side seam on a "spring form" using a "hatchet copper [soldering iron]." The cans were handed to a boy who would attach the top and bottom, then to another boy who would "float" the can. Wheeler described the floating process at Cobb using a bench attached floater:

In this solder pot, there is a knife protruding on an incline from the solder pot, and this knife - there is a frame holding two little wheels about two inches in diameter - you lay the can on the two wheels and down into the solder pot. You have another wheel on a frame about six inches in diameter, and it has a little handle on it. You press down your foot to take a can out, and when you raise up your foot, it lets this wheel come down and you turn the can with your hand on the shaft that lets you roll it around in the solder. After it has rolled around, you take it out and put it on an iron plate to keep the solder level. It cools almost instantly.¹⁰⁶

¹⁰⁵ "Roy E. Wheeler Oral History Manuscript," interview by Edward F. Keuchel, 6 August, 1963, New York State Food Processing Industry Oral History Project, Archive #2378, Transcript #1192, 9-10.

¹⁰⁶ Ibid., 15-16.

Wheeler stated that his "can making team," comprised of himself and two boys, made 3,000 cans in an eight hour shift. For his labor, Wheeler was paid \$2 per day.¹⁰⁷ Given Wheeler's description of the can-making process, Cobb Preserving was between the second and third phases -- "proto-mechanization" and "semi-automatic machinery" -- of can-making technological change in 1898. While there was division of labor within the can manufacturing teams, it was not an integrated process and did not use state-of-the-art can-making equipment.

The sanitary can was introduced to George W. Cobb by William Bogle in December 1897. Cobb Preserving Company became the test site for this new product design. Bogle & Scott sold most of the canned foods produced by Cobb, so they were well acquainted. Bogle had learned of the new can from Charles Ams of the Max Ams Company, a New York City firm that canned and sold fish and other delicacies since 1868. Charles Ams had formed another firm a few years earlier, the Max Ams Machine Company, to manufacture equipment to make the sanitary can. During the 1898 packing season, Cobb canned a small number of pears with the sanitary can. According to George Cobb, "results with the few experimental cans were so satisfactory that an order for a line of can-making machinery was placed with the Max Ams Machine Company." This equipment was delivered in 1899, and Cobb Preserving began larger production runs of the sanitary can. Cobb was enthusiastic about the utility of the sanitary can. He stated "there was the firm conviction that quality could be wonderfully

¹⁰⁷ Ibid., 17-18.

improved, especially in the packing of high-grade fruits and tomatoes." There were two quality problems which he believed the sanitary can would solve. First, he had received complaints from customers of "black specks" in some of his canned products. The black specks were caramelized sugar from the heat of the iron used during capping. If the capping function was eliminated, the black specks would no longer be present in his finished goods. Second, customers also complained of "lacerated fruit" in the cans. The fruit had previously been shoved through the cap of the can, thereby breaking many pieces. The open-top of the sanitary can allowed whole portions of fruit to be packed and eliminated the broken fruit issue. Independent of the quality improvement in canned foods, Cobb also explained that he was "impressed with the advantages from the standpoint of cannery operations," which meant he could reduce and eventually eliminate his capping and tipping force, thereby saving labor and solder costs.¹⁰⁸

There were many trials and tribulations with perfecting the use of the sanitary can and getting it to run. Cobb Preserving had to determine whether the new can was practical and for how long they could sustain losses from their experimentation. The initial test was in 1898, but the period 1899 through 1903 were the key years for commercial development of the sanitary can. Rather than buying small quantities of sanitary cans from the Max Ams Machine Company, Bogle and Cobb endeavored to make their own, with the aforementioned equipment purchase, at Cobb's Fairport, New York cannery. Most of the cans they manufactured were for their own use, but they did

¹⁰⁸ George W. Cobb, "The Development of the Sanitary Can," in Judge, *A History of the Canning Industry*, 95-96.

sell the surplus to other canners whom Bogle thought might be interested in the new can.¹⁰⁹ Progress was slow, costs were high, but according to Cobb "results each season were less disastrous." In 1902 William Bogle and Cobb's brother Frederick were quite frustrated and "ready to abandon the sanitary can." George "earnestly pleaded" for a final trial in 1903, and that season the results were "fairly successful," due to the assistance of redesigned machinery provided by the Max Ams Machine Company. Cobb Preserving began using inside enameled cans in 1903, and in 1904 "packed practically all of their red fruits" with an interior enameled can, with the result that the color and flavor were exceptional.¹¹⁰ In 1904, Cobb Preserving began exclusively making and packing the sanitary can in lieu of hole-in-cap cans.

The painful years of trial-and-error development at Cobb Preserving were acutely experienced by those assigned to make and pack the cans. John Rees, an employee of Cobb Preserving who spent summers during college working in the factory, stated unequivocally that "sanitary cans were started in Fairport, that is the machine sealed can." Rees noted that there were many problems with the development of the can, particularly swells. Most of the experimentation at Cobb was with fruits, but as they overcame problems, they packed other products -- peas, beans, corn, and tomatoes. There were problems with these vegetables, primarily with pressure cooking, but through trial-and-error they also surmounted these issues. According to Rees, "year after year it [the sanitary can] became more effective and it got to a period where we

¹⁰⁹ *United States v. American Can Company, et. al.*, 230 F. 890 (D. Md. 1916).

¹¹⁰ Cobb, "The Development of the Sanitary Can," in Judge, *A History of the Canning Industry*, 96.

felt pretty secure with our work with pressure cans." Rees also believed the sanitary can offered advantages similar to those extolled by George Cobb. Rees stated "we needed the open top can, really, so that you could put fruit in without breaking it up through the top hole cap."¹¹¹

In the first few years of the twentieth century, Roy Wheeler was removed from his crew making cap-hole cans at Cobb Preserving and moved to the development work on the sanitary can. Wheeler correctly recounted that "somebody had the idea, I think it originated in New York City . . . that they could make the open top can, and that it would be a big benefit to the canning industry to have the whole top of the can open." He noted that George Cobb was a strong proponent of the can: "Mr. Cobb was very much interested and he was a stickler for the open top can." However, the initial experiments were discouraging. Wheeler declared "I know from my experience in making these open top cans that so many poor ones were made that we filled the canal [Erie Canal] with them. That was during the experimental days." Yet George Cobb's persistence and belief that "they were practical," combined with the support of "a wonderful man in New York who had some means . . . it was W. Y. Bogle," insured the continuation of the development work. The manufacturing problems encountered by Wheeler were primarily the accumulation of solder at the ends of the side seam which made double seaming difficult. Wheeler and his compatriots overcame these production issues by soldering the can cylinders horizontally, rather than vertically, and

¹¹¹ "John Rees Oral History Manuscript," interview by Dr. George Hucker, 7 April, 1964, New York State Food Processing Industry Oral History Project, Archive #2378, Transcript #1234, 6-8.

eventually utilized a new method of seaming using the lock seam.¹¹² There was little resistance to the sanitary can from can-makers, according to Wheeler. He argued that "they [can-makers] could see the advantage of it. Anybody could. If I told you that you had to fill a can down through a little hole, and then solder it up and dot it, and then I put a can in the machine and, zip! It's sealed and sealed perfectly - you could put those cans in those machines anywhere you wanted. But to make them by hand?"¹¹³ Wheeler believed that the sanitary can was so much easier to manufacture, that can-makers had no cause for complaint. It was a practical innovation, in his observation, and a great benefit for canners.

Charles Ams, Bogle, Frederick and George Cobb were so enthusiastic about the successful development at Cobb Preserving, and commercial possibilities of the sanitary can, that they formed a separate company for commercializing it in 1904. According to George Cobb, "so rapidly was the sanitary can gaining favor that by 1904 it was decided to organize a separate company for the manufacture and sale of sanitary cans." The Sanitary Can Company began making cans in July 1904, and later was incorporated on December 15, 1904. The key founders, officers, and owners of the new company were William Bogle, President, Frederick Cobb, Vice President, and William Cobb, Secretary, Treasurer, and General Manager. Charles Ams was on the Board of Directors, along with the three officers. Ams agreed to provide the double seaming equipment needed

¹¹² "Roy E. Wheeler Oral History Manuscript," interview by Edward F. Keuchel, 13 September, 1963, New York State Food Processing Industry Oral History Project, Archive #2378, Transcript #1192, 19-24.

¹¹³ Ibid., 31.

for the new firm. The Sanitary Can Company began business in a vacant shoe factory in Fairport, New York. Their first shipment of cans was to the Golden Gate Packing Company of San Jose, California.¹¹⁴

One of the first operational matters addressed by SCC was increasing their output. Initially, the company began can-making operations with semi-automatic turret type side seamers and a lap style seam. These machines could make 25,000 cans in a ten-hour day. However, the double seamers provided by the Max Ams Machine Company ran much faster than the turret side seamers. Additional speed was required to match the side seaming and double seaming, therefore SCC purchased two Ayars Machine Company lap style side seaming machines and their combined output was 36,000 cans in a ten-hour day. While adequate to maximize throughput, there remained a specific technical problem with the sanitary can. When a lap style seam was rolled into the can top or bottom and double seamed, there were five layers of metal at the juncture of the can end and side seam. This juncture was problematic, a source for leakage, and often came apart when the ends were attached. In order to alleviate this issue, Ams developed a process of notching -- cutting off the corners of the body blank. This process was done as can cylinders were formed and removed the excess metal, as well as slightly bending the edges of the body blank. The seam was formed by interlocking the notched and bent edges, compressing them together, and soldering the outside of the seam. This process became known as the lock and lap side seam. No

¹¹⁴ Cobb, "The Development of the Sanitary Can," in Judge, *A History of the Canning Industry*, 96. 256

longer were there five layers of metal at the juncture of the side and double seams. SCC then achieved speeds 66,000 cans per ten-hour day using the lock and lap side seam. This innovation matched the speed of the Ams seamers to the side seaming operation, and also resolved the primary technical impediment for expedited manufacture of the sanitary can. The lock and lap side seam became the standard process for use with the sanitary can.¹¹⁵

The years immediately following the founding of SCC were characterized by enormous growth in sales of the sanitary can. In the first year of operation SCC made eight million cans and had revenues of \$150,000.¹¹⁶ During the next four years, can volume doubled every year and revenues stood at \$2 million annually by the beginning of 1908.¹¹⁷ Between 1904 and 1908, SCC opened new plants in Bridgeton, New Jersey, Indianapolis, Indiana, and Niagara Falls, Ontario, as well as expanding the facilities in Fairport. According to can-maker Roy Wheeler, "the new can grew by leaps and bounds." Wheeler, due to his knowledge of the new can, was sent on trips to customers attempting to run the sanitary can. During a visit to Van Camp & Company in Indiana, he observed one million #3 cans run and stated they "didn't find enough leakers to mention." Wheeler was later directed to get the new SCC lines running in New Jersey, Indiana, and Canada. Notably, he never experienced any hostility from workers when

¹¹⁵ May, *Canning Clan*, 90-93.

¹¹⁶ Cobb, "The Development of the Sanitary Can," in Judge, *A History of the Canning Industry*, 96; *United States v. American Can Company, et. al.*, 230 F. 890 (D. Md. 1916). The price of a sanitary can, according to the data for 1904, was 1.9 cents each.

¹¹⁷ May, *Canning Clan*, 93; *United States v. American Can Company, et. al.*, 230 F. 890 (D. Md. 1916).

installing the new machinery.¹¹⁸

The rapid growth and expansion of SCC strained their finances. They began with \$150,000 in capital stock in 1904, but needed additional cash to finance expansion. In 1907 SCC increased the capital stock to \$1,000,000 and also issued \$500,000 in preferred shares. Most of the stock was purchased by close friends of Bogle and Cobb.¹¹⁹ Despite the additional financial resources, SCC had a few problems in the field with their cans. Many cans were claimed to be defective by canners, therefore SCC was paying large sums in claims to many of their customers. The dual pressures of strained finances and payment of large field claims were further exacerbated by economic downturn in late 1907. The Panic of 1907 caused alarm among the officers of the company and their primary investors that SCC might not be capable of meeting their financial commitments. According to government documents, "they [officers and investors] feared they had on hand more of a task than their means would enable them with safety to handle."¹²⁰ The officers of the company decided to sell SCC. The American Can Company (ACC), then the largest manufacturer of cans in the country, was the most viable option as they had financial resources to purchase and assume all the SCC stock and had previously expressed an interest in the sanitary can.

Negotiations between SCC and ACC on a potential sale began in January 1908, and the sale was consummated in March 1908. Bogle and Cobb had discussed a sale

¹¹⁸ "Roy E. Wheeler Oral History Manuscript," interview by Edward F. Keuchel, 18 October, 1963, New York State Food Processing Industry Oral History Project, Archive #2378, Transcript #1192, 25-31.

¹¹⁹ May, *Canning Clan*, 93; Cobb, "The Development of the Sanitary Can," in Judge, *A History of the Canning Industry*, 96.

¹²⁰ *United States v. American Can Company, et. al.*, 230 F. 890 (D. Md. 1916).

price for the company as somewhere between \$50 and \$150 per share -- quite a spread. They were offered \$150 per share, or a price three times the value of invested capital, making the total sale purchase roughly \$4.5 million. SCC operated as an independent subsidiary of ACC; both Bogle and Cobb assumed executive management positions and continued to manage the new subsidiary.¹²¹ The purchase of SCC by American immediately made them the largest producer of sanitary cans in the country, and this was a fortunate circumstance, according to George Cobb, for the future of the sanitary can. Cobb stated "when the principal can company in America became sponsor, the sanitary can received great impetus. To the American Can Company, with its organization, manufacturing and mechanical expertise, and its distribution of plants, is due the perfection of the sanitary can and the popularity which it enjoys."¹²² American Can's scale helped diffuse the sanitary can so that it dominated the market by the early 1920s.

The case study of the Cobb Preserving Company is instructive for several reasons. First, breakthrough innovations are often a function of an unmet market-driven need, funding, and perseverance. They can also lead to creation of new demand. The development of the sanitary can by Ams, Bogle, and Cobb was fraught with disappointment and frustration. The challenges of manufacturing were only overcome through trial-and-error over several years. The development of the can was funded

¹²¹ May, *Canning Clan*, 94-95.

¹²² Cobb, "The Development of the Sanitary Can," in Judge, *A History of the Canning Industry*, 96.

through Bogle's financial acumen, and Ams' technical innovations, but Cobb's persistence and conviction that the sanitary can would revolutionize canning maintained the momentum of the project.

Second, Cobb Preserving demonstrates the awkward and incomplete diffusion of can-making technology in the late nineteenth and early twentieth centuries. Before the sanitary can project, Cobb was a canner who also manufactured cans, consuming what was required for their use and selling the excess to other canners. They began with hand or craft practices in the 1880s, but had only progressed to the second or third stages of technological development -- "proto-mechanization" and "semi-automatic mechanization" -- by 1898. The production methods and techniques used by their can-makers substantiate they were not on the leading-edge of technology. Cobb Preserving was not, initially, a can-making specialist firm, so improved can-making machinery for its own sake had little appeal for them. There was no need to invest further in any type of semi-automatic machinery to increase their output or any sort of integrated can manufacturing line. Phase four, "integration," was the realm of the can-making specialists. Cobb Preserving skipped much of the third and fourth phases of technological development in its quest to develop a new can in phase five.

Third, the purchase of the Sanitary Can Company by the American Can Company in 1908 completed the evolution of the technological development cycle from concept and prototype in 1898, through the stages of product development and commercialization, to diffusion and popularization in a period of ten years.

Undoubtedly the financial resources and dominant market position of ACC aided the diffusion of the can, yet the industry behemoth did not play a substantial role in the can's development. This task was performed by others -- Charles Ams, William Bogle, and George Cobb.

Finally, the phenomenal growth of SCC from its formation in 1904 and subsequent sale to ACC in 1908 demonstrated the merits of the new product design. It was a validation of George Cobb's enthusiasm for the project. The relatively rapid adoption of the sanitary can was atypical of technological change in can-making. As the can-maker Roy Wheeler observed, "anybody could" see the advantages of the sanitary can. The price of the new can was slightly less than hole-in-cap cans because of using less solder, the sanitary can was easier and quicker to fill, it had more customer appeal by avoiding broken product inside the can, and the cans were of uniform quality. It quickly became the standard can for the industry, and by the early 1920s, the hole-in-cap can was obsolete. Industry observer Earl May commented that "a 'passing fad' had demonstrated itself to be a revolutionary idea."¹²³

Norton Brothers Can Works

The Norton brothers were sons of an itinerant Presbyterian preacher in the 1840s in northern Illinois, traveling quite extensively on account of their father's calling.¹²⁴ Edwin would become known as one of the great can-makers in the late nineteenth century. Oliver, also Edwin's business partner, complemented his brother's

¹²³ May, *Canning Clan*, 95.

¹²⁴ May, *Canning Clan*, 347.

mechanical ability with his training in finance and accounting. Together, the Norton brothers became the most powerful tandem in early can-making. They were can-makers first and foremost and had neither personal experience as canners, nor did they ever operate a canning plant. As such, there are several important aspects of their business that will illuminate the process of technological change in late nineteenth and early twentieth-century can-making.

Edwin took several jobs as a teenager to earn additional income for his family. His first job was assisting local farmers with the harvest, but the arduous labor and minimal pay soured him on this type work. When Edwin was fourteen, the family moved from Illinois to Toledo, Ohio, where he obtained a job in a hardware store. One department of the hardware store made and sold an assortment of tinware for household use: pails, milk cans, stovepipes, and various utensils. Edwin was assigned to make stovepipes, by hand, which was a difficult and time consuming task because of the curvature in the elbow. He designed a method to simplify the manufacture of the elbow in the stovepipes, for which he was paid \$100 by the owner. Edwin worked at the hardware store as a tinsmith for several years before volunteering and serving with an Ohio regiment during the last year of the Civil War. It was during his Civil War service that he first encountered food served in cans. He became enthralled with the possibilities of growth for canned food, if the containers could be made more expeditiously.¹²⁵

¹²⁵ Ibid., 348-349.

Upon returning to Toledo, Edwin established the E. Norton Company in 1868, which specialized in manufacturing tin cans and other household tinware. The business was successful, but financial difficulties forced him into a partnership to grow the firm. The name of the company was changed to Norton & Fancher in 1870. In 1871, Edwin moved to Chicago, a place he viewed more amenable to a tinware business because of its rapid growth, and established another office and factory for Norton & Fancher at 63 - 65 South Canal Street. In 1873, Edwin purchased his partner's interest in the firm, hired his brother Oliver as accountant, and changed the name of the company to Norton Brothers. The firm relocated the next year to its primary location in Chicago at 44 - 46 River Street, adjacent to the Chicago River and just west of the downtown business district.¹²⁶ At this location, Norton Brothers concentrated on manufacturing tin cans and ceased production of other tinware. The canning industry moved inland from the east coast after the Civil War, beginning in Illinois by the early 1870s. The principal crop was corn, but tomatoes, beans, and various berries were also important. The Libby, McNeill, and Libby Company, along with the Wilson Company, were the largest meatpackers in Chicago. Their demand for tin cans grew substantially with the development of the tapered can. Norton Brothers were well positioned, being located in Chicago, to make cans for the burgeoning fruit and vegetable markets, as well as the meatpacking industry. The closest source of tin cans, for those not inclined to manufacture their own, was located in Baltimore. Norton Brothers were so busy making cans for these

¹²⁶ "Order of Exercises at the Dedication of Norton Brothers' New Factory," Business Records of the American Can Company, Maywood Public Library, Maywood, Illinois, Box G-1.

industries in the early 1880s that they decided to expand their operations.¹²⁷

Land was expensive in Chicago and not readily available, so the Norton's opened a new factory in Maywood, Illinois, located twelve miles due west of downtown Chicago. The Chicago factory was not abandoned, however, and became the site of one of Edwin Norton's most significant achievements in 1883 -- the integrated, "automatic line," described in chapter 3. The new facility was situated in the first ring of suburbs surrounding Chicago, and by the 1880s was serviced by a line of the Chicago and Northwestern Railroad. The land was relatively inexpensive, so it was an ideal location from which the Nortons could expand their can-making enterprise. The initial factory opened in Maywood in 1885, and there was substantial growth over the next few years. In 1890 the Nortons commenced the manufacture of tinsplate in Maywood, and in 1892 they built a foundry for making the frames of their can-making machinery. An unfortunate February 1894 fire destroyed their Chicago can manufacturing plant, eventually forcing Norton Brothers to move all their can-making and administrative offices from Chicago, so the Maywood facility expanded dramatically. In April 1894 a new warehouse for storing cans was opened in Maywood, and a new factory for making cans opened in November 1894.¹²⁸

¹²⁷ May, *Canning Clan*, 349-350.

¹²⁸ "Order of Exercises at the Dedication of Norton Brothers' New Factory," Business Records of the American Can Company, Maywood Public Library, Maywood, Illinois, Box G-1.

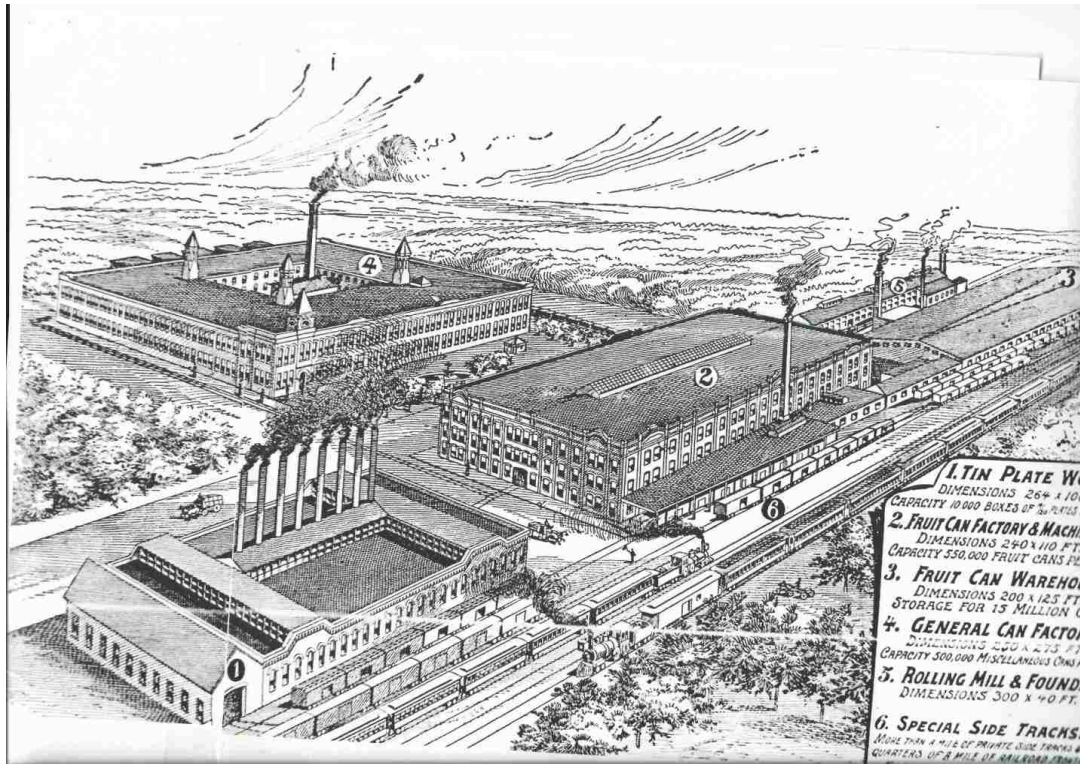

Figure 4.4 - Sketch of the Norton Brothers Can Works, Circa 1894. This sketch of the Norton Brothers Can Company location in Maywood, Illinois was presented to the public at the opening of the facility in 1894. This was the largest can manufacturing facility in the United States in the late nineteenth century. Sketch provided courtesy of the Maywood Public Library, Maywood, Illinois.

The new factory in Maywood was a masterpiece of ingenuity, and certainly one of the largest and most advanced can-making facilities in the country. The architect for the project, F. R. Schock, presented a sketch of the facility to the public at the dedication ceremony (see Figure 4.4). In the foreground were steam-powered locomotives with lines of box cars ready to receive cans and several horse-drawn carts leaving the facility. There were five buildings in Maywood. The first was the 28,000 square foot tinplate works opened in 1890. This facility had the capacity to process 10,000 boxes of tinplate per week, thereby assuring Norton Brothers of an unimpeded flow of their basic raw

material. The second was the newly dedicated "fruit can factory and machine shop." It was a three story structure with a total of 790,000 square feet of space. This was the hub of the operation having the capacity of manufacturing 550,000 fruit or vegetable cans per day. The third building was the new warehouse opened in April 1894. The 30,000 square foot warehouse could store up to 15 million cans. It also had numerous bays from which cans could be loaded onto railcars. The fourth building was the "general can factory" where large fruit or vegetable cans, tapered cans for meat, paint cans, pails, and other "miscellaneous" cans were manufactured. It was two story, 69,000 square foot structure, capable of making 500,000 cans per day. The final building was the 12,000 square foot foundry where the castings for the machinery sold by Norton Brothers was manufactured. The complex had three quarters of a mile of railroad frontage, a mile of private rail lines, and employed between 1,200 and 1,500 workers, depending upon the season. The Norton Brothers facility in Maywood occupied eighteen acres of property.¹²⁹ With a daily capacity of over 500,000 fruit and vegetable cans, it was an integrated and automated facility based upon the principles of Edwin's "automatic line" of 1883, only with higher capacity machinery. It was arguably the largest, most modern, and best capitalized can manufacturing facility in the United States. It was a monument to the rise of a new industry -- specialist can-making.

Norton Brothers prospered in the late 1890s and petitioned the Board of Trustees in Maywood for an ordinance to expand their operations in 1901. This would

¹²⁹ "Sketch of Norton Brothers Maywood Plant," Business Records of the American Can Company, Maywood Public Library, Maywood, Illinois, Box G-1.

be its final expansion as a separate corporate entity. The plans did not necessitate additional buildings, rather they detailed expanded operations within existing buildings by improving water and sewage flow, and linked all of the individual buildings with railroad tracks. It was a plan that integrated the entire manufacturing complex in a fashion similar to the way in which Edwin Norton linked disparate can assembly functions into an "automatic line" in 1883. The purpose of the ordinance, as delineated by the Maywood Board of Trustees, was for "granting permission and authority to Norton Brothers . . . to lay, maintain and operate water pipes and also to lay, maintain and operate railroad tracks in certain streets in the Village of Maywood."¹³⁰ The terms were very favorable for Norton Brothers, as they were one of the largest employers in the village. Most of the language in the ordinance involved laying and operating railroad tracks on village property, with minimal requirements placed upon the firm. Their only obligations were to ensure "tracks when laid shall not be elevated above the surface of the street," where the tracks crossed streets the company was to "keep said crossings in good repair and condition free from obstructions," and to operate the tracks "in a safe manner." Norton Brothers merely had to post a \$5,000 bond for any eventual penalties and indemnify the village against any damages.¹³¹ The area covered under the agreement spanned eight square blocks, and all improvements were financed by Norton Brothers. The ordinance is a testament to the size of the firm and their economic

¹³⁰ "Ordinance Between Norton Brothers and the Village of Maywood, March 14, 1901," Business Records of the American Can Company, Maywood Public Library, Maywood, Illinois, Box G-1, 1.

¹³¹ Ibid., 6.

importance within the community. After being passed on March 14, 1901, it was approved by Norton Brothers the very next day.¹³²

Shortly after Maywood approved the favorable arrangement for Norton Brothers, the company was purchased by the fledging American Can Company (ACC). There were roughly 175 can manufacturing enterprises in the United States in 1901 and ACC purchased over 100 of them. The driving force behind these acquisitions was Edwin Norton. He arranged most of the purchases and was instrumental in rationalizing the new company the first year or two after ACC's inception.¹³³ ACC swiftly closed all but a handful of these acquisitions, and these actions gained the ire of the United States Attorney General leading to litigation in 1913. This story will be investigated in detail in a subsequent chapter. The Norton Brothers plant in Chicago became the centerpiece of the ACC's manufacturing operations (see Figure 4.5). Norton Brothers were the largest and most well-known can-maker in the country prior to acquisition by ACC. In the 1913 anti-trust suit, the presiding court officer, Judge Rose, stated "He [Edwin Norton] and his brothers had been for a number of years the largest and doubtless the most generally known manufacturers of cans in the country . . . the factories of his firm had probably the best equipment of labor saving machinery. Certainly in this respect they were

¹³² Ibid., 8.

¹³³ May, *Canning Clan*, 353.

surpassed by none."¹³⁴ Judge Rose's assessment is an accurate epitaph for the Norton Brothers Can Works.¹³⁵

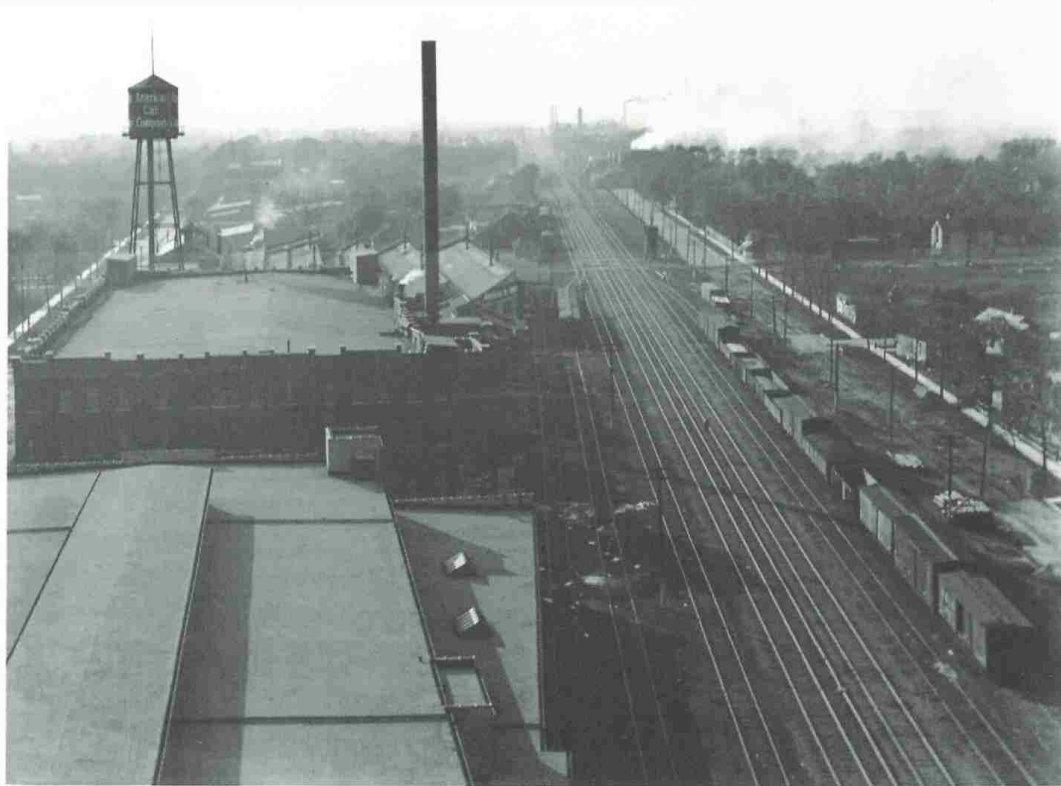

Figure 4.5 - Photograph of the American Can Company Plant - Maywood, Illinois, Circa 1911. The former Norton Brothers Can Company was purchased by American Can Company in 1901. This photograph is looking west along the tracks of the Chicago Northwestern Railroad and illustrates the immense size of the plant. This facility became one of the most important manufacturing centers for American Can Company in the early twentieth century. Photograph courtesy of the Maywood Public Library, Maywood, Illinois.

¹³⁴ *United States v. American Can Company, et. al.*, 230 F. 867 (D. Md. 1916).

¹³⁵ Joseph Sjostrom, "Once-bustling Land to Yield Jobs Again," *Chicago Tribune*, 31 May 2005, sec. 5, p. 1, 4. American operated the Maywood facility for many years and finally closed it in 1975 (see Figure 4.5). The City of Maywood purchased the property in a subsequent delinquent-tax sale and demolished all buildings except the original tinplate works in 1997 (see Figure 4.6).



Figure 4.6 - Contemporary Photograph - Former Norton Brothers Can Works Site. The American Can Company plant was demolished in the late 1990s. The only remaining original structure from the Norton Brothers Can Company is the Tin Mill with the "saw tooth roof" in the background. Photograph taken by the author looking east, July 2013.

Edwin Norton left an indelible impression upon can-making in the late nineteenth and early twentieth centuries. Although he passed away on December 15, 1915, his inventive genius revolutionized can-making. He had little primary schooling and completely lacked any formal technical or engineering instruction.¹³⁶ However, Edwin Norton was captivated by can-making and driven to improve the machines and processes for manufacturing cans. He was the arch-typical independent inventor of the late nineteenth century. The "automatic line" of 1883 revolutionized the process by which tin cans were manufactured, at least for large firms concentrating solely on can-making. His "automatic line" became the standard configuration by which cans were

¹³⁶ May, *Canning Clan*, 352-354.

made, and his sequencing of individual operations is still recognizable on modern can production assembly lines. It was, according to *American Machinist*, "an entire change in the method employed in the manufacture of cans."¹³⁷ According to one source, he held nearly 5,000 individual patents.¹³⁸ Even if this is an overstatement, he did hold patents for many disparate parts of the can-making process and the tin can. For example, Patent 287,048 was issued in October 1883 and was for a testing machine to accompany his "automatic line." Norton even invented his version of a capping machine in 1889 with Patent 395,796, Art of Soldering Caps on Filled Cans. His idea was to solder caps with no vent holes, on cans through gradual application of heat. In his words, "I have discovered, and herein my inventions consists, that can-caps having no vent holes may be successfully and perfectly soldered upon filled cans by gradually heating the joint or can-cap by subjecting it to the action of successive soldering tools or heaters . . . gas may have the opportunity to escape before the soldering operation is complete."¹³⁹ Norton's capping machine never gained much traction within the industry because successive soldering was too slow, but he was always investigating a method to eliminate production problems.

Norton's curiosity was not restricted to machinery and extended to the tin can itself. In 1887 he secured two patents aimed at simplifying seaming operations. Patent 364,662, Sheet-Metal Can Cap, Head, or Blank, was designed to eliminate soldering

¹³⁷ "Norton's Automatic Can Making Machinery," *American Machinist*, Vol. 6, No. 28 (July 14, 1883): 1.

¹³⁸ May, *Canning Clan*, 348.

¹³⁹ Edwin Norton. 1889. Art of Soldering Caps on Filled Cans. U. S. Patent 395,796, filed October 31, 1888, issued January 3, 1889.

either inside or outside the can when attaching an end. The solder was contained in a channel on the end and the seal effected when the metal was rolled together. Patent 370,404, Sheet-Metal Can and the Art of Manufacturing the Same, was similar to his process for improving end seams. The solder for the side seam was captured in a joint between the folds of the side seam. Neither of these innovations became commercially practicable, yet they provide insight into his innovative mind. Norton invented a vacuum-sealed can in 1903 with Patent 717,711. This invention was aimed at the hole-in-cap can, the bottom being attached using solder applied in the normal fashion. The top was loosely positioned on the can, the can inserted in a vacuum chamber, the chamber exhausted, and the can top subsequently sealed thorough evacuation of the air in the chamber. The can was removed from the chamber and a cap soldered on the top. It was too time consuming as a commercial process at a time when sanitary cans were also in development, yet Norton did invent the first vacuum sealed can, and current versions trace their origin to his invention. The depth and breadth of Edwin Norton's inventiveness certainly benefitted Norton Brothers, and thus it was little wonder why Judge Rose acclaimed them as the most technologically advanced can manufacturer in the country during the early twentieth century. A fitting epitaph for the Norton Brothers and their pioneering plant in Maywood was printed in the *Chicago Times* in 1938:

Some day a man with stouter muscle and better wind, though no stouter heart than many who went before, will lick Mt. Everest, and before coming down its 10 to 1 he will leave a memento of Maywood, Illinois, 29,000 feet up in the air. Before the explorer turns from conquest to fight his way back . . . he will toss away the empty container, and there will be Maywood's coat of arms, a tin can couchant on the roof of the world.¹⁴⁰

There are two instructive lessons from the Norton Brothers case. First, they were a unique operation and certainly atypical of the diffusion of technological change in can-making. It was one of the few examples of a firm completely progressing through the first four phases of can-making technology. The primary reason they traveled so far along the path of change was that they were a can-making business first and foremost. As such, the key to their continued existence as a company was to make more cans than their competition, as inexpensively as possible. They began as little more than a tinsmith shop in the late 1860s using craft techniques. Norton Brothers continued to grow and used any available machinery available in the "proto-mechanization" and "semi-automatic mechanization" phases to further their goals of increased throughput and decreased costs. They were the pioneers for "integration" in their Chicago plant in 1883. Simply stated, Norton Brothers required improved machinery to remain in business, so they quickly adopted innovative technology.

Second, Norton Brothers had the great advantage of scale and soon dominated the specialist can manufacturing companies. There were other large can-makers centered in Baltimore, but Norton Brothers quickly controlled the Midwest. The company profited immensely from being one of the first concerns in the Midwest to

¹⁴⁰ *Chicago Times*, 6 November 1938.

concentrate solely on making cans. The markets for fruit and vegetable packing were expanding inland from the east coast, and the meatpacking industry soon came to dominate Chicago. They were well-positioned and made opportunistic use of their business environment to expand their customer base. However, the exceptionally inventive mechanical genius of Edwin Norton, more than any other factor, set the company apart from other potential rivals, even those in Baltimore. Edwin Norton's improvements to machinery, his focus on the can-making process, and his inquisitiveness for perfecting hole-in-cap cans, made Norton Brothers the technology leaders of their time. Edwin was an example of the independent inventor so prevalent in late nineteenth-century America. Edwin's unceasing energy, curiosity, and determination, when coupled with the administrative talents of his brother Oliver, insured success for the firm. Although Norton Brothers was eventually purchased by ACC, their plant in Maywood provided the nucleus from which the latter came to subjugate the market in the early twentieth century. It is important to remember, that although ACC subsequently improved upon its technology, it was nonetheless originally conceived in Chicago and Maywood, Illinois by Norton Brothers.

Large Food Marketers

Even among the largest food marketers of the late nineteenth and early twentieth centuries, diffusion rates of can manufacturing technology were not uniform. Large food marketers generally had a nationwide distribution system for their product, the advantages of size and scale, and national name brand recognition. They

transcended local and regional boundaries, often because of the unique appeal of their specialty products. Firms fitting this description included Campbell Soup Company, Dole Pineapple Company, Borden's Condensed Milk Company, H. J. Heinz Company, and Franco-American Food Company. We have seen how differing business conditions and environments were factors that led some small canners to either make their cans, purchase all of them from a can company, or procure a portion of their requirements from outside sources. This was also the case with major food processors. Whether to self-manufacture or not varied amongst this group of companies. As large concerns, many of these companies had the financial resources to invest in the most modern can-making equipment, but not all of them made this investment.

The Campbell Soup Company was founded by Joseph Campbell in 1874 in Camden, New Jersey. The Joseph Campbell Company was a large, regional canner of preserves, jellies, meats, vegetables, sauces, and fruit. Campbell and his business partner, Arthur Dorrance of Bristol, Pennsylvania, experienced tremendous growth and were well known throughout New Jersey and Pennsylvania. Campbell was the canner and operations expert of the firm, while Dorrance provided much of the financial resources required for the growing firm. Campbell retired in 1894 and sold his portion of the firm to Dorrance, who hired his nephew, John T. Dorrance, to replace Campbell as the operations expert. John Dorrance held a prestigious Doctor of Philosophy degree in chemistry from the University of Gottingen in Germany and had traveled extensively through Europe. There, John Dorrance observed that soup was an important

component of the European diet, yet it was also bulky and expensive. He reasoned that if soup could be concentrated or condensed, the resulting product would be easy to prepare and could be offered at about one-third the price of a ready-made soup. A concentrated product allowed for smaller cans, lowered shipping costs, and reduced other manufacturing costs. Thereafter, the company name was changed to the Campbell Soup Company and focused solely on manufacturing condensed soup. The founders name was retained as the brand had a strong regional customer base. It was John Dorrance's goal to offer his soup at ten cents a can.¹⁴¹

One result of the business decision to focus on producing and perfecting concentrated soup, and not manufacturing cans, was that the manufacturing of the tin cans was done by specialist can manufacturing firms. Campbell Soup began canning in 1895, and purchased cans from a variety of small firms. After the formation of the American Can Company (ACC) in 1901, this new firm became Campbell Soup Company's major supplier. However, when Thomas G. Cranwell, a Vice President for ACC, left the company and became the president of the rival Continental Can Company in 1904, the Campbell Soup Company account moved with him. Campbell Soup was the leading customer of Continental Can and, even in the early twentieth century, one of the largest single consumers of tin cans in the world. By the early 1930s, Campbell Soup Company represented 30 percent of Continental's total business, and purchased over 500 million

¹⁴¹ May, *Canning Clan*, 341-343.

cans annually from the company, primarily #1 and #2 cans.¹⁴² As a preferred customer of Continental, they were offered prices "at perhaps 20 cents a thousand [cans] below the defendant's [American Can Company] prices" in the 1910s.¹⁴³ The Campbell Soup Company depended upon Continental for their can requirements until 1936, when the Robinson-Patman Act, outlawed quantity discounts and differentiated pricing for large consumers or purchasers of any product. It was only in 1936 that Campbell Soup became a self-manufacturer of tin cans. According to John E. Baldwin, a senior sales manager for Continental from 1920 until 1959, self-manufacture got a "big push" with the passage of the Robinson-Patman Act in 1936. He continued, "that's when Campbell's Soup Company had to go into making their own cans." The business loss to Continental Can was significant, but "they [Campbell Soup Company] weren't going to pay the same price for their cans as the company that bought one carload a year." Continental Can sold modern plants and equipment to the Campbell Soup Company and were paid a "management fee" for several years thereafter, but soon the firm required no further technical assistance from Continental Can.¹⁴⁴ The Campbell Soup Company had quickly mastered the process for manufacturing cans with automated equipment plus, as the largest consumer of tin cans in the world, it had the advantage of economies of scale. In summary, the Campbell Soup Company began operations by purchasing tin cans from specialist can companies because they had made a business decision to focus

¹⁴² Unattributed, "Profits in Cans," *Fortune*, Vol. IX, No. 4 (April 1934): 80-81, 134.

¹⁴³ *United States v. American Can Company, et. al.*, 230 F. 892 (D. Md. 1916). The discount was approximately two percent of the list price per thousand cans.

¹⁴⁴ "John E. Baldwin Oral History Manuscript," New York State Food Processing Industry Oral History Project, Archive #2378, Transcript #1220, 61-62.

on producing condensed soup and did not want to be bothered by manufacturing tin cans. However, government legislation eliminated the price advantage they had earlier enjoyed, so belatedly they became self-manufacturers.¹⁴⁵ Their transition to self-manufacturing was not particularly difficult as they had the financial resources to purchase the most modern can-making equipment available on the market, and some technical assistance from Continental Can. As self-manufacturers, with large volumes of relatively common sized cans, they were able to manufacture cans as inexpensively as the two major can companies in the 1930s, American Can and Continental Can.

The Dole Pineapple Company of Hawaii is another case where a large food marketer focused on producing and marketing a product, rather than manufacturing cans. James D. Dole was the Harvard educated descendant of missionaries who had arrived on Oahu Island in the 1820s. Dole engaged the Hunt Brothers of San Francisco, a large west coast packer and distributor of fruits and vegetables, as investors and brokers for pineapples in the early 1900s. In 1903, Dole packed his first pineapples in hand-made hole-in-cap cans provided to him by Hunt Brothers. His first pack was only 1,893 cases, a relatively small output. Dole invited ACC to build a plant in Honolulu in 1906 with the guarantee he would purchase all his can requirements from them. ACC built

¹⁴⁵ The Robinson-Patman Act (RPA) was enacted in 1936 to protect small businesses from the purchasing advantages of larger firms. It sought to limit the ability of large buyers to gain price discounts through the use of their size. The RPA was passed after the emergence of large grocery store chains in the 1930s who were using volume discounts from suppliers to undercut pricing at small, non-chain stores, thereby driving them out of business. Much of the final version of the RPA was drafted by the United States Wholesale Grocers Association. The RPA only applies to sales of commodity items of like grade and quality. For more information see http://www.americanbar.org/groups/young_lawyers/publications/the_101_201_practice_series/robinson_patman_act.html or <http://legal-dictionary.thefreedictionary.com/Robinson-Patman+Act>.

the plant and provided all Dole's can requirements. To create demand for his product, in 1908 John Dole deployed a strategy that had three components. First, he employed specialized salesmen to promote and sell his product. Second, he devised a national advertising campaign to stimulate interest and sales for his product. Finally, he set his price low enough to make pineapple, widely considered an exotic product in the early twentieth century, more affordable and thereby generate interest in adding variety to the household diet. By outsourcing his tin can requirements, Dole was able to concentrate on marketing his product, and within ten years of his first pack the company dominated the national market. By the 1920s he had a nationally recognized brand. Dole even purchased an entire island, Lanai, in 1922 to meet the growing national demand for his product.¹⁴⁶ Similar to the Campbell Soup Company, James Dole recognized that can manufacturing was not a critical component of his business strategy. As such, Dole concentrated branding, marketing, and generating interest in his product, rather than mastering the manufacture of tin cans.

There were several large food marketers that believed self-manufacture was vital to the success of their business and never seriously considered purchasing their can requirements from specialist can companies. The H. J. Heinz Company of Pittsburgh produced ketchup, horseradish, pickles, sauces, and tomatoes. Henry Heinz was born in 1844 and at age twelve working in his father's brick factory, located in Sharpsburg,

¹⁴⁶ Henry A. White, "James D. Dole: Industrial Pioneer of the Pacific," An Address Given in Honolulu, Hawaii to the Newcomen Society in North America on June 27, 1957 (Princeton: Princeton University Press, 1957), 12-22.

Pennsylvania outside Pittsburgh. In addition to working in the brickyard, Henry also maintained a small plot of land upon which he grew vegetables for sale to local customers. By age twenty-one, Henry had purchased an interest in the brickyard, but also expanded his food production business to service the growing oil industry in northwest Pennsylvania. In 1869, Henry decided to sell his interest in the brick factory and dedicate his efforts to growing his food processing business. He formed a company with a wealthy partner from Sharpsburg, L. Clarence Noble, and they named the company Heinz, Noble & Company. The company initially concentrated on producing bottled horseradish. The firm continued to expand their product line in the early 1870s adding vinegar, mustard, pickles, and other condiments. They also opened factories in Woodstock, Illinois and St. Louis, Missouri. Their rapid expansion, extended credit to finance operations, combined with the depressed economy in the mid-1870s forced the company to file for bankruptcy in December 1875.¹⁴⁷

With bleak prospects for financing, Henry Heinz sought financial assistance from family members to form a new food processing company. On February 6, 1876 he began operations as the F. & J. Heinz Company with a line of bottled horseradish, pickles, gherkins, and celery sauce. In addition to selling popular products, Heinz wanted to create demand for new products and commercialize the new offerings through aggressive promotion. Heinz was adamant about managing customer demand, and this drove many subsequent strategic decisions regarding organizational control,

¹⁴⁷ Nancy F. Koehn, "Henry Heinz and Brand Creation in the Late Nineteenth Century: Making Markets for Processed Food, *The Business History Review*, Vol. 73, No. 3 (Autumn, 1999): 355-369.

manufacturing, engineering, and product development. The firm added ketchup in late 1876, despite consumer proclivity for homemade ketchup. Henry believed there was a vast market for this product as a mass-produced food, as long as the product was delectable, customers were assured quality was high, and the product was free from adulteration. To promote ketchup and other products throughout the balance of the nineteenth century, Heinz employed novel promotional techniques such as parades, advertising at county fairs, distributing free souvenirs to the public, newspaper advertisements, offering plant tours to local citizens, adopting the keystone as a symbol for the company, and developing "57 Varieties" as a company slogan.¹⁴⁸ Sales and brand recognition soared.

One of the strategic decisions made by Heinz to manage his brand was backward integration to control manufacturing the containers, both bottles and cans, used in packaging his products. In order to reduce breakage, transportation, and packaging costs, Heinz began using tin cans in 1877. These were all made within the Heinz facility in Pittsburgh. The company took full advantage of the advances in can-making technology throughout the 1880s and 1890s as they had the size and financial resources to purchase the most modern equipment. Then modern technology for can-making, combined with continuous processing on his filling lines, facilitated the expanded scale of his operation.¹⁴⁹ A 1919 promotional brochure for the renamed H. J. Heinz Company boasted about their backward and forward integration. It was intended to reassure

¹⁴⁸ Ibid., 369-383.

¹⁴⁹ Ibid., 388-390.

customers that Heinz was connected to the customer and directed every facet of their production processes from planting crops to delivering products. Among the vital statistics were Heinz's 6,523 employees, 100,000 acres for growing crops, 25 factories, 87 raw product receiving stations, 258 company owned railroad cars, 952 salesmen, and 55 branch offices and warehouses. They also mentioned that "we own and operate our own Bottle Factory, Box Factories and Tin Can Factory."¹⁵⁰ Heinz could manufacture his containers as inexpensively as the specialist can companies because of the company's size and adoption of the latest technology. However, control of his entire enterprise, not reducing can costs, was the driving force behind his decision to backward integrate and become a self-manufacturer of tin cans. Heinz believed that a reputation for quality, through total control of the production process, was the key to building his business and brand with customers.

The quest to reassure customers of the safety and quality of their production control process was also the reason the Franco-American Company self-manufactured tin cans. Founded in the late 1880s by immigrants from France, the Biardot family, the company was based in Jersey City Heights, New Jersey. Franco-American produced expensive, non-condensed soups which had gained a reputation for quality by the late 1890s. The company believed a "prejudice existed against soup even when made at home," and they "felt it would be ten times stronger against a soup put up in a tin

¹⁵⁰ E. D. McCafferty, *Henry J. Heinz: A Biography* (New York: Bartlett Orr Press, 1923), 106-107.

can."¹⁵¹ In order to counter this impression, the firm invited the public to tour their manufacturing facility and published a booklet in 1897 for those consumers who "on account of distance, or lack of time, have not visited our factory."¹⁵² The literature was designed to inform and persuade the public of the virtues of canned soup. The pamphlet began with a description of the Franco-American can-making department. The opening sentence stated that "all cans used in our factory are made by ourselves, and for that purpose we employ none but tinplate made specially [sic] for us, and of a grade superior to that supplied to other canned goods manufacturers." The accompanying sketches included a neatly groomed and attired operator sitting behind a pendulum press and a row of similarly nattily-clad can-makers standing alongside a long work bench using hand tools. The description below the row of can-makers was "All Cans are made by ourselves." Franco-American was somewhere between phases two and three of can manufacturing technology. There was no integration of the can-making operation, even in the late 1890s. The attachment of the tops and bottoms was done "by the aid of an ingenious machine, all the soldering being done on the outside of the can, the inside of which remains untouched by hand, and free from solder." The cans were then "washed in two waters before being filled, so as to further insure their perfect cleanliness." Franco-American claimed to have "brought cleanliness to a science."¹⁵³ Clearly the booklet was meant to reassure customers on the cleanliness,

¹⁵¹ A. Biardot, *Franco-American Soups: How They Are Made* (Jersey City Heights, N.J.: The Franco-American Food Company, 1897), 3.

¹⁵² *Ibid.*, 4.

¹⁵³ *Ibid.*, 5-6.

order, quality, modern manufacturing methods, and control Franco-American placed upon the entire process from can-making to filling their self-manufactured tin cans with soup. For Franco-American, self-manufacture was not a method to reduce costs, but a practice to insure the stringent control of their production process, thereby reassuring potential customers.

The Borden Condensed Milk Company was also a self-manufacturer of cans, but there were technical reasons for their decision, in addition to their desire to manage the entire production process. Borden's used a "hole-in-top" can, which was slightly different than the hole-in-cap can. The hole-in-top can, also known as the "venthole" can, was made from three pieces of metal, versus four for the hole-in-cap can. The venthole can was popular for canners filling a liquid product such as condensed milk. The product was inserted through a small hole in the top of the can and sealed almost immediately by a tipper using a small dab of solder. There was neither a large opening in the top of the venthole can, nor the need for a cap. Borden's self-manufactured for several reasons. First, the hole-in-cap can was the predominant style of can manufactured by specialist can manufacturers, so their manufacturing processes were not geared to this specialty type of container. Given its relative lack of availability, it was also a slightly more expensive product. Second, the method for manufacturing condensed milk required tight process controls. Close control of the manufacturing process led to a corporate culture inclined to backward integrate and manufacture their own containers. Finally, Borden's large volume of business provided them with

economies of scale for self-manufacture. Borden's also had the financial resources to purchase the most modern can-making equipment. As a result, even if a specialist can-making enterprise agreed to manufacture venthole cans, they probably could not have sold them at a price lower than the self-manufactured cost at Borden's. These elements of the business environment made self-manufacture a logical decision for the company. Nearly every one of their major plants in New York, Connecticut, and Illinois had a can-making department. The "can room" at the facility in Elgin, Illinois was capable of making 10,000 cans a day by the 1880s, so it was equipped with modern technology.¹⁵⁴

In summary, there was no singular model for the diffusion of technology or decision on whether or not to self-manufacture by large food marketers. While large food processors certainly had the scale, size, and financial resources to manufacture their own cans with modern technology, not all of them did so. The strategic decisions made by the companies in the five case studies considered in this section all differed because of the particular circumstances of the business environment in which they operated. There were three general rationales for selecting the style of manufacturing systems within large food marketers. First were those that self-manufactured to reduce costs, such the Campbell Soup Company after 1936 and Borden's from their inception. These firms had a relatively uncomplicated mix of size requirements for their cans and volumes that provided them with economies of scale. They could also afford and indeed purchased the most modern can-making equipment on the market. As

¹⁵⁴ Franz, *Gail Borden: Dairyman to a Nation*, 264.

summarized by John Baldwin of Continental Can, "if you could set your line on one size can and run it all the time without changes and so forth, without loss of labor in changing, without spoilage -- a certain amount comes out of every line before you make the cans perfectly . . . that's where these canners that have gone in to making their own cans have an advantage. They only have to make one or two sizes -- set their lines up . . . and run."¹⁵⁵ The second rationale was to self-manufacture in order to extend corporate control over the entire manufacturing process. Heinz, Franco-American, and to some extent Borden's used this justification for self-manufacture. These firms desired to present an image of quality, safety, and management control to reassure the public and build their brand. They often had extensive amounts of forward integration, such as a dedicated national sales force, national advertising, or a distribution network, and backward integration within their firms. Finally, the rationale to avoid self-manufacture and purchase cans from a specialist can company was rooted in a prevailing desire to promote a product and focus on the core business. The early history of the Campbell Soup Company and that of Dole exemplified this decision making process. These companies focused on creating markets for soup and pineapple, relatively uncommon consumer products at the time, to the exclusion of manufacturing. Self-manufacturing of cans would have complicated their operations and drained creative energy from their primary business objectives.

¹⁵⁵ "John E. Baldwin Oral History Manuscript," interviewed by Edward F. Keuchel, 15-16 April, 1964, New York State Food Processing Industry Oral History Project, Archive #2378, Transcript #1220, 60-61.

Conclusion

The case studies indicate a non-uniform pace of technological diffusion within can-making in the late nineteenth and early twentieth centuries. The progression of technological change was slow, uneven, and highly differentiated. This should not be surprising given the rapid expansion of canning in the late nineteenth century, as indicated by census data. The participants within the industry during this time had unique business environments which conditioned their business decisions. Factors affecting whether to make or purchase tin cans included the overall objectives of the business, size of the operation, location and availability of skilled labor, desire for control of all facets of the canning process, available capital to invest in machinery, focus on building a brand, proximity to specialist can-makers, the mechanical skill resident within the firm, and costs to manufacture containers. One view of technological progress and economics dictates that when more efficient machinery was available, canners would purchase it to remain competitive and reap the rewards from the new innovation. This was clearly not the case with many nineteenth-century canners. Even if new technology was available, many continued to manufacture with older technology, so long as they controlled costs and remained profitable. In his study of Delaware canners from 1860 to 1940, Dean Doerrfeld reached the same conclusion. While Doerrfeld studied canners and not can-makers, his conclusions are applicable to both industries. He stated that "Delaware canneries retained other forms of nineteenth-century technology well into the twentieth century." Doerrfeld explained

how Delmarva Peninsula canneries continued to peel and pack tomatoes by hand until the 1970s, while California producers had adopted machinery as early as 1916. Some Delaware canneries processed peas in the 1950s using technology installed in the early twentieth century. His conclusion was that "as long as a cannery continued to produce goods that sold at competitive prices, new equipment was unnecessary."¹⁵⁶

Few canners progressed beyond phase three, semi-automatic manufacture, in the typology of can-making technological development, when they manufactured their own tin cans. The Wayne County Preserving Company began to purchase from specialist can manufacturers as they employed some semi-automatic machines. The H. S. Mill Canning Company never, apparently, invested in any can-making equipment. Cobb Preserving used semi-automatic machines when they transitioned to developing the sanitary can. Even some large food marketers, such as Franco-American, continued to manufacture using semi-automatic machines and bench tools until the late 1890s. The cost and expense of integrated can-making, phase four, limited the number of firms for which this method of manufacture made economic sense. Large food marketers, such as Heinz, Borden Condensed Milk, and Campbell Soup after 1936, had the scale of operations to justify the expense. The other integrated can-makers were the specialist firms, such as Norton Brothers. Their core business was predicated upon manufacturing at lower cost than canners could possibly make cans themselves. The progression along the path of technological development was also not linear, and often skipped a phase.

¹⁵⁶ Dean A. Doerrfeld, *The Canning Industry in Delaware; 1860- 1940 +/-: A Historic Context* (Newark, Del.: University of Delaware Press, 1993), 41.

The Wayne County Preserving Company, the H. S. Mill Canning Company, and Cobb Preserving all skipped phase four, but were early adopters of the sanitary can, phase five of technological development. The new product was more amenable for maximization of throughput, and also offered at prices slightly less than the existing hole-in-cap can.

The case studies also illustrate a trend amongst canners of purchasing cans from outside suppliers and can-making specialists in the late nineteenth century. Wayne County Preserving Company and the H. S. Mill Canning Company both shifted large quantities of their can requirements to specialist firms. The reason was cost -- specialists could manufacture them less expensively. This was the period in which R. Tyne Smith, Norton Brothers, and later American Can Company and Continental Can Company came to dominate the can-making industry and obviated the need for internal, self-manufacture. This trend applied to all canners, except some of the large food marketers. The large food marketers, such as Heinz or Borden Milk, had the scale, financial resources, and limited product complexity to make self-manufacture a viable economic option for them. The major exception was the Campbell Soup Company. They continued to purchase from Continental Can well into the 1930s, but once they began self-manufacture using modern machinery, they quickly mastered can-making and became the third largest can company in America, behind only American and Continental.

Finally, the case studies indicate a continued trend toward lowered prices for tin cans and a resultant growth in the canning industry. In the 1860s a tin can cost twenty-

five cents using craft manufacturing techniques; but by the early twentieth century, a sanitary can sold for less than two cents. There were several interrelated factors causing this price contraction. First, technology allowed more throughput and less labor in the manufacture of cans, so costs for tin cans decreased. Regional canners who adopted even the most rudimentary technology saw can costs decline dramatically. Second, the rise of the can-making specialists and the sanitary can were significant factors in accelerating lower prices for tin cans. The specialists lowered can prices through the application of integrated technology. The sanitary can allowed canners to more rapidly fill cans. Finally, as the cost of tin cans decreased and the sanitary can increased throughput, canners could lower the price of the packed products offered to consumers, thereby spurring demand. The correspondence from the Wayne County Preserving Company and the H. S. Mill Canning Company, demonstrate the declining prices for canned goods. The cycle of declining can prices being passed along to consumers in the form of lower prices for the finished product made canned foods affordable for most Americans.

Chapter 5 - Consolidation of Can-Making

The cleanest metal-working operation known to an industrial age must surely be that of a can factory. Celerity is the word which from first to last characterizes can making.

Arthur Pound, 1936¹

Cleanliness and speed in can manufacturing impressed Arthur Pound when he wrote those words in the 1930s. These qualities were the products of a twenty-five year period of industry consolidation, for few can factories in the late nineteenth century would have fit his description of the industry in the mid-twentieth century. The rise of a distinct can-making industry in the 1880s decoupled it from canning. With this phenomena began the slow pace of consolidation within can-making. The new can-making industry had a few large concerns, but the slow diffusion of technology insured there were many small can-makers, and also those canners who produced their own cans. The merger mania of the last decade of the nineteenth century and early twentieth century are noteworthy for can-making because it changed the structure of the industry dramatically. Within the space of less than five years, the can-making industry consolidated to a great degree and a few large concerns came to dominate the industry. However, with consolidation came the possibility of higher prices for the American consumer of canned goods. The overriding question was whether the democratic impulse of growing affordability for canned food, in part because of lower prices for tin cans and the growing popularity of the new product, would survive

¹ Arthur Pound, *Industrial America: Its Way of Work and Thought* (Boston: Little, Brown, and Company, 1936), 94-95.

consolidation within the can-making industry.

This chapter addresses three principal questions. First, how and why did the process of consolidation occur, and why did particular firms survive? Second, did the process of consolidation fit Alfred Chandler's model for the type of industry that evolved as big businesses with oligopolistic competition? Finally, did consolidation affect pricing for tin cans and change patterns of technological development? Consolidation occurred early in the twentieth century over a span of just a few years. After consolidation, can-making was effectively bifurcated into those large canners that manufactured their own cans, and the two national can companies producing cans to order for those canners not choosing self-manufacture. Only a few small can-makers continued to exist. The large specialist can-making companies were a duopoly and consisted of American Can Company and Continental Can Company, which, combined, controlled roughly 75 percent of the market for cans. The consolidation and rise of these industry behemoths did not fit Alfred Chandler's model for modern business enterprises, principally because they came to dominance neither because of administrative efficiency nor technological innovation, but through an attempt to monopolize the industry. In their early years, however, American Can in particular, and Continental, to a lesser degree, were constrained by both market forces and government anti-trust decrees. Later in their history, however, American and Continental both exhibited characteristics typical of Chandler's model firm. Post-consolidation prices initially climbed, but low technological and financial barriers to entry induced competitors to enter the market, which quickly

lowered prices. The scope of technological innovation also changed, as incremental innovation, rather than radical, breakthrough innovations, came to characterize the can-making industry.

Alfred Chandler's argument in his seminal work *The Visible Hand* (1977) was that a revolution occurred in the structure and organization of American industry after 1880. According to Chandler, the organization known as the corporation, or in his words "modern business enterprise," replaced market forces in directing economic development in America. He stated that "modern business enterprise took the place of market mechanisms in coordinating the activities of the economy and coordinating its resources. In many sectors of the economy the visible hand of management replaced what Adam Smith referred to as the invisible hand of market forces." Chandler described the modern business enterprise as an entity consisting of "two specific characteristics: it contains many distinct operating units and it is managed by a hierarchy of salaried executives."² According to Chandler, professional managers replaced market forces "where and when new technology and expanded markets permitted a historically unprecedented high volume and speed of materials through the processes of production and distribution," in other words economies of scale. The modern business enterprise was "the institutional response to the rapid pace of technological innovation and increasing consumer demand in the United States during

² Chandler, *The Visible Hand*, 1.

the second half of the nineteenth century."³ He implied that the first companies to capitalize upon new technology, innovative products with mass consumer appeal, or extensive distribution systems were the firms that instituted modern methods of administration, and hence came to dominate economic activity in their respective industries.

There were eight propositions Chandler posited to clarify when and why visible forces were substituted for invisible market mechanisms. The first three explained the initial appearance of modern business enterprise and are central to this study. First, modern corporations replaced traditional forms of organization, such as single proprietorships or partnerships, when "administrative coordination permitted greater productivity, lower costs, and higher profits than coordination by market mechanisms." In other words, as the scale and complexity of an organization's business increased, more sophisticated techniques were needed to control it. Second, the rewards from centralized administrative activities were only achieved when a hierarchy of control was instituted within the corporation. In Chandler's words "the advantages of internalizing the activities of many business units within a single enterprise could not be realized until a managerial hierarchy had been created." Chandler believed that "the existence of a managerial hierarchy is a defining characteristic of the modern business enterprise." Again, the scale and complexity of business activities dictated that more bureaucratic control mechanisms and oversight from a battery of executives. Finally, centralized

³ Ibid., 12.

corporate administration and salaried managers initially appeared in those industries exemplified by new technology and expanding demand. Most of the industries he studied exhibited potential economies of scale through investment in capital intensive technology. Chandler argued that "modern business enterprise appeared for the first time in history when the volume of economic activities reached a level that made administrative control more efficient and more profitable than market coordination."⁴ In summary, professional salaried employees managed an expanded administrative control apparatus in those industries and sectors of the economy characterized by new technology and increasing consumer demand. They changed from traditional forms and structures for business management to modern structures in order to maximize profits, reduce expenses, and quickly respond to changes in customer demand.⁵

Chandler's arguments are insufficient in explaining the organization of the manufacturing industry in the early twentieth century. Specifically, he does not answer how corporations formed through the rampant merger and acquisition mania of the early twentieth century fit his model. Prior to their existence, firms formed through

⁴ Ibid., 6-8.

⁵ Chandler's other five propositions are less central to this project, but elucidated the continued growth of the corporation. He argued that the salaried hierarchy itself became a source of "permanence, power, and continued growth," and the managers within the hierarchy "became increasingly technical and professional." Chandler suggested that long-term stability and future growth were more important to the cadre of professional managers than short-term decisions intended to maximize profits. Over time, managerial capitalism arose and the "management of the enterprise became separated from its ownership." As these large firms grew, they came to dominate economic activity and "altered the basic structure of these sectors and of the economy as a whole." All Chandler's propositions meant to explain and qualify his basic thesis seem plausible, yet they are teleological arguments and cases taken from large, successful, and industry dominant firms that all still existed when he wrote *The Visible Hand* in the 1960s. He took a snapshot of the business landscape in the 1970s, conjectured why these firms were dominant, and then projected his hypotheses backward upon history. Ibid., 8-11.

merger did not invest in new technologies, produce products, or have established distribution systems. They had neither administrative control systems nor a hierarchy of salaried managers. Firms formed through merger may have acquired these features post-merger and introduced innovative technology, but their formation was designed to capture market share and consolidate the industry, first and foremost, in order to maximize profits. Later, these firms rationalized themselves by concentrating production in the most efficient plants to reduce operating costs. This point is crucial for this study because the consolidation of the American can manufacturing industry was the product of mergers that occurred in the early years of the twentieth century.

The American Can Company

The American Can Company was formed in 1901 through the merger of dozens of small can manufacturers and can-making equipment suppliers. The company was fashioned through the efforts of five individuals: William H. (Judge) Moore, his brother J. Hobart Moore, Daniel Gray (Czar) Reid, William B. (Tin Plate) Leeds, and Edwin Norton. The leader of the group was Judge Moore who had gained national fame through his formation of the Diamond Match Corporation and the National Biscuit Company. The Moore brothers, Reid, and Leeds had consolidated several steel companies in 1897 and 1898: National Steel, American Steel Hoop, American Sheet Steel, and the American Tin Plate Company, into a consortium known as the "Moore Interests." These companies were outside the control of J. Pierpont Morgan's Federal Steel and Andrew Carnegie's Carnegie Steel, yet were a significant force in the steel industry. The "Moore Interests"

were the third largest steel holdings in the country and controlled 90 percent of the national production of tin plate. It became known as the "Tin Plate Trust." Judge Moore and his partners sold the "Moore Interests" to Morgan and Carnegie in February 1901, upon the formation of the United States Steel Corporation, and used their new-found wealth to attempt a consolidation of the can manufacturing industry.⁶

In the later part of 1899 Edwin Norton had been retained by the Moore brothers, Reid, and Leeds to purchase the assets of can manufacturing companies. Norton was the only member of the five founders of American Can Company to have any experience in the can-making industry. Norton had envisioned a consolidation of the industry, but it was beyond his financial resources. He readily accepted the offer from Judge Moore to act as his agent, although Moore was known to be "the leading spirit in the new venture" in subsequent court documents. Apparently, Moore and his cohorts believed they could consolidate and monopolize the can manufacturing industry in a similar manner to the tin plate industry, eventually reaping significant financial rewards. Norton was told to "get options" on selected companies and plants with an expiration date of May 1, 1900. The intent was to purchase the plants at a date in the near future. A slump in the stock market caused Moore and his colleagues to let these initial options expire, so they requested Norton to negotiate extending them until January 1, 1901, with some extensions until April 1, 1901. In the first four months of 1901, Moore and his cabal exercised the options and purchased 123 can manufacturing plants or can-

⁶ Unattributed, "The American Can Company," *Fortune Magazine*, Volume II, No. 5 (November 1930): 40.

making machinery companies, almost all acquired "at or within 60 days" of the organization of American Can.⁷

The American Can Company was incorporated on March 20, 1901 with an authorized capital of \$88 million, half preferred stock and the balance common stock. The Moore consortium underwrote the formation of American Can and contributed \$7 million to the coffers of the new firm. They wrote and distributed a subscription agreement to be used in buying plants on which they held purchase options. The authorized capital consisted of \$39 million in common stock and \$39 million in preferred stock, both at a par value of \$100 per share. The preferred stock paid a 7 percent dividend per year. For every \$100 invested by a sponsor or paid for an acquired plant, a subscriber received one share of preferred and one of common. The vast majority of the stock was used to purchase can manufacturing and can-making machinery plants. However, the initial infusion of cash by the Moore group was also used to purchase plants. While most acquired plants were purchased with stock, there was also a small amount of cash used in the purchases. Judge Rose, who presided over the 1913 anti-trust case against American Can, wrote that "the new company [ACC] could not be formed at all unless the larger part of its stock was subscribed for by those whose plants it was to absorb."⁸ The new entity quickly became known to the American public as the "Big Tin Combine," the "Tin Can Trust Perfected," but generically as the "Tin Can Trust"

⁷ *United States v. American Can Company, et. al.*, 230 F. 867, 868, (D. Md. 1916).

⁸ *Ibid*, 230 F. 871-873. The Moore group issued \$23.5 million in stock for the ninety-five plants acquired on March 20, 1901. When combined with their initial cash contribution of \$7 million, they paid \$30.5 million for a company with stock valued at \$39 million - a handsome \$8.5 million return.

or "Can Trust."⁹

The Moore consortium was so committed to controlling the can-making industry that it authorized Norton to pay substantially more than the plants and assets were worth. At the time Norton approached potential acquisition targets, the "Moore Interests" controlled much of the tin plate market, so some can takeover prospects feared a spike in tin plate costs. As such, many independent can manufacturers were "well satisfied to sell to the trust former [Moore], and many another was afraid to remain out by himself."¹⁰ Besides potentially having their tin plate supply interdicted or being slowly squeezed out of business by a larger firm and losing everything, the prices offered by Judge Moore and his cohorts were extremely enticing to targeted companies. According to Judge Rose who later presided over the 1913 anti-trust case against American Can, "the prices paid were liberal, not only to the verge of extravagance, but in cases almost beyond the limits of prodigality. If Norton sometimes showed the can-makers that there was steel in his scabbard, his hands always dropped gold."¹¹ Norton never made, nor was inclined to make, any detailed inspection or valuation of the plants to be purchased. There was little correlation between the price paid for a plant and its value. The prices ranged from 1.5 to 25 times the replacement value of the purchased property. Judge Rose estimated that American Can paid \$23.5 million for the ninety-five plants received the day after its formation, but that they could have purchased land,

⁹ May, *Canning Clan*, 353.

¹⁰ *Fortune*, November, 1930, p. 41.

¹¹ *United States v. American Can Company, et. al.*, 230 F. 870 (D. Md. 1916).

built factories, and equipped these plants with greater capacity machinery "for half, and not improbable that for a third less, of that money," and been better located to meet consumer needs. In one case, a plant was purchased for \$500,000, yet it had cost between \$60,000 to \$70,000 to build and equip the facility. One of the restrictive covenants in the purchase agreements was that sellers agreed not to reenter can manufacturing for a period of fifteen years within a 3,000 mile radius of Chicago -- a geographic domain that effectively covered all the continental United States.¹² American Can continued to acquire can plants in succeeding years. Between 1903 and June 1909, they purchased twelve additional plants, including the Sanitary Can Company.¹³ The exorbitant prices paid for acquisitions, restrictive covenants, and continued pattern of acquisitions were clearly designed actions taken by the founders of American Can to facilitate the elimination of competition and realize their goal of monopolizing can manufacturing.

After its formation, American Can promptly closed a significant number of the initially acquired 123 plants. Their rationale was to eliminate excess capacity, expense, and non-competitive facilities. Unstated was their desire to raise prices for tin cans now that they controlled much of the national market. American Can began shutting plants almost as soon as they took possession of them. By April 21, 1903, just two years after its organization, American Can was operating only thirty-six can plants and three machine shops. It is unclear whether any of the displaced workers from the shuttered

¹² *Ibid.*, 230 F. 871.

¹³ *United States v. American Can Company, et. al.*, 230 F. 888 (D. Md. 1916).

facilities were relocated to other facilities. There were plans stirring to close another five can plants and one or two of the machine shops. In total, American Can closed eighty-four plants within two years of purchase. Many of the plants had been located within a few miles of one another or had obsolete can manufacturing equipment. According to Judge Rose, American Can closed them "because that was by long odds the best thing to do with them. Cans could be made cheaper elsewhere."¹⁴ Rose's acknowledgement begs the question of why American Can would have paid excessive prices for the out-of-date acquired plants. It appears American's intent was to eliminate competition by paying inflated prices for competitors and avoid expense in operating the remaining facilities. William Stolk, the CEO and President of American in 1960, argued the remaining plants were "better equipped" and more "efficiently located throughout the country" than they had been before.¹⁵ Nevertheless, despite Stolk's predilection to cast American's behavior in a rational light, their actions were an extreme form of concentration and elimination. According to a 1930 *Fortune* article, American Can's deeds were "difficult to explain on any basis other than the theory that dead lovers are faithful lovers."¹⁶

Predictably, prices for tin cans increased substantially shortly after the plant closures. The new company was tremendously overcapitalized and had very little working capital. They had few choices but to raise prices. Even Judge Rose agreed that

¹⁴ *Ibid.*, 230 F. 875, 876.

¹⁵ William C. Stolk, "American Can Company: Revolution in Containers," An Address Given in New York City to the Newcomen Society in North America on April 21, 1960 (Princeton: Princeton University Press, 1960), 12.

¹⁶ *Fortune*, November 1930, p. 41.

"prices had to be raised" immediately following the incorporation of American Can.¹⁷ Other sources agreed that American Can had to raise prices to remain in operation. In 1930 *Fortune* magazine argued that the increases in can prices were not intended to "collect any exorbitant profit," but to "keep itself [American Can] in business" because of the significant debt load carried by the new company.¹⁸ American Can began 1901 by increasing prices an astounding 60 percent, then began lowering them in subsequent years. Can prices in 1902 and 1903 were substantially less than 1901, and by 1904 had settled to a point roughly 25 percent higher than what they had been before their incorporation.¹⁹ American Can even raised prices during the midst of the canning season when canners had few choices but to pay the higher prices, or risk losing their crops.²⁰

American Can could increase prices because the new company now controlled roughly 90 percent of the national market for tin cans. Their dominance of the market did not change measurably for the next three years.²¹ Despite Judge Rose's opinion that the company had to raise prices to recoup its investment and *Fortune's* contention that the increased prices were an attempt to stay in business, the near monopolization of tin can manufacturing coupled with increased prices, angered canners and revived

¹⁷ *United States v. American Can Company, et. al.*, 230 F. 879 (D. Md. 1916).

¹⁸ *Fortune*, November 1930, p. 42.

¹⁹ *United States v. American Can Company, et. al.*, 230 F. 880 (D. Md. 1916).

²⁰ Stolk, "American Can Company: Revolution in Containers," 11. The prevailing cost for a #2 can was roughly 2 cents in 1900 and settled to 2.5 cents in the period 1901-1904.

²¹ James W. McKie, *Tin Cans and Tin Plate: A Study of Competition in Two Related Markets* (Cambridge: Harvard University Press, 1959), 86; Stolk, "American Can Company: Revolution in Containers," 11.

competition.

Between 1901 and 1904, there were many new entrants into the can manufacturing industry. The higher prices for tin cans now made it a profitable business venture as the capital requirements for a new participant were relatively minimal. According to *Fortune* there was a "wild rush" to get into can manufacturing, and "it seemed everyone was making tin cans."²² The machinery available to the new ventures may not have been the most modern, as American Can controlled the vast majority of can-making machinery concerns, but "they [new firms] could after 1902 obtain far better machines than were accessible to them in 1901," as American sold much of the older equipment to raise cash. Many of the new firms were undercapitalized operations that provided poor quality cans, yet some were legitimate competitors.²³ American Can attempted to retain its dominant market position by purchasing several of the new companies and buying excess cans from competitors, but the high prices kept some small firms in business. American Can had little money available to continue acquiring new companies, so their initial policy to buy them all soon became untenable.

The prudent action was to lower prices. As American Can began to lower can prices in steps from 1901 to 1904, many of the new companies exited the can manufacturing business as it was no longer the profitable venture they had imagined. According to Judge Rose, the vast majority "of the people who in 1901 rushed into can making were forced out of business, so soon as prices came down from the abnormal

²² *Fortune*, November 1930, p. 42.

²³ *United States v. American Can Company, et. al.*, 230 F. 879, 880 (D. Md. 1916).

heights to which they had been lifted."²⁴ After 1904, the threat that new can manufacturing companies had limited access to machinery or tin plate were no longer valid concerns. These were issues which had prompted many firms to sell to American Can before its formation in 1901. American Can did not control tin plate manufacturing, the dominant firm was United States Steel, and there were other can equipment machinery manufacturers. Thereafter, prices for tin cans stabilized as many of the post-1904 competitors remained in business. American's attempt to capitalize upon its dominant market position by raising prices ended in 1904. By this time, American Can "had definitely abandoned the policy of charging prices which to the consumer seemed unduly high."²⁵

The net result of American Can's plant closures and predatory pricing practices from 1901 to 1904 was that their market share shrank considerably. From 1901 to 1913, the market share of American Can fell from a height of 90 percent in 1901, immediately after incorporation, to roughly 50 percent by 1913. They were still the industry leader and largest manufacturer of cans in America.²⁶ By 1913, one-third of all tin cans in the United States were made by American Can, one-third by their competitors, and one-third manufactured by canning firms for their own use.²⁷ The decline in American's share was principally the result of revived competition from some of the more robust competitors that had entered the market after 1901 and survived.

²⁴ *Ibid.*, 230 F. 880 (D. Md. 1916).

²⁵ *Ibid.*, 230 F. 893 (D. Md. 1916).

²⁶ McKie, *Tin Cans and Tin Plate*, 86.

²⁷ *United States v. American Can Company, et. al.*, 230 F. 898 (D. Md. 1916).

The aggregate growth rate in these years for American's competitors was greater than that of American. Judge Rose stated "their [American's competitors] growth has usually been higher than that of the defendant [American Can], sometimes much higher."²⁸

The case of American Can's reduced market share is indicative of two market mechanisms. First, as prices increased, more competitors entered the market, thereby increasing the aggregate supply of cans. As the supply of cans increased, the prices for cans decreased. Some of the cans which had formerly been manufactured by American Can were now made by competitors. Second, the relative stability of can prices after 1904 indicates that that market equilibrium had been reached. Supply matched demand, and prices remained stable from 1904 through 1913. American Can was still the largest can manufacturer in the country, but their desire to arbitrarily dictate can prices had diminished. Judge Rose agreed when he stated that a "considerable rise in can prices," unless because of increased costs of production or raw materials, would result in two phenomena. First, self-manufacturers would begin to manufacture for other customers and, second, current buyers of cans from specialist can companies would enter self-manufacture. Neither of these cases occurred from 1904 through 1913. Rose's conclusion was that "such a possibility imposes a check of no mean efficiency upon the actual power of the defendant [American Can] greatly to raise the price of cans."²⁹ However, American was the pricing leader as they acquired a competitive advantage as the first institution to consolidate the can manufacturing

²⁸ Ibid.

²⁹ *United States v. American Can Company, et. al.*, 230 F. 899, 900 (D. Md. 1916).

industry. Unquestionably, the business practices of American Can were constrained by traditional market forces.

As mentioned above, the early business practices of the American Can Company led to a federal anti-trust case. The United States Attorney General filed suit against the American Can Company under the Sherman Anti-Trust Act of 1890 in the District Court of Maryland, seated in the canning center of Baltimore, on November 29, 1913. The prosecutor was John P. Hill, the United States Attorney for the District of Maryland. In his *Original Petition* to the court, Hill preferred charges against the American Can Company, the Sanitary Can Company, the Max Ams Machine Company, several smaller can companies, and key individuals such as William and J. Hobart Moore, Daniel Reid, William Bogle, George Cobb, and Charles Ams. All told, there were thirty-six corporate or individual defendants. The case became known as *United States v. American Can Company, et. al.* The case, in general, alleged the defendants had conspired together to monopolize the trade in tin cans. The specific charge was "restraining interstate and foreign trade and commerce in tin cans and are attempting to monopolize and are monopolizing the same in violation of the Act of Congress of July 2, 1890." The object of the legal action was "to prevent them from further restraining, monopolizing, or attempting to monopolize such trade and commerce."³⁰ The *Original Petition* then detailed the activities of each corporation or position of the individual defendants, provided an overview of the industry, and finally described the "formation of the

³⁰ *United States v. American Can Company, et. al.*, Original Petition, 2, 3 (D. Md. 1913).

conspiracy" and creation of the investor group led by the Moore brothers.

The section entitled "Acts in Furtherance of the Conspiracy" detailed specific charges. This section delineated actions such as the acquisition of competitive can-making plants, restrictive covenants in the purchase agreements, procurement of major can-making machinery companies, dismantling of many of the plants, a preferential contract for tin plate with American Sheet & Tin Plate Company, and "unfair business practices." Among the latter category, American was accused of having "increased the general market prices of tin cans," and that "acquired such degree of control of the trade in the open-top or so-called sanitary cans . . . it is able to fix, and does fix, higher prices for such cans than for others." Other unfair practices were that American Can had "induced or compelled" customers into exclusive long term supply contracts, obfuscated the fact they owned companies believed to be independent of them, and "many other acts" in furtherance of their conspiracy.³¹

The *Original Petition* sought eleven specific solutions or remedies in the "Prayers" section. The most notable were to find American Can, the "principal defendant," and the other defendants guilty of monopolization and restraint of trade, elimination of the restrictive covenants on potential competitors, annulment of long term contracts as a condition of doing business, and the dissolution of American Can Company. The dismemberment of American Can was the most significant action requested by the government of the Court. The specific request was that American Can

³¹ Ibid., *Original Petition*, 19, 20 (D. Md. 1913).

"be enjoined from shipping or selling any of its products . . . until it shall have been dissolved into such number of separate and independent units of different ownership." It was believed such a drastic action was "necessary to restore competitive conditions in the manufacture, shipment, and sale of tin cans."³² The case was a potential death sentence for American Can.

Initial reaction from American Can was swift and forceful. The same day the charges were preferred, the president of American Can, Fred S. Wheeler, said in the *New York Times* that the case would be "defended vigorously and confidently" and there was no cause for "alarm as to the outcome." He claimed that "neither in the origin of the company nor in the subsequent conduct of the business had monopoly or restraint of trade been attempted or attained." Wheeler argued that none of the unfair practices in the suit had been employed by the company, and he contested the existence of any arrangements to control prices or obtain tin plate at preferential rates. He denied that American Can "sought in any way to rule or dominate the industry" and believed that competition was "wholly free and active" in the can manufacturing industry. He acknowledged that American Can sought to expand its business, but it would do so not by "futile attempts to monopolize or dominate the trade," but by seeking "the very best methods of efficient organization, of manufacture, and of distribution to meet better than others all the rightful needs of those who use its

³² Ibid., Original Petition, 22 (D. Md. 1913).

products."³³ Alfred Chandler could not have written a better statement of corporate intent.

The case progressed slowly over the next two years. The number of defendants in the *Original Petition* was thirty-six, but the court dismissed charges against all but five of the corporations and eight of the individuals. The defendants, principally American Can, had placed 516 witnesses on the stand, the government 346. Between 1,500 and 1,600 exhibits were reviewed, and the court record covered more than 8,700 pages of testimony.³⁴ The government presented evidence and testimony that American Can had bought tin plate at preferential prices and unnecessarily dismantled plants. On the subject of dismantling plants, Judge Rose saw no nefarious purpose and concluded simply that "cans could be made cheaper elsewhere."³⁵ The government offered data on the questions of why American Can had been formed, raised prices during the canning season, and forced customers into long term supply contracts. Judge Rose found that testimony from "probably a hundred or more witnesses," that American Can refused to sell to customers with whom they did not have a long term supply contract was "disproved," and without merit.³⁶ The allegation of unfair acquisition of can plants at formation was similarly dismissed by Judge Rose. He found the charge was baseless because the owners of these companies had initially approached American Can. This finding effectively voided charges pertaining to American's purchase of the Sanitary Can

³³ *New York Times*, November 30, 1913, p.

³⁴ *United States v. American Can, et. al.*, 230 F. 860 (D. Md. 1916).

³⁵ *Ibid.*, 230 F. 876 (D. Md. 1916).

³⁶ *Ibid.*, 230 F. 884 (D. Md. 1916).

Company and consequent dominance of the market for sanitary cans.³⁷ Finally, despite the government's presentation of evidence on the issue of price fixing, Rose concluded that there was no collusion amongst competitors, nor was it any longer possible for American Can to "arbitrarily" fix prices. This was because of "competition to which the defendant is exposed."³⁸

Much of the evidence presented by American Can was designed to show how the company had met the needs of their customers and served the industry, as a whole, very well. American claimed they had led the drive to standardize can sizes, manufactured a superior product thereby forcing competitors to do the same, promoted scientific study of canning problems, and agreed to supply all cans required by canners during the packing season rather than supplying only a specified quantity, as had been standard practice. Other services offered by American Can that were novel to the industry were prompt deliveries, storage arrangements for excess customer cans, and the generation of a "good feeling in the trade."³⁹ These tidings of joyous feelings were primarily because of lowered can prices from 1901 to 1913, for which American Can attempted to take credit. Judge Rose found, however, that the lowered prices were primarily because of "almost entirely . . . cheaper tin plate," yet American Can remained "unmistakably popular in the trade."⁴⁰ One example of American's popularity within the can manufacturing industry was the company's reaction to the 1906 San Francisco

³⁷ Ibid., 230 F. 887-891 (D. Md. 1916).

³⁸ Ibid., 230 F. 892 (D. Md. 1916).

³⁹ Ibid., 230 F. 894-898 (D. Md. 1916).

⁴⁰ Ibid., 230 F. 898 (D. Md. 1916).

Earthquake. All of American Can's plants in the San Francisco area had been "knocked out." Because the fruit crop was already maturing, to meet the needs of their customers American shipped 4,700 railroad cars of cans "over the Rockies, at a considerable cost to its 1906 income," as well as extending substantial "emergency credits." These magnanimous actions on the part of American Can ensured "no West Coast canner suffered that year for lack of cans," enhancing its national reputation.⁴¹

Judge Rose offered his decision in the case on February 22, 1916, finding that two interrelated points had been proved over the course of two years, after all the presentations of witnesses, exhibits, and documents by both the government and defendants. First, the government had proved the case that the American Can Company had been formed to monopolize the manufacture of tins cans and had engaged in restrictive trade practices in its early years. Rose stated unequivocally "that the defendant was organized to monopolize interstate trade in cans, and to attain that object such trade was unlawfully restrained by it, and by those who formed it and directed its earlier activities." Second, while the genesis of American Can was for anti-competitive purposes and duplicitous means had been utilized to monopolize the industry, these circumstances were in the past. Rose's opinion was "that for some time before the filing of the petition in this case, it has done nothing of which any competitor or any consumer of cans complains, or anything which strikes a disinterested outsider as

⁴¹ Stolk, "American Can Company: Revolution in Containers," 12.

unfair or unethical."⁴² Judge Rose's conclusions were a split decision -- American Can had been formed to monopolize can manufacturing and engaged in restraint of trade, but these unlawful acts were in the past. They were now a company with a very positive reputation.

In his decision, Rose acknowledged American Can exerted significant power because of its considerable size within the industry, but these facts must be balanced against the "public weal."⁴³ According to Rose, "time has gone by," conditions within the industry had changed, and "it is absolutely impossible to put things back to where they were on the 1st of March, 1901." He was "frankly reluctant to destroy so finely adjusted an industrial machine as the record shows the defendant to be." Rose's decision was to find the American Can Company guilty of violating the Sherman Anti-Trust Act, yet hold dismemberment of the company in abeyance because such an action would not be in the best interest of the public. He stated that it would "be better to retain the bill, without at present decreeing dissolution, but reserving the right to do so whenever, if ever . . . the size and power of the defendant . . . are being used to the injury of the public."⁴⁴ A subsequent petition filed by the Department of Justice on July 7, 1916 moved for a decree of dissolution, while American Can countered with a motion for dismissal of the case. Judge Rose believed that either outcome would result in multiple appeals and cost all parties much time and money. He let his prior decision stand and

⁴² *United States v. American Can Company, et. al.*, 230 F. 861 (D. Md. 1916).

⁴³ *Ibid.*, 230 F. 901 (D. Md. 1916).

⁴⁴ *Ibid.*, 230 F. 903, 904 (D. Md. 1916).

denied the petitions of both parties. The final judgment was that "while the defendant was organized to monopolize interstate trade in cans," the size and power of American Can was not presently being used to monopolize the can manufacturing industry. However, if the size and power of American Can in the future was used to harm the public, his decision was subject to a "renewal of such demand [dissolution] or the seeking of appropriate remedy . . . whenever such size and power . . . have given the defendant dominance and control over the industry . . . as to make dissolution or other restraining decree of the court expedient."⁴⁵ American Can now had another constraint, besides market forces, to restrict its future business practices -- the threat of government intervention, oversight of its management practices, and potential dissolution of the company. This constraint, one held in perpetuity, was a key factor pertinent to any subsequent growth of American Can.

The 1916 decision in *United States v. American Can Company* not only constrained the future business practices of the company, it also created an aura of reticence within the firm. In 1941, *Fortune* magazine reported that American Can was still "sensitive on the subject of its own origin." They described a peculiar company culture where employees "point with something oddly akin to pride to the fact that its own share of the can industry's business has shrunk to a little more than half -- about 51 per cent."⁴⁶ The misgivings on the genesis of the company extended into the 1960s.

⁴⁵ *United States v. American Can Company, et. al.*, 234 F. 1019-1022 (D. Md. 1916).

⁴⁶ Unattributed, "American Can Company," *Fortune Magazine*, Volume XXIII, No. 1 (January 1941): 54.

William Stolk, the CEO and President of American Can in 1960, stated that "it is only fair to judge our predecessors by the ethics of their day, not ours. Such an approach to the world of competition has long since been proved unworkable and would be unthinkable today."⁴⁷ He continued on the subject of competition and said the company had not "made any effort since our first year to block competition."⁴⁸ Belatedly, this was an admission by a senior executive of the American Can Company that they had originally been formed with the intent to monopolize the can manufacturing industry, a conclusion reached much earlier by the public, journalists, and the federal government. Stolk also acknowledged that even in 1960, American Can was "still subject to that decree," meaning the 1916 decision of Judge Rose.⁴⁹ The federal courts had effectively placed a limitation and constraint upon the conduct of business at American Can.

Nevertheless, the formation of the American Can Company forever changed the landscape of can manufacturing in America. They became one component of a duopoly that came to direct and dictate the pace of change within can manufacturing for most of the twentieth century. Despite a position some might view as anti-competitive, the company was held in high regard within the business community. The 1941 comment in *Fortune* magazine cited in the opening of the chapter is a testament to how the company was viewed by the business community. The comments by *Fortune* were

⁴⁷ Stolk, "American Can Company: Revolution in Containers," 11.

⁴⁸ *Ibid.*, 15.

⁴⁹ *Ibid.*, 16.

somewhat hyperbolic, but the impress of American Can on tin can manufacturing, regardless of their questionable origins, were substantial.

The Continental Can Company

The Continental Can Company was formed in 1904 as a direct result of the rapid monopolization of the national can manufacturing industry by American Can. They were not a party to the 1913 suit against American Can. Continental had immediate success and a "solid start" in can manufacturing because several senior executives "defected" from American and brought with them the business of Campbell Soup Company, at the time the largest consumer of tin cans in the world.⁵⁰ Although American Can had increased the price of tin cans and initially controlled nearly 90 percent of the market, the technology of can-making was neither proprietary nor controlled by American, so there was space within the industry for a well-organized competitor. Continental Can was clearly, according to *Fortune*, "part of the rebound against American."⁵¹ The inception of Continental Can began in 1902 when Edwin Norton resigned from American on account of poor health. After quickly recovering from his illness, Norton was "not content with relative inactivity" and believed that there was "an opportunity for an independent can company" on account of American Can's market dominance and pricing practices.⁵² In 1904 Norton, in combination with Thomas Cranwell, his son Arthur W. Norton, Frederick Assman, and with investor capital

⁵⁰ McKie, *Tin Cans and Tin Plate*, 89.

⁵¹ *Fortune*, April 1934, p. 80.

⁵² May, *Canning Clan*, 353-354.

of \$500,000, founded Continental Can in Baltimore. Both the Nortons, Cranwell, and Assman were former American Can employees, Cranwell having been responsible for the Campbell's account while there. Initial purchases were the United Machinery Company of Rochester, New York, and can plants in Chicago and Syracuse, plus interests in a railroad. A few years later Continental purchased a third plant in Baltimore and in 1909 bought Standard Tin Plate of Canonsburg, Pennsylvania, one of the few tinplate manufacturers independent of United States Steel. After those early acquisitions, Continental began making sanitary cans and focused on manufacturing food cans, but also made a significant quantity of "general line" cans, for non-food, non-perishable items. By 1919, Continental was the second largest can manufacturer in America, but its sales were only one-fourth of the industry leader.⁵³ The primary plant in their constellation of sites was the facility in Clearing, Illinois, located on the Southside of Chicago. This plant, at the time of its construction in June 1917, was the largest can manufacturing facility in the world. The plant consisted of six buildings and occupied 202,860 square feet of land, with total floor space of 502,860 square feet. The six buildings were for administration, manufacturing, warehousing, and wooden crate manufacturing. There was also a train shed for transporting finished cans and a "powerhouse" for providing steam power for the complex. The can manufacturing building was a four-story structure with floor space of 230,400 square feet, sufficient for

⁵³ Pound, *Industrial America*, 98-99; McKie, *Tin Cans and Tin Plate*, 89.

daily output of two million cans.⁵⁴

The 1920s was the decade that elevated Continental to be a serious competitor of American Can and to the solid position as the co-leader of the can manufacturing industry. Continental nearly doubled its number of plants and production capacity during that decade, and the key figure behind the growth was Carle Cotter Conway. Conway joined Continental in its early years and had married Edwin Norton's daughter Sylvia, thereby cementing his relationship with America's most renowned can-maker. Conway was appointed a vice president in 1923 and in 1926 became president. One of his first acts as president was expansion to California in 1926 and Seattle in 1927 by purchasing several small firms. Continental now had a coast-to-coast business footprint. In Seattle, Continental pioneered a new process for manufacturing salmon cans headed for Alaska. The cans were flattened before they were shipped, to conserve space, then reformed upon arrival at their filling location. In 1928 Continental purchased the United States Can Company of Cincinnati. The U. S. Can Company acquisition was Conway's crowning achievement. This company had factories in Cincinnati, Baltimore, East St. Louis, Illinois, Roanoke, Virginia, and Chicago. The former owner of U. S. Can, Oscar Huffman, was well known throughout the can manufacturing industry, and he became a roving ambassador and the principal negotiator for subsequent purchases of can-making companies for Continental. In 1928 and 1929 Huffman engineered the purchase of fifteen more facilities for Continental, including machinery manufacturers McDonald

⁵⁴ Davidson and Weiss, Architects, "Manufacturing Plant of the Continental Can Company, Inc., Clearing, Ill.," *The American Architect*, February 27, 1918: 253-255.

Machine Company, which specialized in presses and air testers, and Troyer-Fox Company, which manufactured other can-making equipment.⁵⁵ During the Conway years, Continental grew through acquisition rather than by building new sites. Through Conway's imagination, vision, and actions, Continental had doubled in size by 1929 from investing over \$20 million in smaller can manufacturers.⁵⁶ They now had a national network of not only can manufacturing plants, but can-making machinery facilities as well.

By the early 1930s, Continental Can operated thirty-two modern and highly efficient can plants. Twelve of these plants made food cans, fifteen manufactured a variety of general line containers, such as motor oil, and five plants designed and built machinery. It was as fully integrated as American Can. The food can factories were spread throughout the United States and tended "toward locations near the growing or producing areas suitable for quantity packs" in order to minimize transportation costs for shipping cans.⁵⁷ Nearly 70 percent of Continental's business, in terms of gross sales, were food cans, the remainder general line containers. In 1934 Continental manufactured approximately 1.75 billion food cans, 30 percent of which went to the Campbell Soup Company.⁵⁸ By the mid-1930s, Continental Can and American Can controlled about 75 percent of the national market for food cans, Continental being half the size of American. The size of the national market for all types of food cans - fruit,

⁵⁵ *Fortune*, April 1934, p. 81-84; Pound, *Industrial America*, 99-101.

⁵⁶ McKie, *Tin Cans and Tin Plate*, 90.

⁵⁷ Pound, *Industrial America*, 96.

⁵⁸ *Fortune*, April 1934, p. 134.

vegetable, meat, seafood, milk, and soup - made by specialist can manufacturing companies was around seven billion cans annually. The average price for a standard #2 tin can was three cents and American and Continental were the pricing leaders. The competition between them dictated the relatively stable and affordable market price for tin cans.⁵⁹

Continental was, like American, a product of merger and acquisition, yet it was not included in the 1913 anti-trust case against the industry, principally American Can. This was because Continental was a competitor for American Can, having entered the market because of American's exorbitant pricing policies. Their objective was to take market share from American by reducing prices and supplying former American customers. At its founding, Continental was very fortunate to have a cadre of knowledgeable industry experts and insiders to lead the company. Additionally and most importantly, what Continental did have was the largest customer for tin cans in the world, the Campbell Soup Company, around which to build their business. Absent such a large customer, the history of Continental may well have been the same as other small firms entering the can-making industry in response to American Can's business practices of the early 1900s. The later success of Continental Can came from geographic expansion and the development of new forms of metal packaging.

⁵⁹ Ibid., p. 77. The estimated national market of seven billion cans was derived from Continental's known sales of 1.75 billion cans and market share of twenty-five percent.

Basis of Competition

The history of American Can and Continental Can in the 1920s and 1930s demonstrated a pattern of industry dominance based upon research, machinery improvement, and new product development. For most of the twentieth century, these two companies controlled nearly 75 percent of the market for tin cans in the United States.⁶⁰ In the 1910s, American Can used its size and financial resources to establish research and development laboratories. Two of their first projects were research on differentially coated tin plate and an improved interior enamel to use on corn and other products that discolored when canned. The differential tin plate had a thicker coating of tin on the interior of the can and was used to prevent leakage of highly acidic products that often created perforations in the can. In 1921, in conjunction with the National Canners Association, American developed a product known as "C-Enamel." This product was coated on the interior of cans and prevented the formation of "corn black," brown or black specks formed when sulfur gas emitted by the canned corn mixed with the iron oxides from the tin-coated steel. The solution was to add a small amount of zinc oxide into the waxes, gums, and other products used for the interior lining. This new material, "C-Enamel," quickly became the preferred interior enamel used throughout the industry, and was licensed by American to be made by enamel suppliers and sold throughout the industry. It was later used to prevent discoloration of other highly

⁶⁰ May, *Canning Clan*, 356; McKie, *Tin Cans and Tin Plate*, 84, 86, 89.

pigmented vegetables, such as cherries and beets.⁶¹ The chief chemist who developed "C-Enamel" at American Can, Herbert Baker, said in a 1923 address on the future of the tin can to the New York Wholesale Grocers Association that "C-Enamel" was "ideal" and "eminently satisfactory" for packing corn. It was also "excellently adapted" for most other fruit and vegetable products.⁶² Continental Can also had research facilities similar to American Can. They had a staff of chemists located in Chicago who studied enamels, lacquers, tin coatings, and new packaging protocols for specialty products. Continental also had a metallurgical laboratory located in Pennsylvania. The staff chemists and metallurgical laboratory assisted customers in solving problems such as can failure analysis, designing more efficient plant layouts, "trouble-shooting" can closing issues, and developing new containers for new customer products. By the 1930s, the research and development activities and capabilities of American Can and Continental Can were quite similar.⁶³

American Can and Continental Can both operated machine shops to develop improved can manufacturing equipment. There were no breakthrough pieces of machinery developed from the 1910s through the 1930s, but every piece of equipment experienced some sort of incremental improvement. Slitters, body makers, soldering apparatus, flangers, seamers, and air testers were made to run faster in order to increase throughput on the line. A standard can line at a food can plant, at either

⁶¹ May, *Canning Clan*, 261-264.

⁶² Herbert A. Baker, "Status of the Tin Can in the Canned Foods Industry," An Address Given in New York City to the New York Wholesale Grocers Association on February 13, 1923 (New York: American Can Company, 1923), 11-28.

⁶³ Pound, *Industrial America*, 102; McKie, *Tin Cans and Tin Plate*, 91.

company, ran in excess of 300 cans per minute by the early 1930s. American operated five or more machine shops during this period, while Continental made several significant acquisitions in the 1920s to achieve a position where there was "little difference between American and Continental in machinery and machinery service" by the mid-1930s.⁶⁴

In the 1930s, American and Continental developed two extremely important new products. The first of these was a can for motor oil. Developed by Continental Can in 1933, the motor oil can gained rapid acceptance with the public. Prior to the quart oil can, motor oil was dispensed from large bulk containers into small oil cans with spouts. The customer was assured of neither the brand of oil, nor the amount consumed. The motor oil can alleviated both these potential areas for fraud. Production of a quart oil can was not much different from a fruit or vegetable can, so Continental did not have to make any significant change in their manufacturing protocols. By 1934, Continental sold 350 million quart motor oil cans which represented nearly 20 percent of the general line cans they produced. Customers now received the grade, quantity, and brand they desired, while the dealer had better controls on his inventory.⁶⁵

The second major product development of the 1930s was the beer can. While developed almost simultaneously by both American and Continental, most of the credit is attributable to American. According to former American Can CEO William Stolk, "one of our proudest achievements in the 1930s was the beer can. It took a lot of

⁶⁴ Pound, *Industrial America*, 102; McKie, *Tin Cans and Tin Plate*, 88, 90-91.

⁶⁵ Pound, *Industrial America*, 104-105.

imagination, hard work, time and dollars. And it made money for us." The key technological hurdles were determining how to hold a pressurized product in a can, selecting the proper linings so that the taste of the beer was not compromised, and removing oxygen from a container for a carbonated beverage infused with carbon dioxide.⁶⁶ American was confident enough to test market the product in January 1935 near Richmond, Virginia and began general distribution in September 1935. American offered a "flat-top" beer can, while Continental manufactured a "cone-top" that was similar to a glass beer bottle. The beer can was convenient for consumers because they did not have to return them, as they did glass bottles, nor pay a deposit. Compared to glass bottles, beer cans required less shipping space, were more durable, allowed no light penetration to spoil the beer, and they were easier to carry.⁶⁷ The American-style "flat-top" eventually became the industry standard, so Continental later changed to this style too. A survey by *Fortune* magazine in late 1935, only a few months after general distribution of the beer can, found that a majority of the people who had tried canned beer preferred it to bottled beer 44 to 34 percent. From this data, *Fortune* concluded that "at least half the people could be taught to take their home beer that way [in a can]."⁶⁸ This would prove to be a gross understatement as canned beverages gained immediate acceptance with consumers.

The basis of competition between American Can, Continental Can, and the rest

⁶⁶ Stolk, *American Can Company: Revolution in Containers*, 18-19.

⁶⁷ Unattributed, "Beer Into Cans," *Fortune Magazine*, Volume XIII, No. 1 (January 1936): 76-78.

⁶⁸ *Ibid*, 157.

of the industry did not rest upon pricing, but providing superior quality, service, and research to their customers. Price was not the main point of competitive advantage for either national firm. John Baldwin, a senior sales manager, who began his thirty-nine year career at Continental Can in 1920, claimed that both American and Continental did not sell on price. Baldwin said "as a matter of fact, we have maintained about the same price. We knew that we couldn't get any more for our cans than the American Can Company, and, of course, when they came out with a price change, we weren't far behind in finding out what it was because our customers would let us know immediately." Competitive information on pricing was never exchanged between the competitors, according to Baldwin, rather reciprocity in pricing was the convention. According to Baldwin, "it wouldn't be long before we had it [price information], and when we changed them, why, it was vice versa."⁶⁹ In a similar vein, Clarence Smith, a salesman for Continental Can in the 1920s and 1930s, agreed that pricing was not the basis of competition because it was too ephemeral. Smith said "particularly with the major items like fruit and vegetable cans, you never have a price advantage . . . you are never able to maintain it longer than a few minutes to a couple of days." The tendency was for prices to decline, and Smith observed "the buyer or the other buyers want the same advantage. So your competition must meet you, or vice versa."⁷⁰

American Can Company employees held the same beliefs regarding the basis of

⁶⁹ "John E. Baldwin Oral History Manuscript," interview by Edward F. Keuchel, 15-16 April, 1964, New York State Food Processing Industry Oral History Project, Archive #2378, Transcript # 1220, 10-11.

⁷⁰ "Clarence W. "Bill" Smith Oral History Manuscript," interview by Edward F. Keuchel, 17 April, 1964, New York State Food Processing Industry Oral History Project, Archive #2378, Transcript #1231, 33.

competition between the industry behemoths. Martin Corcoran began working for American Can in the 1920s and rose to become the customer service manager for New York, Pennsylvania, and parts of Ohio and West Virginia. He supported his competitor's Baldwin and Smith's claims regarding pricing when he said "most containers are within a penny a thousand." Corcoran believed service was the only method to differentiate yourself from the competition and stated "we feel it [differentiation] is only service, only the type of service and having deliveries prompt, having containers available, . . . having help available to him [the customer] in a matter of minutes or hours at the most, and, . . . somebody he can rely on every minute of the day or night during his packing season. I say you only build up loyalty in the customer by service."⁷¹

Customers believed there was little difference between American Can and Continental Can. Howard Cumming was the owner of a New York cannery in the 1920s, the Good Luck Food Company which made pie fillings and baby food. Regarding the consolidation of the can manufacturing industry he said "cans were alike whether they came from American or Continental. And so I think, that in a way they preserved a lot of canners. A lot of canners couldn't have lived without them." Besides offering "very flexible credit," Cumming thought the research capabilities of both American and Continental were extremely important. He stated "they had a lot of effect and favorable effect because they did a great deal of research work. Most canners had very little capacity to do research work for themselves . . . they made a great contribution that

⁷¹ "Martin H. Corcoran Oral History Manuscript," interview by Dr. George Hucker, 3 June, 1964, New York State Food Processing Industry Oral History Project, Archive #2378, Transcript #1215, 19-20.

way. There's no question about that." Cumming commented on pricing when he claimed American and Continental competed with one another in making "liberal settlements" with customers for defective tin cans. According to Cumming, "they found many ways to subsidize people they wanted to."⁷²

Middle Tier Can Manufacturers

Even though American Can and Continental Can dominated the can manufacturing industry and sold nearly 75 percent of all fruit and vegetable cans in the country by the late 1920s, a significant number of cans were produced by "middle tier" firms.⁷³ There were four "middle tier" firms that specialized in manufacturing food cans, also known as "packers cans." The largest of these firms was the National Can Company. National traced its origin to 1899 and began operations as the John Boyle Company of Baltimore, a firm which made cans, packed food, and sold excess cans to other canners. In 1909 the John Boyle Company was purchased by the Metal Package Company of New York and changed their name in 1918 to the Metal Package Corporation. Subsequent purchases in the early 1930s of Fisher Can of Ohio, and Boston-based Colonial Can and National Can, completed the early acquisitions of the firm. Most importantly, the name was changed to National Can in 1935 in order to stress their presence in Chicago, Baltimore, Boston, Ohio, and New York. Despite this expansion, the company was still a distant third in the manufacture of food cans in the

⁷² "Howard T. Cumming Oral History Manuscript," interview by Dr. George Hucker, 28 February, 1964, New York State Food Processing Industry Oral History Project, Archive #2378, Transcript #1213, 62-65.

⁷³ McKie, *Tin Cans and Tin Plate*, 84.

1930s.⁷⁴ The fortunes of National Can improved in the 1930s with the hiring of Robert S. Solinsky. Solinsky began his career in can manufacturing as a messenger boy for American Can at their Maywood, Illinois plant in 1908 and spent twenty-four years in the sales organization of Continental Can from 1911 to 1935. After joining National Can in the 1930s, Solinsky eventually became President and CEO of National in 1952 and remained in this position until his retirement in 1966. During his tenure, Solinsky built National Can into a rival of American and Continental through the acquisition of additional beverage, food, and general line can manufacturing operations national wide. Although National's footprint was significantly smaller than their larger competitors, they were clearly the third largest player in the market⁷⁵

Fruit packing in California generated opportunities for American Can and Continental Can, and, additionally, led to the formation of a regional competitor. American and Continental both had operations on the West Coast in the first decade of the twentieth century. In 1907, American signed a contract with the California Fruit Canners' Association (CFCA) to provide 300 million cans over the course of five years. American manufactured these cans at their plant in Pittsburg, California, an industrial area in the East Bay area of San Francisco Bay. At the time this was the "biggest contract ever awarded for tin cans" and a sign of the growing importance of the Golden State to the can manufacturing industry. American Can had told the CFCA they could

⁷⁴ Robert Stuart, "The National Can Story: In An Historic Industry, An Historic Company Organized for the Future," An Address Given in Chicago, Illinois to the Newcomen Society in North America on April 19, 1971 (Princeton: Princeton University Press, 1971), 12-13.

⁷⁵ Richard C. Bjorkland, *R. S. Solinsky: Dean of the Can Industry* (Chicago: National Can Company, 1969), 95-99.

not lower the price further on even this large an order because of the high prices they were paying for tin plate. As a result, the CFCA threatened the American Sheet and Tin Plate Company that they would backward integrate and build their own steel plant. The prices for the tin plate were eventually lowered, as it was a small step for CFCA into self-manufacture if they manufactured their own tin plate.⁷⁶

The large volume in California eventually led to the formation of a regional can company, Pacific Can. The growing market provided room for everyone. Founded in 1927 and concentrating solely on "packers cans" for the fruit and vegetable industry of California, Pacific Can grew rapidly in the 1930s and 1940s increasing its volume eightfold between 1939 and 1954. It also manufactured a line of can-making machinery for their own use, and became a "formidable rival" for both American Can and Continental Can on the West Coast.⁷⁷ Pacific Can and their four plants were purchased by National Can in 1955. This acquisition made National Can "truly a third national can company."⁷⁸

The final two "middle tier" can manufacturing companies were Crown Cork & Seal Company of Philadelphia and Heekin Can of Cincinnati. Crown had a long established history as the preeminent maker of bottle caps, known in the industry vernacular as crowns, in the late nineteenth and early twentieth centuries. In the 1930s they feared that the newly developed beer can would displace glass bottles and the

⁷⁶ *New York Times*, 23 December 1907, p. 8.

⁷⁷ McKie, *Tin Cans and Tin Plate*, 94.

⁷⁸ Stuart, "The National Can Story," 18-19.

need for their primary product, so they sought to diversify and manufacture packers cans. In 1936 they purchased the Acme Can Company and formed the Crown Can Company. In 1937 they constructed in Philadelphia the then largest can manufacturing plant in the world. Further expansion and acquisition activity provided Crown a national footprint with operations in Chicago, Florida, Indiana and Nebraska by the early 1940s, but they remained a small actor in the food can industry.⁷⁹ Heekin Can was founded in 1901 in Cincinnati to service regional customers in the Ohio and Mississippi River Valleys. Focusing on packers cans for primarily vegetable canners in these regions and being a closely-held private firm, Heekin remained a viable independent firm until the 1990s. The firm operated four facilities in Ohio, Tennessee, and Arkansas and was a major force within their chosen region, yet remained a minor player in the national market.⁸⁰

Effects of Consolidation

The can manufacturing industry was very concentrated by the late 1930s. Much of the reason for this was the dominance of American Can and Continental Can and their financial resources to purchase or manufacture the most modern can-making equipment. While the industry behemoths established the major trends within the industry in terms of pricing and technology, there was still a large enough market for firms with a regional orientation to survive. The availability of tin cans at reasonable

⁷⁹ McKie, *Tin Cans and Tin Plate*, 94-95.

⁸⁰ *Ibid.*, 96. Heekin's former plant in Cincinnati is operated today by the Brockway Standard Corporation and makes a variety of cans. The former Heekin plants in Arkansas and Tennessee were sold in the early 1990s to the Ball Corporation. The plants are still in operation and primarily manufacture food cans (author).

prices made self-manufacture a less viable economic decision except for the largest of canning firms. In the opinion of economic historian and industry observer James McKie, "there are certain obstacles to entry into self-manufacture" due to the failure to "make headway against the economies of scale and diversification in already-established firms."⁸¹ He also noted that the trend away from self-manufacture began in the 1910s or earlier with the advent of large national can manufacturing companies. In 1913 it was estimated that one-third of the cans in the United States were self-manufactured. By the end of World War II, self-manufacturing firms constituted only 12 percent of the entire food can market.⁸² The barriers to entry were not absolute in can manufacturing after the 1930s, but after the 1940s there were no new entrants that remained in business longer than a few years.

The creation of both American Can and Continental Can and the rise of the "middle tier" firms had an immediate effect upon the can manufacturing industry that can be readily seen in census data. Can manufacturing was first reported as a distinct industry, "Tinware, not elsewhere specified," in the 1904 Census of Manufactures. As a relatively new industry with both specialist and self-manufacturers, early figures were reported with the caveat that the data "does not cover the manufacture of tin cans and other containers by establishments engaged in canning and preserving."⁸³ In other words, data from firms engaged in self-manufacture were not included, therefore the

⁸¹ McKie, *Tin Cans and Tin Plate*, 110-111.

⁸² *Ibid.*, 110.

⁸³ U. S. Department of Commerce, Bureau of the Census, *Abstract of the Census of Manufactures 1914* (Washington, D. C.: GPO, 1917), 217

data fairly accurately portrayed the business activities of the specialist can companies. The data demonstrate rapid industry concentration and growth in the twenty-five years following consolidation and the rise of American, Continental, National, and Pacific Can.

Table 5.1 - Consolidation of Can Manufacturing

Year	# Plants	Production Workers	Total Value (\$000)	Value-Added by Manufacturing (\$000)
1904	377	16,919	41,893	15,645
1909	318	19,754	58,814	19,541
1914	294	22,284	81,931	28,090
1919	301	34,386	233,964	68,793
1921	244	22,711	168,305	59,577
1923	241	30,511	215,971	79,991
1925	221	29,901	260,360	84,581
1927	236	29,721	253,479	84,058
1929	232	31,497	296,901	101,914

Source: Data taken from United States Department of Commerce, Bureau of the Census, *Census of Manufactures 1958*, Volume II, Industry Statistics, Part 2, Major Groups 29 to 39 (Washington, D. C.: GPO, 1961), 34A-5.

In 1914, ten years after the creation of American and Continental, the major locations for can manufacturing, in terms of the total value of product and the number of production workers were New York, Illinois, and Maryland. All three of these states had been major centers for can-making prior to American and Continental. California was still included in the "others" category in the 1910s, but it was becoming an increasingly important center for both canning and can manufacturing.⁸⁴

The data clearly demonstrate patterns of consolidation and concentration in the industry. At a macro-level, there were fewer plants manufacturing cans post-

⁸⁴ U. S. Department of Commerce, Bureau of the Census, *Census of Manufactures 1914*, Volume II, Reports for Selected Industries and Detail Statistics for Industries by States (Washington, D.C.: GPO, 1919), 1028-1029.

consolidation, yet the industry was growing. The number of plants had decreased from 377 in 1904 to 232 in 1929, nearly 40 percent. Yet while the number of plants decreased, the number of production workers and total value of the products they manufactured increased dramatically. The number of production workers increased 86 percent, while total value increased over 600 percent. In terms of productivity, a production worker in 1904 generated an average of \$945,000 in annual manufacturing value-added compared to 1929 when this same employee contributed 3.25 million dollars annually. By any measure, the industry was growing and employees were more productive after consolidation.

Consolidation and Alfred Chandler

There are several areas where the consolidation of the can manufacturing industry does not fit Alfred Chandler's hypotheses. First, the formation of the industry leaders, American Can and Continental Can, was neither because of administrative coordination replacing market mechanisms nor the existence of a salaried managerial hierarchy. In the case of American Can, the company emerged out of financial machinations designed to dominate can manufacturing. The formation of American Can was not based on an intent to capitalize upon any innovative product or process they had created, because none existed; rather, its goal was to monopolize the can manufacturing industry. The firm would subsequently exploit radical can-making innovations of other inventors, such as the integrated assembly line and the sanitary can, through capital investment and further acquisition activity. As Judge Rose wrote,

"it remains true that defendant [ACC] acquired its controlling position in the trade as the result of an unlawful combination; that such control, even when legitimately acquired, if not illegal, is at best a danger."⁸⁵ The objective at formation was to control and dominate the market -- the salaried managers and administrative bureaucracy would come later. There were no professional salaried managers at their formation, save Edwin Norton. Judge Rose stated "the men who brought about the organization of the defendant [ACC] do not appear to have been more than five in number, and only one of them, Edwin Norton, was a can maker."⁸⁶ American Can attempted to monopolized the industry first, then subsequently construct a managerial and administrative control structure to operate the company, not vice versa.

The formation of Continental Can in 1904 was a consequence and result of American Can's attempt to monopolize the can manufacturing industry. There were two key factors which distinguished Continental from American. First, unlike American, Continental had a seasoned corps of can-making veterans in their initial group of salaried managers. Most of these managers were former American Can employees, such as Edwin Norton, Thomas Cranwell, and Frederick Assman. In this regard, Continental did have a professional group of salaried managers, much as suggested by Chandler. The second factor which distinguished Continental from American, during formation, was a customer that was the largest consumer of tin cans in the world and around which a business could be built -- the Campbell Soup Company. The

⁸⁵ *United States v. American Can Company, et. al.*, 230 F. 862 (D. Md. 1916).

⁸⁶ *Ibid.*, 230 F. 866, 867 (D. Md. 1916).

administrative apparatus to manage the business was built around the Campbell Soup Company account. Like American, Continental did not have an innovative product, process, or administrative bureaucracy which led to their future success. In sum, Continental had professional salaried managers and a large customer at their foundation, but not an administrative mechanism for better control. This element of Chandler's hypotheses came later in their corporate history.

Second, market mechanisms placed an effective restraint upon the industry duopoly in how they priced their products and also governed their responses to changing customer expectations, thereby ensuring their survival. Market forces, in particular competition between American and Continental, were a limitation placed upon both companies in terms of pricing. This was a phenomena that occurred within a few years of their formation. Stable pricing became a hallmark of the industry within a few years of industry consolidation. By the mid-1910s, despite the emergence of managerial and administrative control features, American Can had lost the power to arbitrarily dictate their price, because of competition. Judge Rose observed this when he wrote "they [competitors of ACC] never name their prices for the year until the defendant's have been made public. On the other hand, the potential, if not the actual, competition to which the defendant is exposed, prevents it from arbitrarily fixing its prices at a higher figure."⁸⁷ Besides stable pricing, the duopoly survived because it offered customers new products, technical assistance, and provided other services, such

⁸⁷ Ibid., 230 F. 892 (D. Md. 1916).

as free storage of cans.

Third, unaccounted for by Chandler was how the federal government provided an effective check on the unbridled growth of corporations. This was clearly a factor in the future growth of American Can and a subject which conditioned the minds of future senior executives, such as William Stolk, into the 1960s. The ever-present threat of dissolution was a constant sword held perilously over the heads of American Can if their behavior, because of their dominant market position, ever became a peril to the public. Judge Rose declared in 1916 "if the defendant shall hereafter do anything which will justify or require the action of the court, there would seem to be no reason why the government should not promptly get the relief, to which it would then be entitled, at little cost to anybody."⁸⁸ The "relief" to which he referred was dismemberment of the company. As a result, the market position of American Can in food cans never varied much from roughly 50 percent of the market, which it enjoyed from the mid-1910s, until their dismantling in the 1980s. American increased its business through expansion of the overall market for food cans, thereby increasing sales. As the previously referenced *Fortune* magazine profile concluded in 1941, employees at American Can pointed with pride at their stable market share of 50 percent.

Finally, Chandler was factually incorrect on a number of points concerning the consolidation of can-making, although in fairness, some of his observations were accurate. First, several important customers of the can companies pioneered "adopting

⁸⁸ *Ibid.*, 230 F. 904 (D. Md. 1916).

and integrating the new ways of mass production and mass distribution" thereby becoming "nationally known."⁸⁹ Among his list were Campbell Soup, Heinz, and Borden. These companies were among the first to couple mass production with mass consumption. Chandler was also correct on a second point that many of the national brands used advertising to increase demand for their products. In his words, "advertising was important to enlarge demand." A few firms, such as Campbell Soup, "were soon selling and delivering directly to retailers."⁹⁰ Finally, he was correct about the importance of California Packing, later known as Del Monte, to the canning industry in the western United States. He argued they used continuous-processing equipment to sell low-priced packaged goods. The company had resulted from a "1916 merger of local canning companies that built a nationwide marketing organization and an extensive -- if more regional -- purchasing network."⁹¹ California Packing was certainly a formidable competitor in their region of the country, but they were a canner and marketer, not a can-maker.

There were numerous instances, however, where Chandler was factually wrong and attempted to force canning, can manufacturing, and the formation of American Can and Continental Can into his narrative. He was wrong about the Campbell Soup Company and self-manufacture of tin cans. He stated that Campbell Soup, in addition to Heinz and Borden's Milk, was one of the first firms to use the Nortons' "'automatic line'

⁸⁹ Chandler, *Visible Hand*, 298.

⁹⁰ *Ibid.*, 298.

⁹¹ *Ibid.*, 349.

canning factory" in 1883 and because of this "at once became and still remain, nearly a century later, among the largest canners in the world."⁹² He later stated that Campbell Soup was one of "the first enterprises to utilize fully the 'automatic-line' canning factory."⁹³ Chandler is wrong on two counts. He conflates can-making and canning, yet these two enterprises had separated in the 1880s. The Norton Brothers "automatic line" was designed to manufacture tin cans, not fill them. Additionally, while Campbell Soup may have had a filling line that was a continuous process, they did not begin manufacturing their own cans until the 1930s. They were a foundational and key customer of Continental Can.

Chandler was incorrect about the consolidation of the canning industry. He argued that "where canning remained seasonal, as was the case for vegetables [and] fruit . . . the large company did not appear." Del Monte, Libby, McNeil, and Libby, and Heinz were major fruit and vegetable packers, and were certainly large corporations. Additionally, although a minor point, he stated that Continental Can was "formed in 1906."⁹⁴ Continental was formed in 1904. Both American and Continental concentrated on manufacturing "packers cans" for vegetables and fruits in their early years. American

⁹² Ibid., 253. Chandler's source was May, *Canning Clan*, 350-351. May's production figures for the Norton "automatic line" were correct and taken from articles published in 1883 by *American Machinist*, Vol. 6. No. 28 (July 14, 1883): 1-2 and *Scientific American Supplement*, Vol. XVI, No. 398 (August 18, 1883): 6346-6347. However, May made no claim regarding Campbell Soup, Heinz, or Borden's Milk being the first adopters of the Norton "automatic line." For readers interested in adoption by canners, Chandler, *Visible Hand*, fn13, 557 states "For other canners see Chapter 9."

⁹³ Ibid., 295. Chandler cited May, *Canning Clan*, 351-353, but this source has no information concerning adoption of the Norton "automatic line" by mass marketers of processed food products and only treats the development of the integrated can manufacturing line by Norton Brothers. See Chandler, *Visible Hand*, fn15, 562.

⁹⁴ Ibid., 296.

and Continental would also both qualify as large companies.

Chandler argued that "American Can and Continental Can, both the result of mergers, provided cans and canning machinery for small canners who normally operated on a seasonal basis."⁹⁵ Chandler never stated what constituted a "small canner." However, both companies sold to large customers, such as the Campbell Soup Company. They also attempted to level the seasonality in fruit and vegetable production by expanding geographically and developing new products, such as motor oil and beer cans, which did not exhibit seasonality. Additionally, neither company ever made, nor sold "canning machinery." They made and sold can-making machinery, while other companies, such as Sprague Manufacturing, perfected canning machinery.

Finally, Chandler believed that the managerial revolution described in his tome was "little affected by public policy."⁹⁶ He seemed to disregard anti-trust legislation of the 1890s and actions against companies such as Standard Oil, United States Steel, and American Can in the 1910s. The dissolution and dismemberment of Standard Oil is well known, while the permanent threat of a similar action against American Can conditioned their future business practices. Government action was certainly an instrument used prevent monopolization and restraint of competition during the rise of corporations in America.

⁹⁵ Ibid., 357.

⁹⁶ Ibid., 376.

Conclusion

The consolidation of the can manufacturing industry stabilized prices for consumers and even lowered them over time. The first decade of the twentieth century was tumultuous, but thereafter prices tended to stabilize. Even in 1913 prices were trending downward. In 1916 Judge Rose wrote "a great many consumers of cans testified that the price has tended downward. Up to the time of the closing of the evidence in this case, that was generally true. There were fluctuations, and the downward trend was slight; but there was such a trend."⁹⁷ The continuous improvement of machinery increased throughput on can assembly lines, thereby decreasing unit costs, and some of these savings were passed along to consumers. Material conservation was also a factor, as there were incessant efforts since the late nineteenth century to reduce the amount of solder used in can fabrication. The increasing popularity of the sanitary can, a container that consumed less solder than a hole-in-cap can, also lowered prices over time. Can prices were slightly above two cents per #2 can in the mid-1910s and stayed under three cents per can until the mid-1930s.⁹⁸ Prices for tin-plated steel, the major component of material costs in a can played a role in stabilizing can costs. However, competition between American Can and Continental Can, along with other smaller companies, ensured that the monopolistic impulses of American Can in 1901 were thwarted. From the perspective of the can consumer, consolidation was an economic benefit.

⁹⁷ *United States v. American Can Company, et. al.*, 230 F. 893 (D. Md. 1916).

⁹⁸ *Fortune*, April 1934, p. 77.

The case of industry consolidation in can manufacturing cannot be forced into Alfred Chandler's model of the dominance of corporations in the late nineteenth and early twentieth century's. At best, some aspects of his hypotheses describe the industry, while many others do not. The formation of American Can was a gambit by financiers to monopolize the market in tin cans, and the subsequent creation a few years later of Continental Can was the result of American's original intent. Neither company developed the technology for manufacturing cans, nor the increasingly prevalent product form, the sanitary can. Perhaps both the leading manufacturers fit Chandler's model later in their histories and developed improved machinery and products, but not before they controlled nearly 75 percent of the industry. The role of administrative mechanisms and a professional salaried management team played little part in their initial market ascendancy. In fact, the dual constraints imposed upon American Can limited the degree to which they could dominate the market for tin cans. Market forces and competition placed a brake on prices, while the ever-present threat of government dissolution obliged them to be wary about any future activities which could be construed as anti-competitive. Regardless of the constraints forced upon American, they were an important element of the American economy throughout most of the twentieth century. American Can was a component of the Dow Jones Industrial Average, a barometer of the health and complexity of the American economy, from October 4, 1916 until March 12, 1987.⁹⁹ Historians' sometimes amuse themselves with

⁹⁹ <http://stat1.moneycontrol.com/Dow Jones Industrial Average Historical Components.pdf>,
340

counterfactual history. One cannot profess with clarity whether there would have been a later attempt to dominate the can manufacturing industry if neither American Can nor Continental Can had been created, or if the industry would have matured as something other than a duopoly. What is incontrovertible, however, is that the pace and shape of change within the industry would have been different without either or both companies.

Whether the consolidation of can manufacturing was good or bad for the public is a value judgment. There are several facts, however, which suggest that consolidation was a benefit to consumers. First, the research and development efforts by both American Can and Continental Can provided many new products for customers, as well as improved versions of food cans. Oil cans, beer cans, and garbage pails are but a few of the examples. Canned food quality improved because of development of linings capable of preventing degradation of certain food products, such as sweet corn. Second, continuous incremental improvement by the machinery manufacturing operations, at both leading companies, of can-making equipment originally developed in the late nineteenth century, and perfection of the sanitary can, increased throughput on can assembly lines thereby lowering the cost of manufacturing. The savings in manufacturing costs were passed along in the form of stable or reduced pricing for consumers. The mechanical innovation post-consolidation and through the 1930s was incremental in nature, with no significant breakthrough machines developed by either

(accessed May 23, 2013).

company. Technological innovation post-consolidation focused on incremental improvements to machinery, while product development innovation sought breakthrough advances to expand the uses for tin cans and the products which could be packed in them. Finally, the intense competition between American Can and Continental Can and attempts to differentiate themselves from each other through quality and service, not price, further insured that predatory pricing was an archaic practice. If either company attempted to increase prices, it would soon be met with lower prices from the other. As early as 1916, Judge Rose had concluded that American Can had done nothing unscrupulous in the immediate years preceding *United States v. American Can, et. al.* that suggested they restrained competition. In fact, American Can was regarded as a great benefit to the industry by competitors and customers alike. In short, consolidation of can manufacturing in the early twentieth century and the formation of a market duopoly ensured that reasonable pricing reigned within the industry.

Despite wide diffusion of the tin can by the early twentieth century, both American Can and Continental Can were not immune to negative public perceptions of their primary product, food cans. Diffusion of the tin can in the late nineteenth century, subsequent improvements in technology, and consolidation of the industry all led to less expensive tin cans for consumers. However, these phenomena would be futile unless specialist can manufacturers could broaden the market for their products and increase the overall size of the industry, and subsequently their companies. One method to

expand business was to develop new products, an example of expanded scope. The other was to affect customer demand, as will be explained in the next chapter.

Chapter 6 - Managing Demand and Customer Expectations

Nothing has done more to lighten the burden of the kitchen than the modern cannery. The taking of the work away from home and away from observation, except to a comparatively few, has developed a lurking suspicion that possibly some of the material used and the care taken in its preparation are not all that they should be, and this suspicion has grown to a prejudice against canned foods. A presentation of the facts may serve to correct some of these misapprehensions.

A. W. Bitting, M.D. and K. G. Bitting, M.S., 1916¹

They [critics of canned food] cannot deny the visible mitigation of drudgery over the kitchen stove and the kitchen sink which has come with the prepared food package in can, jar or paper carton.

New York Times, 1930²

Arvill Bitting and his wife Katherine wrote the above words in the introduction to their 1916 treatise *Canning and How to Use Canned Foods*. Arvill, a medical doctor and Katherine, a chemist, spent much of their lives promoting the virtues of canned food. The purpose of their work was to explain to the American public how canned foods were manufactured, reassure them of the sanctity and safety of the product, and provide recipes for canned foods. Their comment fairly summarized the status of canned foods in the second decade of the twentieth century. By 1916 canned foods were a fixture in most kitchens and a component of the American food landscape. They had indeed removed "drudgery" from the kitchen for many American women by 1930, as reported in the *New York Times*. Canned foods were a convenient method of food preservation, were affordable for most Americans, and offered consumers a wide

¹ A. W. Bitting and K. W. Bitting, *Canning and How to Use Canned Foods*, 9.

² *New York Times*, 5 October 1930, p. E1.

variety of fruit and vegetable products, often when out of season. The growth in the use of canned foods was in no small part because of demographic shifts. The growing number of Americans living in urban areas had separated producers from consumers of food. Yet, despite the seemingly positive benefits and bright future of canned foods, there were some "misapprehensions" surrounding the product. The misgivings often had cultural roots or were the product of sensational stories of food adulteration in the press. Cannerymen and can-makers, alike, had a vested interest in changing consumer perceptions.

This chapter investigates how cannerymen and can manufacturers endeavored to increase demand for their products and at the same time attempted to offset negative public perceptions of canned foods. There were two techniques primarily intended to allay customer concerns. First, beginning in the 1890s, scientific methods were applied to canning intending to replace the secretive, empirical processes by which canned foods had been prepared. An industry with "scientific" credentials would alleviate consumer fears. Second, in the first decade of the twentieth century a cannerymen's trade and lobbying association, the National Cannerymen Association (NCA), was founded. The purpose of the organization was to educate and inform the public about the merits of canned foods and establish industry-wide standards for processing, as well as respond to any negative media stories concerning canned foods. The Association was also a reaction to the 1906 Pure Food and Drugs Act. All participants in the canned food industry, including can-makers, were members of the NCA. Another thirty years passed

before a separate trade organization, the Can Manufacturers Institute, was formed solely for can-makers.

The market for canned foods was increasing because of urbanization, and the canning and can manufacturing industries were increasingly dominated by several large companies. The goal for the major companies, in both industries, was to increase the appeal of canned food, thus expanding the market. Advertising was the primary method employed by canners and can-makers to bolster demand. Aggressive advertising, primarily in magazines directed toward middle-class women, contained many interesting and nuanced themes, nearly all addressing the housewife's role in preparing meals for her family and entertaining guests. Advertising served the two roles: it assuaged negative perceptions and attempted to increase demand for canned food. Nearly all industry participants placed advertisements -- canners, can manufacturers, and trade organizations.

Canned Food Consumption

Reliable and affordable, canned food became firmly established as a fixture in the kitchen and American food landscape between 1900 and 1920. The can-making industry experienced continued growth from the late nineteenth century onward. Before the Civil War, estimates placed the size of the canned food industry at 5 million fruit and vegetable cans manufactured and consumed annually. By the end of the War,

the figure had risen to 30 million.³ The increased production and consumption of canned foods in the late nineteenth century corresponded with the mechanization of the industry and the myriad of technological innovations. By the mid-1890s, annual production and consumption of canned fruits and vegetables had risen to 500 million cans annually. Production of all canned foods, including soup, meat, milk, seafood, and fruits and vegetables, was close to 1 billion cans annually.⁴ Using the above figure of 500 million fruit and vegetable cans annually consumed in 1896, and factoring in an annual growth rate of 7 to 8 percent, a conservative estimate of the annual growth rate, a rough approximation of the market size in 1900 was between 650 and 680 million cans.

Prior to 1904, United States Census data listed annual canned fruit and vegetable production not in terms of cans or cases packed, but in pounds processed. The following chart lists annual fruit and vegetable cans packed by all canners in the United States during the first two decades of the twentieth century. The number of cans packed in a year is a fair metric to use for estimating the number of cans produced by can manufacturers in any given year. If anything, using cans packed versus cans

³ There is no U. S. Census data available on annual production and consumption of tin cans prior to 1870. Various sources have estimated the figure of 5 million, and this has become a historically accepted fact. See Collins, *The Story of Canned Foods*, 15-17; Boorstin *The Americans: The Democratic Experience*, 316; Jane Busch, "An Introduction to the Tin Can," *Historical Archaeology*, Vol. 15, No. 1 (1981), 97; Brooke Hindle and Steven Lubar, *Engines of Change: The American Industrial Revolution, 1760-1860* (Washington, D. C.: The Smithsonian Institution Press, 1986), 105. There are no data on the number of cans produced or consumed contained in the 1870 Census. However, 30 million cans is the generally accepted figure used by various authors. See Collins, *The Story of canned Foods*, 15; Kuhlmann, "The Processing of Agricultural Products in the Pre-Railway Age," in *The Growth of the American Economy*, ed. Harold F. Williamson, 203; Boorstin, *The Americans: The Democratic Experience*, 316; Busch, "An Introduction to the Tin Can," 97.

⁴ *New York Times*, "Perfection of Canned Goods," 26 July 1896, p. 12.

produced slightly understates the size of the market, as some empty cans are invariably in inventory at both the can-maker and canner.

Table 6.1 - Market Size - Canned Fruits and Vegetables - Early Twentieth Century

Year	Cases Packed Vegetables	Cases Packed Fruit	Total Cases Packed	Total Cans Filled (Millions)
1904	29,719,879	4,628,241	34,348,120	824.4 M
1909	34,656,179	5,528,878	40,185,057	964.4 M
1914	50,258,674	9,449,182	59,707,856	1,433 M
1919	58,108,311	21,432,393	79,540,704	1,909 M
1921	38,186,041	12,516,014	50,708,055	1,217 M
1923	75,751,122	20,328,957	96,080,079	2,306 M

Source: Data for 1904 through 1914 is taken from U. S. Department of Commerce, Bureau of the Census, *Census of Manufactures 1914*, Volume II, Reports for Selected Industries and Detail Statistics for Industries by States (Washington, D.C.: GPO, 1919), 376-377. Data for 1919 through 1923 is taken from U. S. Department of Commerce, Bureau of the Census, *Census of Manufactures 1923* (Washington, D.C.: GPO, 1926), 67. The conversion factor from cases to cans is 24 because this is the number of cans per case for #2, #2½, and #3 cans, which were the predominant sizes used to pack fruits and vegetables.

The decline in consumption and manufacturing in 1921 was due to the nationwide recession of the early 1920s. Regardless of general economic conditions, the canning and can manufacturing industries expanded from 500 million fruit and vegetable cans annually in the mid-1890s, to 1.9 billion in 1919, a 280 percent increase over the course of twenty-five years. By 1936, the annual pack of fruit and vegetable cans was 4.12 billion.⁵ When all canned foods such as soup, meat, milk, and seafood are

⁵ American Can Company, *The Canned Food Reference Manual*, 2d ed. (New York: American Can Company, 1943), 452-453. The data are presented in cases, therefore conversion by the number of cans per case was used to arrive at this figure.

included, Americans were consuming nearly 7.2 billion cans annually by the mid-1930s.⁶ By any measure, canned foods were a fixture in American culture by the 1920s, and consumption continued to increase thereafter.

Chart 6.1 - Annual Per Capita Consumption of Canned Fruits and Vegetables

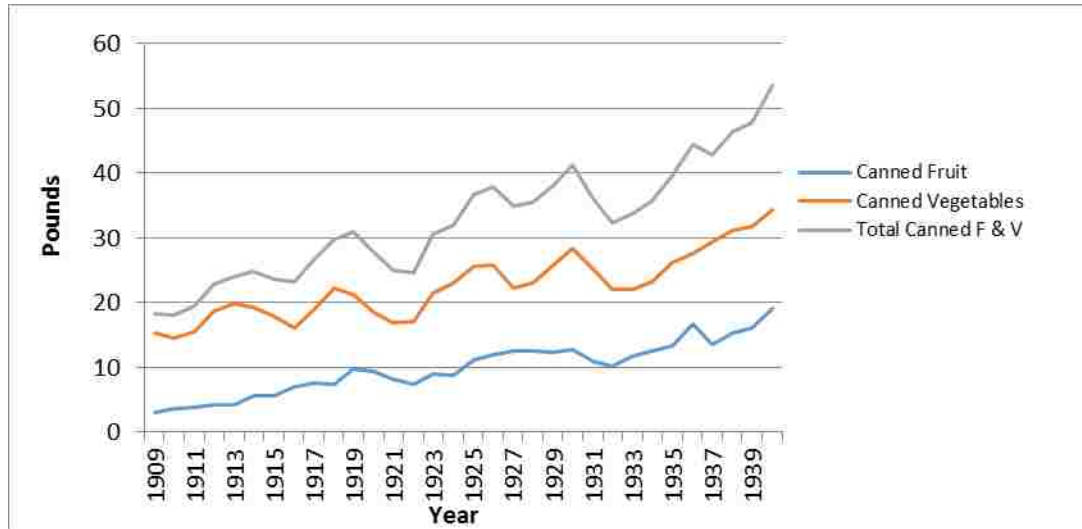

Data From: U. S. Department of Commerce - Bureau of the Census, *Historical Statistics of the United States: Colonial Times to 1970, Part 1* (Washington, D. C.: GPO, 1975), 329-331.

The above chart demonstrates that total annual per capita consumption of canned food climbed significantly from 1909 until 1940, thereby supporting the dramatic expansion of the can manufacturing industry in the early twentieth century. Despite the general upward trend in consumption, the data show several spikes. During World War I consumption spiked, but the immediate post-war years showed a decline. Likewise, consumption declined during the early years of the Great Depression from

⁶ Unattributed, "Profits in Cans," *Fortune*, Vol. IX, No. 4 (April 1934): 77. The article stated that 60 percent of the 12 Billion cans used annually by Americans were food cans, therefore 7.2 billion was the market size for all canned foods in the mid-1930s.

1929 until 1933, then began a slow upward climb again. The variation in total consumption generally reflected the economic conditions in the country. Despite the peaks and valleys, total per capita consumption of canned fruits and vegetables climbed from 18.3 pounds per person in 1909 to 53.5 pounds per person in 1940, a growth of nearly 200 percent over the course of thirty years. Unquestionably, consumption of canned foods became a hallmark of twentieth-century America. Consumption of vegetables always exceeded that of fruit, because there were many more varieties of vegetables. Heavy consumption of tomatoes, corn, and beans began in the mid-nineteenth century. The canned fruit industry had a much later start and only became a robust industry in the late nineteenth century with the expansion of canning in California. While consumption of canned fruit lagged that of canned vegetables, there was less variability in the demand for canned fruit. Demand for out-of-season fruit items tended to stabilize, particularly in regions where fresh fruits were unavailable.

Census data on capital invested in the canning industry also support the argument that canning and canned food had become a dominant force in early twentieth-century American foodways. By 1899 invested capital, for the entire canned food industry, was \$59 million in current dollars or \$135 million 1929 dollars. In 1909 these figures were \$119 million in current dollars and \$224 million in 1929 dollars. By 1919 the figures were \$378 million and \$458 million respectively. In 1929 the book value of invested capital in canning was \$853 million. The greatest two decade period for growth, on a percentage basis, was between 1899 and 1919. Book value during this

time period, in 1929 dollars, rose \$323 million, or over 240 percent.⁷ Cannery had clearly invested more capital in their operations to match rising consumer demand for canned food.

Some reasons for the tepid growth of canning and can manufacturing in the mid-nineteenth century were explained in the Twelfth Census in 1900. Arthur Hunt, a descendant of the first large-scale cannery operators in California, wrote a lengthy essay for the Twelfth Census on the state of canning and preserving at the beginning of the twentieth century. He stated that canning had been largely confined to "three great commercial centers" and was not an industry "of much importance" until the last twenty-five years of the nineteenth century. Hunt listed six reasons for the slow growth of canning prior to the 1870s: "tardy introduction of machinery," "secrecy" surrounding the method of preserving fruits and vegetables, public "skepticism" on the "healthfulness" of canned foods, a "general prejudice against canned foods," the high costs of production, and the exorbitant prices for consumers. According to Hunt, "gradually these obstacles to progress were overcome," and by the end of the nineteenth century the industry had "spread over the country with remarkable rapidity."⁸ Hunt was partially correct in his analysis of the state of the industry. Certainly the introduction of technology, albeit at a non-uniform pace, had reduced costs of manufacture and lowered prices for consumers. However, eliminating the

⁷ U. S. Department of Commerce - Bureau of the Census, *Historical Statistics of the United States: Colonial Times to 1970*, Part 2 (Washington, D. C.: GPO, 1975), 684-685.

⁸ U. S. Department of the Interior, Census Office, *Twelfth Census of the United States Taken in the Year 1900*, Vol. IX, Part III, 465.

prevailing culture of "secrecy" in the industry and alleviating consumer concerns regarding "healthfulness" and the "general prejudice against canned foods" were challenges for the industry. It addressed them relentlessly in the first three decades of the twentieth century. Nevertheless, Hunt was accurate in asserting that consumption of canned foods was widespread in America by the early twentieth century.

Some modern food historians do not agree with Hunt's analysis of the general acceptance of canned foods in America by the first decades of the twentieth century. Gabriella Petrick, in her 2006 dissertation "The Arbiters of Taste: Producers, Consumers and the Industrialization of Taste in America, 1900-1960," argued that misgivings, skepticism, and fear about canned food retarded its development as an article of mass consumption until the 1930s. Petrick traced "the transformation of the American diet from one made in the home to one increasingly made in a distant factory." She endeavored to investigate the "interplay between technology and cultural practice" by examining technological advances and how consumers used new foods in their daily lives.⁹ Her overall argument was that the "heavily industrialized diet" consumed by most Americans was neither inevitable nor certain, but the product of choices made by both producers and consumers of mass produced foods.¹⁰ Petrick inserted the voice of the consumer in the ever-increasing demand for canned foods: the choices faced by consumers were less flavor in canned foods versus the positive attributes of menu

⁹ Gabriella M. Petrick, "The Arbiters of Taste: Producers, Consumers and the Industrialization of Taste in America, 1900 - 1960" (Ph.D. diss., University of Delaware, 2006), 1-2.

¹⁰ Ibid., 4.

variety and the elimination of seasonality.

Petrick investigated four major areas of industrialized food: canning, lettuce production in the Salinas Valley of California, frozen foods, and the consumption of carbonated beverages by teenagers in postwar America. Her chapter on canning begins with an anecdote about a case of botulism poisoning due to a can of string beans consumed at a Stanford University dinner party in 1913. This story underscored her larger argument about canned foods: fears and uncertainty surrounding canned foods retarded their mass consumption in American until the late 1930s when the application of science to canning placated consumer concerns. In fact, Petrick claimed canned foods were a "novelty" in American prior to World War I.¹¹ In her brief analysis of how technology transformed canning and can-making, Petrick emphasized the impact of Shriver's steam retort on improving throughput on canning lines and Charles Ams development of the sanitary can. There was no mention of improved bench tools, floating machines, body makers, faster punch presses, or the integration of can-making lines by Norton Brothers. Her final comment on canning and can-making technology was "despite the scientific and technical progress in canning in the years before World War I, the public's uneasiness with these new industrial foods took several decades to subside."¹² Nowhere does she use objective data to support her claims, only anecdotal stories served as evidence.¹³ In her conclusion, Petrick stated "by the 1930s, the mass

¹¹ Ibid., 20.

¹² Ibid., 25.

¹³ Petrick made the fantastic claim that "even today [2006], the vague possibility of contracting ptomaine poisoning from canned foods lingers in the public consciousness." Ibid., 37.

production and distribution of canned foods transformed them from luxury goods for the middle and upper classes to everyday foods for the working class."¹⁴ According to Petrick, the democratization of canned foods was a twentieth-century phenomenon, when in actuality it had been occurring since the 1870s.

In a 2010 article "An Ambivalent Diet: The Industrialization of Canning" Petrick made many of the same arguments as she had in her dissertation. She was correct in her contention that "consumers were not passive victims, but rather played an active role in technological dissemination by choosing whether or not to purchase canned foods. As a result . . . they pressured the industry to use science and technology to gain public trust by creating a product that was increasingly safe, efficient, and tasty."¹⁵ Consumers were customers and the activities of canners and can manufacturers were directed to meet their expectations. With few consumers and little demand, canning and can-making would have remained dormant industries. If customers had expectations, the industry had to meet them. It is true that skepticism surrounding canned food subsided only with the application of science and a "collaborative effort by the government, industry, and academy."¹⁶ However, Petrick was incorrect in her assertion that "the confidence we tend to have in canned food is primarily a post-World War II phenomenon."¹⁷ Consumer acceptance of canned food began in the late nineteenth century and was an established article in the American diet by the early

¹⁴ Ibid., 63.

¹⁵ Gabriella M. Petrick, "An Ambivalent Diet: The Industrialization of Canning," *Magazine of History*, Vol. 24, No. 2 (July 2010): 35.

¹⁶ Ibid., 38.

¹⁷ Ibid., 35.

twentieth century. Consumers were confident enough in canned foods to eat it in ever-increasing quantities, as depicted in Chart 6.1, thereby driving the growth of the market as illustrated in Table 6.1.

The data in Table 6.1 and Chart 6.1 demonstrate a pattern of increased production of cans and per capita consumption of canned fruits and vegetables by Americans in the same time period Petrick argued they were viewed with skepticism by the public. The nineteenth-century proliferation of canning from the coasts to the interior of the country, continued growth in the number of canneries throughout the country, and investment in capital equipment in the can manufacturing industry all speak to increased consumer demand. One could argue that consumer concerns over canned foods decreased their desirability and limited demand to some degree, but there can be little doubt the appeal of canned foods had been increasing since after the Civil War. Cases of food poisoning were reported in the media, and often the tin can was portrayed as the culprit. While the counter-narrative to the progress of canning did in fact exist, it was a minority discourse. Petrick was correct that the impact of science, industry trade associations, and advertising all played roles in placating consumer fears. However, any misgivings about the tin can in the public mind seemed to have had little impact on reducing the ever-increasing demand for canned foods.

The consumer appeal of canned foods can be partially explained by Ruth Schwartz Cowan's 1987 essay "The Consumption Junction." Her argument was that researchers must look at consumers and their available choices when evaluating

matters of technological diffusion and acceptance. According to Cowan, the consumer of a new technology is embedded in a network of social relations. The network of social relations places limits on the technological choices available to the consumer and the decisions they are capable of making. Key to her argument is that the consumer is placed in the center of decision making on new technologies, the consumption junction, and the network must be viewed from the consumer's point of view -- from the inside looking outwards. In her words, "I focus on the consumption junction, the place and the time at which the consumer makes choices between competing technologies, and try to ascertain how the network may have looked when viewed from the inside out." This focus enables researchers to determine "which elements stood out as being more important, more determinative of choices," and "which paths seemed wise to pursue and which too dangerous to contemplate."¹⁸ Cowan used home heating and cooking systems as an illustrative example. Her conclusion was that as consumers desired attributes such as fuel efficiency, more comfort, and a cleaner environment, certain features and models became more prevalent in home cook stoves. Manufacturers changed production methods, prices declined, and more stoves were purchased by the public. Consumers had forced product differentiation in the marketplace. According to Cowan, "a group of businesses was created that specialized in manufacturing one product and serving only one kind of consumer, the householder."¹⁹

¹⁸ Ruth Schwartz Cowan, "The Consumption Junction: A Proposal for Research Strategies in the Sociology of Technology," in *The Social Construction of Technological Systems*, eds. Weibe Bijker, Thomas P. Hughes, and Trevor J. Pinch (Cambridge, Mass.: MIT Press, 1987), 263.

¹⁹ *Ibid.*, 273.

Cowan's argument has significance for the consumer appeal and diffusion of canned foods. Prior to tin cans, food was eaten fresh, salted, dried, pickled, sugared, or smoked. From a consumer's standpoint, whether a soldier in the army or an urbanite, canned foods were an appealing choice compared to other food preservation technologies. They added variety to the diet, were convenient to store, relatively simple to prepare, and eliminated seasonality. The drawback, however, was that canned foods were expensive in the mid-nineteenth century and were initially viewed with some suspicion. Cannery and can manufacturers initially used improved technology to reduce the cost of canned foods, a key consumer expectation, while they subsequently began to address consumers' concerns about the safety of canned food. The result was that canned foods began growing in popularity in the late nineteenth century, and this trend continued into the twentieth century. Simply stated, from the consumer's point of view, canned foods had advantages over other food preservation technologies. However, canners and can manufacturers, had to make adjustments to the product for it to gain even greater appeal.

The advantages of canned foods were addressed by Arvill and Katherine Bitting in their 1916 tome *Canning and How to Use Canned Foods*. The Bittings were proponents of canning, so one would expect their comments to extol the virtues of canned foods, while minimizing their dangers. They listed several advantages of canned food. In their view, canned foods were for more than just emergencies or entertaining unexpected guests. The Bittings believed these were common reasons consumers

purchased canned foods, but contended "the tendency of the basic reasoning is somewhat illogical and misleading." They argued that canned foods should be consumed more often because they were more economical, particularly in large cities. They wrote, "in the rural districts and in the smaller cities and towns, the cost of fresh material is low, but in the larger cities it may not be cheap in any season." They cited the example that it took four ears of corn to provide the same contents as one tin can of corn.²⁰ Second, since canners purchased in bulk and distributed their products nationally, they were able to provide better cost and higher quality products than fresh produce. Fresh produce shipped from some regions of the country was much more expensive than their canned counterpart. They cited peas, string beans, tomatoes, and asparagus as examples. Their reasoning was that canners were the experts, therefore they knew better than consumers "the basis on which to make a discrimination between the two [fresh and canned] in the matter of cost."²¹ Third, the canner had already graded, washed, and prepared the product, therefore canned foods were convenient and reduced preparation time. According to the Bittings, the canner had eliminated the "rough work" and enabled the "housekeeper" to spend more of her food preparation time on "the part requiring skill."²² Finally, canned foods offered an incredible variety of items often unavailable locally and out-of-season. Additionally, their cost could be reduced by purchasing in "case lots," rather than a single can.²³

²⁰ A. W. Bitting and K. W. Bitting, *Canning and How to Use Canned Foods*, 91.

²¹ *Ibid.*, 91-92.

²² *Ibid.*, 92.

²³ *Ibid.*, 93.

The Bittings also used their work to explain and reassure readers of the safety of canned foods. An appendix titled "Food Poisoning" sought to explain why cans were often unfairly identified by the public as the culprit in many cases of food poisoning. They treated the subject in a broad context and cited twelve different alleged reasons why people became sick after consumption of canned foods. The believed causes ranged from illness due to "personal idiosyncrasy," contamination from using diseased or decomposed meats and fish, improper growing conditions for produce, acid or solder poisoning, elimination of vitamins during processing, and food intoxication due to over indulgence.²⁴ In all these cases, the Bittings minimized the role of tin cans in causing illness, but did not hold them guiltless. Their intention was to have a broader conversation about illness from canned foods and reassure those who were skeptical of the product. They concluded "it is not the desire of the writer to convey the impression that canned foods are blameless for some troubles, but owing to the methods of preparation and the impossibility of contamination while in the package, they present a minimum of danger."²⁵

Canned food consumption also increased because of changed transportation and distribution systems. According to Susan Strasser in her 1982 book *Never Done: A History of American Housework*, home canning of fruits and vegetables was uncommon in the nineteenth century due to the high cost of sugar and the unavailability of glass jars. Tin cans became more available in the mid-nineteenth century, and there was

²⁴ Ibid., 179-184.

²⁵ Ibid., 184.

some advertising done in the late nineteenth century to spur demand. Distribution systems began changing in the 1850s and 1860s, with food brokers and wholesalers becoming increasingly important to the food chain. The post-Civil War era experienced rapid technological advances in canning and can manufacturing, so that by 1900 "prepared food in cans and boxes, the result of mass production and mass distribution, entered consumers' kitchens during the first decades of the twentieth century."²⁶ There were several late nineteenth-century social developments that formed the foundation for the popularity of canned foods. National agricultural markets were enabled by improved transportation systems and distribution networks. When combined with advances in food preservation, factory production, and marketing, American diets were considerably altered by the first decade of the twentieth century from what they had been a few decades earlier. Americans ate less spoiled food, home canning using glass jars became fashionable, and there was more variety in the diet, all factors leading to better nutrition. According to Strasser, the housewife had lost the satisfactions of home production and became "dependent on industrial products as consumers," yet they welcomed the convenience.²⁷

Canned foods were an established article of the American food landscape in the early twentieth century. By the 1920s, canned goods were affordable for most Americans. Pricing for tin cans was fairly stable due to competition within the industry

²⁶ Susan Strasser, *Never Done: A History of American Housework* (New York: Henry Holt and Company, 1982), 22-29.

²⁷ *Ibid.*, 30-31.

and a market duopoly. Canned foods were readily accepted by consumers as reflected in census data because of their utilitarian nature and consumer appeal, for reasons posited by Cowan. Their advantages as extolled by the Bittings were yet another reason canned foods appealed to consumers. There was an undercurrent of skepticism surrounding canned foods, but any misgivings seem to have had minimal effect on the demand for canned food. Both canners and can manufacturers were capable of mass production, but they needed new products or a larger market to increase revenue. In short, mass production needed to be coupled with mass consumption. Underlying changes in transportation and distribution of food, as described by Strasser, led to a monumental demographic shift in America, the migration of consumers from rural areas to the cities.

Urbanization

Urbanization presented canners and can manufacturers with opportunities for growth. The Bureau of the Census defined the urban population as those persons living in incorporated places with 2,500 or more residents. In 1870, there were 39.9 million residents in the United States, with roughly 25 percent living in areas classified as "urban." By 1900, the population of the United States was 76.1 million, with slightly less than 40 percent classified as living in urban areas. In 1920 a landmark phenomenon occurred when, for the first time, a majority of the 106 million Americans resided in urban places. Urbanization continued, and by 1930 of a total population of 123 million

Americans, 56 percent lived in urban regions.²⁸ With more and more city-dwellers in the early twentieth century, consumers were now further away from the centers of food production. Urbanites still had to eat, but their options were limited to shopping at small grocery stores, purchasing fresh items from city markets, or dining out. Under these circumstances that limited consumer choices, canned foods had immediate appeal.

For the urban consumer of canned foods, according to Edward Woolley's March 1914 article in *McClure's Magazine*, "the chief benefits are wholesome food always available in great variety, and low prices."²⁹ Implied in his use of the term "variety" was convenience for consumers to have nearly any imaginable fruit or vegetable, even if out-of-season, readily available. Woolley also believed that canned foods were an enabler of urbanization. He unequivocally stated that "except for the canning industry, our present great cities must inevitably have been small cities -- for the good reason that a great city could not be fed without the help of canners."³⁰ He presented several statistics to support his contention, such as that New York City consumed \$150 million in canned food in 1913, a total equivalent to the combined purchases of milk, eggs, and bread in the metropolis. According to Woolley, New York City was always "on the ragged edge of famine" owing to labor strikes or snow storms. He contended that Chicago would never have become "half as big" without canned foods, and its

²⁸ U. S. Department of Commerce - Bureau of the Census, *Historical Statistics of the United States*, Part 1, 2, 8, 11-12.

²⁹ Edward Mott Woolley, "Tin Canners: The Story of the Greatest Utility Industry of the Age and the Men Who Built It," *McClure's Magazine*, Vol. 42, No. 5 (March 1914), 74.

³⁰ *Ibid.*, 78.

inhabitants "would be out on the land, scratching the earth for a living."³¹ Woolley was neither a statistician nor historian, and he could certainly be criticized for his theory of causation for urbanization. However, his arguments contained an element of truth, canned foods were consumed by persons of all social classes in large cities.

Changing social relations in the early twentieth century, when coupled with demographic patterns, increased demand for canned food in urban areas. As the exodus from the countryside to the cities began, many women entered the workforce. This was a new social phenomenon and made it difficult for women to combine work, household chores, and child rearing. Their days were now habituated, to a degree, by the fixed work hours at a factory, office, or department store. As a result, there was a trend to purchase articles that eased cleaning or cooking in the home. A search for convenience and easing household burdens was one reason purchases of canned foods increased. As stated by Jean-Louis Flandrin, a European food historian, "the increase in the number of women employed in factories and offices thus had a profound influence on the development of both the household appliance and processed food industries."³²

Consumption by the working-class in urban areas is a recent area of investigation for historians. In her 2007 work, *Household Accounts*, Susan Porter Benson argued that working-class consumption was an element of a complicated set of economic activities that included wage replacement, wage earning, household production, market-

³¹ Ibid.

³² Jean-Louis Flandrin, "Introduction: From Industrial Revolution to Industrial Food," in *Food: A Culinary History from Antiquity to the Present*, eds. Jean-Louis Flandrin and Massimo Montanari (NY: Columbia University Press, 1999), 436.

replacement, reciprocity, and market activity.³³ Benson believed that in the early twentieth century, the working-class was distinctly marginal to mass consumption. For this group of urban dwellers daily living was a chore; "consumption revolved around hard choices, about basic needs, and provided therapeutic satisfactions only secondarily, if at all."³⁴ The working-class participated in the urban marketplace, but only purchased necessities, and often from a local merchant with whom they had a personal relationship. They had limited funds; therefore they had to make hard choices. Food purchases were "the most vexed issue for most families" and often took priority over paying rent.³⁵ Affordability and value for the money were more crucial factors for urban working-class families, according to Benson, than variety, convenience, or copying middle-class consumption patterns. Canned foods were welcomed by the urban working-class because they had become inexpensive over time.

The urban working-class was not a homogeneous group, however, and purchases were often conditioned by cultural inheritance. For example in 1982, Virginia Yans-McLaughlin in *Family and Community: Italian Immigrants in Buffalo, 1880 - 1930*" argued that family and the larger Italian immigrant community affected a wide variety of choices for new arrivals, such as type of employment, place of residence, where to shop, and what church to attend. Italian immigrants generally rejected canned foods, preferring fresh fruits and vegetables. Canned foods were a food preservation

³³ Susan Porter Benson, *Household Accounts: Working-Class Family Economics in the Interwar United States* (Ithaca, N.Y.: Cornell University Press, 2007), 7.

³⁴ *Ibid.*, 8.

³⁵ *Ibid.*, 14, 140-141, 168-169.

technology with which Italian immigrants were unfamiliar. Additionally, women were uncertain how to incorporate canned products into traditional recipes. Ironically, while rejecting canned foods, many Italians found work in the canneries of upstate New York. The type of work appealed to them: it was seasonal, working in a cannery was a respectable occupation for women, and the entire family could often be employed in the same cannery.³⁶ Acceptance of canned foods often awaited subsequent generations of immigrant families.

Material considerations were factors for urban working-class families on decisions regarding what they could cook. In her 2008 dissertation, Katherine Leonard Turner argued that material conditions, not just cultural heritage, influenced what the urban working-class ate. By material conditions she meant "the physical and technological structure of people's lives." Turner continued and wrote, "food choices are conditioned by the time, space, and tools available to cook and eat with; people cooked not just what they wanted, but what they reasonably could cook in their circumstances."³⁷ Key to her argument was that the urban working-class made decisions in accordance with their situation and did not blindly follow consumption patterns of the middle-class. She mentioned canned vegetables and meats as one of many food choices available to the urban working-class. Canned foods were popular with the working-class because they were affordable, but only after 1900 when retail prices fell

³⁶ Virginia Yans-McLaughlin, *Family and Community: Italian Immigrants in Buffalo, 1880 - 1930* (Urbana: University of Illinois Press, 1982), 184-201.

³⁷ Katherine Leonard Turner, "Good Food for Little Money: Food and Cooking Among Urban Working-Class Americans, 1875 - 1930" (Ph.D. diss., University of Delaware, 2008), ix.

to levels within their reach. Turner wrote that "even poor working-class families used a small amount of canned food . . . prepared dishes, such as canned soup and spaghetti, were mostly sold to the middle-class, but almost everyone bought at least some canned fruits and vegetables."³⁸ In Turner's analysis, canned foods were purchased by the urban working-class because they provided variety for their diet, and were affordable as well.

The material conditions, living arrangements, of working-class people also made canned foods a wise choice. Turner argued that "workers lived in neighborhoods with inadequate utilities, and in crowded homes with outdated tools, compared to the neighborhoods and homes of the middle-class."³⁹ The kitchens of middle-class homes were a separate space and often equipped with the most modern technology. Working-class kitchens, by comparison, were not a separate space. They were small, lacked storage space, and were outfitted with few modern conveniences and tools. It was a multi-use space for cooking, eating, and socializing. For the working-class, the kitchen was a functional and social space versus a symbolic area for the middle-class. The lack of storage space affected what food the working-class purchased. They tended to buy more often and in small quantities.⁴⁰ Under these trying conditions, the working-class purchased cans because they were easy to prepare with their limited tools and did not consume too much of their scarce storage space.

³⁸ Ibid., 5, 33-34, 40-44. Turner cites 10 cents was the retail price for a can of tomatoes in 1909. This was affordable for a families who averaged spending \$10 on food per week.

³⁹ Ibid., 118.

⁴⁰ Ibid., 118-130, 165-175.

Turner expanded upon many of the findings in her dissertation in a chapter titled "Tools and Spaces: Food and Cooking in Working-Class Neighborhoods, 1880 - 1930" in Warren Belasco and Roger Horowitz's 2009 *Food Chains: From Farmyard to Shopping Cart*. The urban working-class engaged in a series of trade-offs: the need to eat, coupled with limited disposable income and inadequate tools, spaces, and services. The working-class conundrum was between "expending effort and spending cash when they provided food for their families."⁴¹ In her description of the working-class kitchen, Turner emphasized many of the older tools in them. Most stoves in working class homes were outdated wood or coal burning cast iron stoves. Besides requiring intensive maintenance, fuel hauling, and fire building, stoves caused the cramped multi-use kitchen to become extremely hot. There were few gas stoves until the 1910s or later, so the most common appliance in a working-class kitchen was a two burner portable stove, basically a hot plate, placed atop the cast iron stove or on a countertop. The portable stoves were designed to burn either natural gas or gasoline, and were useful for "heating a pot" and not much else.⁴² Although not suitable for producing an elaborate meal, the hot plates could be used to warm the contents of a can of baked beans. Turner's scholarship on the influence of material culture on food choices for urban working-class families demonstrates why canned goods were an important food source for city dwellers.

⁴¹ Katherine Leonard Turner, "Tools and Spaces: Food and Cooking in Working-Class Neighborhoods, 1880-1930," in *Food Chains: From Farmyard to Shopping Cart*, eds. Warren Belasco and Roger Horowitz (Philadelphia: University of Pennsylvania Press, 2009), 217.

⁴² *Ibid.*, 222-226.

Unlike the urban working-class, the middle-class of the early twentieth century saw canned goods as devices to bring convenience to the home and save time in meal preparation. In her 2000 *From Fireplace to Cookstove: Technology and the Domestic Ideal in America*, Priscilla Brewer argued that household technology, the cook stove in particular, was invested with meaning that transcended cooking. According to Brewer, "the cookstove has always been about more than just cooking." She contended it touched upon debates about the role of women, the meaning of the home, the impact of industrialization, the definition of social class, and the development of a consumer economy.⁴³ She used the cookstove as a cultural artifact to narrate her arguments about the changing social roles of middle-class women both inside and outside the home. The prospect of saving time in food preparation was important to early twentieth-century middle-class women as they had increasing activities outside the domestic sphere. Some women were employed outside the home, or participated in women's clubs or other social service organizations. They also employed less domestic labor than had their predecessors in the nineteenth century.⁴⁴ Brewer did not discuss the role of canned food, but the importance of saving time with food preparation using a modern cookstove is analogous to using canned food within an expanded scope of household food preparation technology. A major consideration for middle-class women of the early twentieth century when they purchased any type of household technology

⁴³ Priscilla J. Brewer, *From Fireplace to Cookstove: Technology and the Domestic Ideal in America* (Syracuse, N.Y.: Syracuse University Press, 2000), xv.

⁴⁴ *Ibid.*, 238.

was convenience and saving time for use in other activities.

The middle-class and rural working-class was the subject of Robert and Helen Lynd's monumental 1920s work *Middletown: A Study in Modern American Culture*. Their research was conducted Muncie, Indiana, certainly not a large urban metropolis like New York or Chicago, but their investigation did reveal the pervasiveness of canned food outside large cities. The Lynds made several interesting observations about canned food. First, the common canned items found in some Muncie kitchens were milk, beans, tomatoes, fruit and various jellies.⁴⁵ These findings were consistent with the leading canned products of the day. Second, less time was spent on cooking in the 1920s than 1890s, and the meals were less elaborate. Muncie residents sought convenience so that more time could be spent on other activities.⁴⁶ Finally, canned goods were popular because they provided more variety for medium and low income families during the portions of the year when fresh foods were unavailable or very expensive. Home canning was popular with medium and low income families for items such as tomatoes, fruits, and jellies. Despite the convenience, variety, and affordability offered by canned foods, the Lynds found some housewives felt guilty about feeding their families out of cans. They mentioned, however, that housekeeping magazines had tried to assuage this guilt and thereby enabled a significant change in American dietary habits.⁴⁷ The case of Muncie is illustrative of the factors drawing Americans, whether

⁴⁵ Robert S. and Helen Merrell Lynd, *Middletown: A Study in Modern American Culture* (New York: Harcourt, Brace and Company, 1929), 62-63, 155-156.

⁴⁶ *Ibid.*, 154, 156-157.

⁴⁷ *Ibid.*, 155-158.

they lived in large cities or small towns, to canned food.

The demographic shift from rural areas to large cities affected demand for canned foods. There were certainly cultural considerations, such as for Italian immigrants in Buffalo, New York, that influenced some ethnic groups to reject canned foods. However, for the most part, canned foods enjoyed an enthusiastic reception in large and small cities. Both the working' and middle-class purchased canned foods, but for different reasons. For the working-class, canned foods were affordable, offered undreamt of variety in what they could eat, and were amenable to their cramped living quarters and small kitchens. The middle-class also appreciated the variety of choices, but seemed to place a premium on convenience. Less time was spent in the early twentieth-century middle-class homes preparing meals because women were now often out of the home and either working or engaged in a myriad of social pursuits. In short, canned foods became more popular because they fit the lifestyles, expectations, and demands of working' and middle-class urbanites. Canned foods were a preferable choice for urban consumers compared to other food preservation methods and were at the center of Cowan's "consumption junction."

The Application of Science to Canning

Science became more important to canning and the can manufacturing industry in the late nineteenth century. Science was not, however, a causative phenomenon that was a prerequisite for increasing demand for canned food among a skeptical public. It is best considered an element of the maturation and professionalization of both the

canning and can manufacturing industries. Science had tentative roots in the canning industry in the early nineteenth century. Sir Humphrey Davy, an English chemist, discovered in 1808 that calcium chloride added to water could increase its boiling point. This discovery was not applied to the canning industry until 1861 when Isaac Solomon of Baltimore immersed his canned goods in a water bath treated with calcium chloride. The result was higher temperatures and decreased processing time for his goods, thereby increasing the throughput on his canning line dramatically. However, the calcium chloride corroded the tin coated cans, so a better method for processing cans was required by the industry. The invention of the steam pressure retort in 1873 by Baltimore canner Andrew Shriver revolutionized canning, and modern versions of his machinery are still used by canneries today.

Also in the 1860s, Louis Pasteur began his nascent experiments in bacteriology. Pasteur's basic research held great promise for the industry. His interest was the preservation of wine through a process of heating. Pasteur began his investigation into the microbiology of wine in order to understand the nature of the product. He drew air from the atmosphere and then passed it through filters made from guncotton. The filters were dissolved in a mixture of ether and alcohol, and he always found tiny spores of bacteria. The spores were then infused into sterile flasks of wine, and the wine quickly putrefied. Pasteur hypothesized that the spores were the root cause of spoilage and that application of sufficient heat could kill the bacteria, while not degrading the quality of the wine. He later acknowledged that he merely made a "new approach of

Appert's work" through the application of heat, but he had reached an important scientific conclusion. The cause of spoilage and putrefaction in canned or bottled goods was not exposure to air, but the bacteria ever present in the environment.⁴⁸ His conclusion was that the bacteria could be eliminated through thermal destruction, but he recognized that different foods required dissimilar amounts of heat because of differing types of bacteria. Additionally, cooking foods too long may remove harmful bacteria, but the "desirable properties" of these foods also were destroyed by lengthy cooking.⁴⁹

Before Pasteur, guesswork based upon trial-and-error was the norm in the canning industry. Cannerymen were also extremely secretive about the best heat and exposure time in the water bath to preserve various foods. According to the National Canners Association, "this rule-of-thumb procedure governed the industry for more than eighty years before the scientific basis of canning was worked out."⁵⁰ After Pasteur, there was a slowly growing realization in the canning industry that bacteria were more than just causes of sickness and disease, and that they may be the potential basis for spoiled canned goods.⁵¹

Despite Pasteur's discovery of the basic science behind fermentation and his process of "Pasteurization" to kill bacteria in the 1860s, it was over thirty years before bacteriology was applied to canning. The prevailing theory of mysterious spoilage in

⁴⁸ Thorne, *The History of Food Preservation*, 140-143.

⁴⁹ Stanley Sacharow and Roger C. Griffin, *Food Packaging: A Guide for the Supplier, Processor, and Distributor* (Westport, Conn.: AVI Publishing Company, 1970), 69.

⁵⁰ NCA, *The Story of the Canning Industry*, 2.

⁵¹ May, *Canning Clan*, 98.

canned goods during the early and mid-nineteenth century was still thought to be exposure to air. It was hypothesized that "total exclusion of atmospheric air" and application of sufficient heat applied would sterilize the contents of the can. The concept, known as the "vacuum theory," was coined by Dr. Jacob Bigelow in his 1830 treatise "The Elements of Technology."⁵² Yet in the immediate aftermath of the Civil War, canners were "groping in the dark for those invisible devils" that spoiled their canned goods. Knowledge of what ruined canned food was unknown to the majority of canners. Most new entrants into the booming industry knew little about processing and relied upon the advice of "expert" processors, but many of the supposed experts were extremely secretive about their process and had limited scientific training themselves. *McClure's Magazine* in 1914 described the lack of a scientific foundation in canning in the 1870s and noted that most processors did not know "a chemical symbol from a telegraph-pole." The result was a plethora of canned goods that swelled, the ends bulging outward shortly after packing. There were large losses of canned goods in all canning regions - East, Midwest, and the Pacific Coast. One Cincinnati processor noted that his entire pack of peaches "tasted the way a barroom smells - alcoholic."⁵³ Thankfully, most of the miscues were caught in the factory and were not distributed to the public. The recognition that very specific cooking times, kettle pressures, and temperatures were needed to destroy the bacteria causing spoilage, swells, and

⁵² W. Lyman Underwood, "Incidents in the Canning Industry of New England," in *History of the Canning Industry*, ed. A. I. Judge, 14.

⁵³ Woolley, "Tin Canners," *McClure's*, 73.

putrefaction was not recognized throughout the industry until the 1890s.

The science of bacteriology was first specifically applied to canning in 1895 by Dr. Harry L. Russell of the Wisconsin Agricultural Experiment Station, who had studied bacteriology at the Pasteur Institute in Paris. He was contacted by the Albert Landreth Company of Manitowoc, Wisconsin, a pea canner, alarmed about the extreme number of swells that occurred in their factory during the 1894 packing season. The factory superintendent, James Brooks, had been awakened in the middle of the night by pea cans exploding. Russell's assignment was to determine the cause of the spoilage. He opened a can of swelled peas, placed the product under a microscope, and found millions of bacteria spores. Russell found one bacteria in particular that would grow even in the absence of air. He presented his finding to the chief processor at the plant, Francis Patterson, and inquired about his processing settings. Typical of many nineteenth-century canners, Patterson's process settings "were his own well kept secrets" and "he did not believe in written records."⁵⁴ Patterson revealed he had cooked the peas under 10 psi, for 26 minutes, and at 232° Fahrenheit, not enough processing evidently to kill the bacteria.

Russell studied records of the 1894 pack and determined that processing times, pressure, and temperature were all interrelated. He proposed a series of experiments that gradually increased the pressure in the retort, elevated the temperature, and extended the cooking time slightly. Russell finally settled on a kettle pressure of 15 psi,

⁵⁴ May, *Canning Clan*, 31-33.

temperature of 242° Fahrenheit, and extended the cooking time to 30 minutes. He conducted a controlled experiment of 6,175 cans at Patterson's setting and 11,859 cans at his proposed settings. The experiment resulted in 306 failed cans at the usual process rates, a failure rate of nearly 5 percent; Russell's settings resulted in only 8 failed cans, a failure rate 0.07 percent.⁵⁵ Russell's experiments reduced the financial loss for the Albert Landreth Company and also increased their plant capacity by nearly 5 percent. More importantly for the industry, Russell applied the knowledge of bacteriology to canning for the first time and demonstrated that exact settings for pressure, temperature, and cooking time destroyed bacteria and minimized losses from improperly sterilized cans. Bacteria resistant to low temperatures, pressures, and short cook times were the problem, not exposure of the contents of a can to air as prescribed by the "vacuum theory."

At nearly the same time, two professors at the Massachusetts Institute of Technology were conducting experiments on the bacteriology of canned foods. Whereas Russell had been contacted by a canner and investigated a specific problem, Professors Samuel C. Prescott and W. Lyman Underwood studied bacteriology and its relationship to canning as an academic research project. Underwood was the grandson of William Underwood, who was one of the first canners in Boston during the 1820s. Prescott and Underwood conducted a series of experiments beginning in 1896 which sought to identify the effect bacteria had on the canning process. The subject of their

⁵⁵ Thorne, *The History of Food Preservation*, 144-145.

first study were canned clams and lobster, and "in every case where spoiling had occurred, living bacteria were present in great numbers. In sound cans, on the other hand, no living bacteria could be detected, and the contents proved to be sterile."⁵⁶ They found nine different types of bacteria in the clams and lobster, and discovered that four of them would survive in under-processed cans of food. To confirm their findings, they pierced and injected non-spoiled cans of food with the bacteria and, as a control, pierced other cans and quickly resealed them. The cans injected with the resistant bacteria soon spoiled, while the control cans did not. Their conclusion was that bacteria caused spoilage and exposure to air itself was not enough to cause deterioration. Their paper was published in the journal *Technology Quarterly* in 1897, and they were invited to speak to the Atlantic States Packers' Association the same year.⁵⁷ Unlike the commercial research of Russell, their work received wide dissemination, undoubtedly the Underwood name was a factor, but also because the east coast remained the locus of the industry.

In 1897 Prescott and Underwood next investigated sweet corn. A new type of deterioration had been found in corn in 1878. Even though the ends of cans did not bulge, and the contents smelled and appeared normal, the corn's taste was bitter and acidic. The investigators determined that the altered taste was the product of lactic and acetic acid formed through bacterial action. Their conclusion was that air did not cause

⁵⁶ Samuel C. Prescott and W. Lyman Underwood, "Micro-organisms and Sterilizing Processes in the Canning Industry," reprinted in A. W. Bitting, *Appertizing or The Art of Canning; Its History and Development* (San Francisco: The Trade Pressroom, 1937), 53. This paper was presented to the Society of Arts in Boston.

⁵⁷ May, *Canning Clan*, 98-100; Thorne, *The History of Food Preservation*, 145-146.

the deterioration and that "sterilization, not the driving out of air, is the important factor in keeping all kinds of foods."⁵⁸ They had definitively refuted the "vacuum theory" of spoilage. In 1898 they began experiments to determine what temperatures were required to preserve the taste of corn. Their hypothesis was that the contents of the can were not uniformly heated during processing. Their conclusion was that even if the maximum heat reached in the retort was 246° Fahrenheit, spoilage still occurred unless the center of the can attained the maximum temperature for a period of five minutes. Essentially, they proved that heating the center of the can to a prescribed temperature was more important than monitoring the vessel temperature. There was a relationship between temperature in the retort, the center of the can, time at maximum temperature, and the existence of bacteria.⁵⁹ The pair addressed the Atlantic States Packers' Association annually and published their findings. According the industry observer Earl May, the work of Prescott and Underwood was "a first step which eventually led to the removal of guessing from most factories' processing programs. It was also the beginning of the last stage of technical secrecy in our canning industry."⁶⁰

The pioneering work of Russell, Prescott, and Underwood was undertaken at the behest of cannery owners or because of academic interest in a problem for the canning industry, not complaints from consumers. The findings and conclusions from their work, however, certainly fulfilled customer expectations to purchase canned goods properly

⁵⁸ Thorne, *The History of Food Preservation*, 146-147.

⁵⁹ *Ibid.*, 147-149.

⁶⁰ May, *Canning Clan*, 105.

sterilized and almost certainly allayed lingering fears about canned foods. The veil of secrecy surrounding nineteenth-century canning had been lifted.

After 1900, private and public laboratories quickly sprang up around the country. The first private laboratory was opened in 1903 in Aspinwall, Pennsylvania, and was operated by E. W. Duckwall, who specialized in canning issues, such as proper packing procedures for certain products and causes of spoilage. The American Can Company opened a laboratory in 1906 and was soon followed by the Continental Can Company.⁶¹ The National Cannery Association opened a laboratory for members in 1913 in Washington, D. C., and followed with similar facilities in Seattle in 1919 and San Francisco in 1926. The United States Department of Agriculture also operated a laboratory staffed with chemists. The purpose of these laboratories was to investigate causes of spoilage in canned foods and publish bulletins to the field on proper methods, processing times, and temperatures for a wide variety of canned foods.⁶²

There was also a small cottage industry of canners who published trade magazines, books, and manuals for use by other canners. Two trade magazines in the late 1880s, *The Canning Trade*, known simply as *The Trade*, and *The Canner and Dried Fruit Packer*. These publications contained some information on bacteriology but were primarily concerned with crop reports and commercial matters. The books and manuals included specific instructions on how to prepare and process virtually any product in a tin can. An English translation of a work by French author Jean Packrette published in

⁶¹ Thorne, *The History of Food Preservation*, 151.

⁶² NCA, *The Story of the Canning Industry*, 2-4.

the 1890s contained "concise detail" on how to process various vegetables and fruits. In 1902, C. A. Shinkle offered a manual that "appears to offer to the American canner, pickler and preserver a nearer answer to his demands than anything that has yet to appear."⁶³ The most important of the early processors' manuals was "A Complete Course in Canning" by Edward S. Judge, editor of *The Canning Trade*, published in 1903.⁶⁴ This manual, used extensively by many canners including Henry Mill of Springtown, Pennsylvania, included cook times and temperatures for many products. Later processor manuals were written by Arvill and Katherine Bitting in 1916, *Canning and How to Use Canned Foods* and a companion piece in 1937 by A. W. Bitting titled *Appertizing or The Art of Canning; Its History and Development*. By the first decade of the twentieth century, laboratories and processing manuals, based upon the scientific discoveries of Pasteur, Russell, Prescott, and Underwood, were readily accessible or available to American canners.

Science had replaced guesswork and trial-and-error methods in the canning industry in the early twentieth century. Investigating a canning problem and disseminating this solution throughout the industry provided a foundation for future growth. Science reduced the number of spoiled cans at a packer's factory, thereby decreasing his costs, and improving product quality. It established standards for processing throughout the industry, and dissemination of these standards lifted the

⁶³ Edward S. Judge, "The Past, Present and Future of the Canned Food Industry," in *History of the Canning Industry*, ed. A. I. Judge, 58.

⁶⁴ Ibid.

nineteenth-century veil of secretiveness. Secondly, it reassured those consumers who remained skeptical of canned foods. However, science was neither an antecedent condition nor a causative prerequisite for industry growth. The data in Chart 6.1 indicate that demand for canned food had been growing in the United States before the use of scientific methods. The incorporation of science is best viewed as an added element of maturation and professionalization in the canning and can manufacturing industries. Identification and resolution of problems improved quality, assured continued growth, and reduced costs for canners which were passed along to consumers. Addressing consumer concerns was an important and significant secondary benefit of science.

The Pure Food Movement

The United States government also sought to assure Americans of the safety of their food supply with the enactment of the Pure Food and Drugs Act in 1906. The groundwork for the crusade against adulterated foods had its roots in the immediate post-Civil War era. In his 1986 book, *Fair Play in the Marketplace*, historian Mitchell Okun argued that the battles over adulteration from 1865 through 1886 were the origins of the consumer movement and the foundation for the Pure Food and Drugs Act. These nineteenth-century debates, according to Okun, anticipated the issues, arguments, and in many cases the solutions to reassure Americans of their food

supply.⁶⁵ The nineteenth-century debate revolved around foods of all types -- meat, milk, sugar, oleomargarine, coffee, and patent medicines. At that time, canned goods were only a peripheral issue. Accusations about the "deleterious" effects of canned foods sometimes surfaced in the press, yet some members of the scientific community and the "grocery press" came to their defense. In 1882, S. A. Lattimore, a chemist from Rochester, New York, studied suspected cases of "poisoning" from canned foods and found "no evidence of adulteration or of harmful qualities in canned fruits and vegetables." Professor A. H. Chester studied canned meat and found nothing wrong with the canning process itself, but he did express concern about the quality of the raw ingredients. As canning was a relatively new food preservation process in the 1880s, some suspicions prevailed amongst the public. The trade publication *American Grocer* assiduously defended canned foods as they were becoming a much larger proportion of a grocers' revenue. It attacked any public cases of adulterated canned fruits and vegetables, as well as legislative measures aimed at canned foods. The attempt by the New York Mercantile Exchange to prohibit "the sale of canned goods under fictitious labels" was a focal point of the *American Grocer's* efforts to support the industry. The publication argued that the bill was actually intended to keep goods from other states from reaching the New York market. A bill was eventually passed in New York, to take effect on January 1, 1886, that required canners to label their goods with the name and address of the canner in the state, or the wholesaler if the goods were from out of

⁶⁵ Mitchell Okun, *Fair Play in the Marketplace* (Dekalb, Ill.: Northern Illinois University Press, 1986), ix.

state.⁶⁶ This measure was rather benign and proved to be no great burden on the industry.

While there were concerns about adulterated foods, there was no nationwide movement against them in the nineteenth century. The more localized debates of the 1870s and 1880s, however, persisted for the balance of the century and contributed to the passage of the Pure Food and Drugs Act in 1906. According to Lizabeth Cohen in her 2003 work, *A Consumers' Republic*, the Act was an example of a "first wave consumer movement" demonstrating the centrality of consumers to the economic health of the nation. The shift from a producer oriented economy to one where the consumer was at the center, was a twentieth-century phenomenon.⁶⁷ Although her treatment of early twentieth-century consumer movements was limited, it was during that period when two types of consumers came to the forefront of American economic and political activity. There were "citizen consumers," those who safeguarded the general good of the nation and supported government efforts to protect consumer rights in the marketplace, and "purchaser consumers" who exercised their preferences through the purchase of goods in the marketplace. Cohen argued that mass consumption, the production, distribution, and purchase of brand-name goods by the general public, became prevalent during the 1920s.⁶⁸ The crowning achievement of Cohen's early "citizen consumers" was the passage of the Pure Food and Drugs Act.

⁶⁶ Ibid., 242-243.

⁶⁷ Lizabeth Cohen, *A Consumers' Republic: The Politics of Mass Consumption in Postwar America* (NY: Random House, 2003), 21.

⁶⁸ Ibid., 18, 22.

The Pure Food and Drugs Act is rightly viewed as a victory for consumers, but many canners also supported the Act, albeit for different reasons. The chief enforcer of the Act was Dr. Harvey W. Wiley, the chief of the Chemical Division for the U. S. Department of Agriculture. Wiley had been a leader and proponent of the anti-adulteration movement in the 1880s. He had his staff prepare a study of food adulteration in the mid-1880s, published it in 1887, and eventually it grew to eight volumes. The study, *Bulletin 13 - Food and Food Adulterants*, was regarded as the most complete manual on the subject up to 1906.⁶⁹

Given low costs of entrance for canning, many new market participants "were tempted to make larger profits by cutting the cost of assembling raw materials and canning them."⁷⁰ These actions could undermine the reputation of the entire industry. Not only did the industry suffer from bad press, it also feared for its continued growth. In February 1906, Wiley made a speech to a convention of canners in Atlantic City, New Jersey. As a result of his speech, the canners adopted a resolution supporting national legislation for canned food standards. The passage of the resolution was primarily driven by the fruit and vegetable canners. This was because adulteration was fairly uncommon in canned fruits and vegetables. The canners asserted that national legislation "would benefit consumers and canners" alike and urged "stringent" measures "capable of rigid enforcement."⁷¹

⁶⁹ Okun, *Fair Play in the Marketplace*, 285-286.

⁷⁰ May, *Canning Clan*, 321.

⁷¹ James Harvey Young, *Pure Food: Securing the Federal Food and Drugs Act of 1906* (Princeton: Princeton University Press, 1989), 176-178. While fruit and vegetable canners were generally supportive

The public concerns leveled against canned food were varied and centered on packing inferior produce and meat, misleading labels on cans, and the hazardous effects of materials used in the construction of a tin can. Complaints in the immediate post-Civil War period alleged inferior goods were packed in cans and the weights were often overstated as water comprised a greater proportion of the contents than the fruit or vegetable in the can. The infamous "embalmed beef" scandal during the Spanish-American War in 1898 captivated the public imagination, but canned meat was eventually found not to be a culprit of any illness in soldiers and sailors.⁷² "Bleaching" corn with "sulphite of sodium" to preserve its color, untruthful listing of contents on labels, and no uniform standards for grading the quality of fruits or vegetables contained in the can were frequent complaints later in the nineteenth century.⁷³ There were also concerns with the materials used in making the can. As early as the 1870s, it was alleged in a report by the Metropolitan Board of Health in New York City that canned vegetables "may" be contaminated with lead. After a brief two-sentence discussion, the topic was dropped and not commented on further.⁷⁴ In the 1880s, tinsmiths displaced by "machine-made" cans argued that the zinc chloride used in solder flux was deleterious to health, so canners stopped using this material.⁷⁵ The most serious charge, from the can-makers' perspective, was made by Wiley in 1906. He

of federal standards for the industry, meat packers were not and continued to be denigrated in the public sphere.

⁷² Ibid., 107, 135-139.

⁷³ May, *Canning Clan*, 321-324.

⁷⁴ Okun, *Fair Play in the Marketplace*, 48.

⁷⁵ Ibid., 110.

believed that the tin coating on the steel used in can manufacture dissolved into the product and contaminated it. Experiments conducted by canners' trade associations eventually proved this to be an incorrect assertion.⁷⁶ Canners recognized there were external forces arrayed against them, but more importantly, they believed as a group that unscrupulous canners who did not follow proper canning methods, used inferior raw products, or mislabeled their cans were the greatest threat to their livelihood.

The solutions proposed in the Pure Food and Drugs Act in regard to canned food were seemingly benign and not a hindrance to the fruit and vegetable canning industry. However, packers fought government efforts to mandate dating of cans. It was believed by some packers that the public might not purchase cans with an older date when a more recent one was available, even though the older cans were still fit for consumption. The dating provision was dropped, but the final version of the Pure Food and Drugs Act suggested accurate listing of contents and weights on cans. Even this provision was made optional. The final bill stipulated that if a canner listed the contents and weights on their label, it must do so "accurately." Congress believed that competition from reputable canners would force those that did not label to do so.⁷⁷

Canners, at least fruit and vegetable packers, were generally supportive of the Pure Food and Drugs Act because it set minimum standards for the industry. Many canners were worried about the reputation of the industry and believed that some federal and state legislation was necessary. They believed that competition alone was

⁷⁶ May, *Canning Clan*, 325-338.

⁷⁷ Young, *Pure Food*, 238-263.

not enough to keep disreputable canners from distributing products of questionable quality. Yet, the canning and can manufacturing industries continued to battle what they thought were false claims about the safety of canned food, despite the growth of the industry and increasing consumption by the public. There was growing consensus among many regional canning associations, such as the Western Packers' Canned Goods Association, the California Fruit Canners' Association, and the Atlantic States Packers' Association, that an effective national voice was needed to lobby for the industry. It is not mere coincidence that the first national canning industry trade association, the National Canners Association, was founded less than a year after the passage of the Pure Food and Drugs Act. The industry required a strong voice in legislative matters and an instrument for education.

Trade Associations

The National Canners Association (NCA) was founded in 1907 from the Atlantic States Packers' Association, the largest of the regional canner organizations. As the canning and can manufacturing industries were concentrated on the east coast, the NCA looked outside their traditional region for their key leadership positions, in order to broaden their membership and national appeal. One of the first leaders of the NCA was Charles S. Crary, a Wisconsin tomato canner, who was president from 1907 until 1909. The organization became, by 1914, the most important trade association for canners and can-makers, although it had no interest in commercial matters, such as setting

prices.⁷⁸ The name was somewhat misleading, however, as members were drawn from not only food canners, but can manufacturers, seed growers, and canning equipment suppliers. In short, if your business touched the canning industry, in either a direct or peripheral manner, this was your trade association. The American Can Company and Continental Can Company were early supporters of the NCA, particularly its research activities. Supporters also included smaller packers, such as the Edgett-Burnham Company of New York and the H. S. Mill Canning Company in Springtown, Pennsylvania.⁷⁹

The initial goal of the NCA was to support canners and allied industries by challenging bad publicity about the industry in the national press. In 1909, one of their first actions was creation of a program designed to "counteract falsehoods about canned foods." The "falsehoods" were reports in popular media concerning the safety of canned foods and general "public misinformation."⁸⁰ Any story or incident reported in the press, throughout the country, about sickness or "poisoning" attributed to canned foods was investigated by employees of the NCA, or even hired detectives. A 1914 article in *McClure's Magazine*, noted that the association's primary mission was "to kill the slanders[sic], current since the days of William Underwood, on canned foods." Edward Mott Woolley, the author of the *McClure's* article provided several examples of the NCA's primary mission. In Oklahoma in 1913 a man died after eating a can of

⁷⁸ CMI, *The History of the Metal Can*, 8; May, *Canning Clan*, 104, 297; Woolley, "Tin Canners," 74.

⁷⁹ McKie, *Tin Cans and Tin Plate*, 246, 256; Pound, *Industrial America*, 101.

⁸⁰ CMI, *The History of the Metal Can*, 8-9.

sardines. Frank Gorrell, the secretary of the NCA, investigated the incident and found that the man's wife had placed arsenic in the can. In Marion, Indiana, a woman died of "ptomaine" poisoning after eating canned tomatoes. Detectives found she had committed suicide. In Ohio, forty people became sick after dining at a restaurant and two of them eventually died. This incident received wide publicity in the national press and the supposed culprit was canned foods. An NCA investigation produced an eighty-four page report that concluded the cause of the sickness was contaminated rice pudding. After these sensational incidents were proved by the NCA to be false, Woolley believed "the newspapers are learning to be cautious and fair and to know before they print."⁸¹

The NCA continued to investigate consumer claims for decades. Upon the death of President Harding in 1923, there were rumors that the late president died because he ate contaminated canned food. Frank Gorrell of the NCA sent a letter to the White House physician, Dr. C. E. Sawyer, and requested he comment upon these reports because of "serious concern in the canning industry." Sawyer answered that "President Harding's primary illness was not due to eating canned foods."⁸² The NCA had vindicated the canning and can manufacturing industries in this high-profile case. In a 1963 interview, Kenneth M. Ingison, the sales manager since 1935 for the Fruit Belt Preserving Company of Sodus, New York, recounted two cases the NCA examined for them. In one incident a customer claimed to have found a pen inside a can and in

⁸¹ Woolley, "Tin Canners," 74-76.

⁸² *New York Times*, 1 September 1923, p. 11.

another a rodent. Upon a search of the cannery, it was discovered that no pens were used at this cannery, and the rodent was not cooked, therefore it had not been in the can. Ingison also noted that consumer claims spiked during "hard times."⁸³ Given the period in which the NCA was created, it should not be surprising that their primary mission was to improve the public image of canned foods by investigating and fighting consumer claims. However, this was a defensive action and represented only a portion of NCA activities. The NCA supported the industry through offensive actions, such as research and education.

Research into the science of canning was also an NCA activity within a few years of their founding. By 1920, the organization had three divisions or bureaus: conservation, chemical research, and education. The purpose of the newest division, the conservation bureau, was devoted to "the scientific development of the sources of food supplies," according to Walter Sears, the president of the NCA in the late 1910s. This division studied seeds and varieties of fruits and vegetables to determine what species were most amenable to canning. It was a joint undertaking between canners, farmers, and agricultural bureaus.⁸⁴

The chemical research division was established within a few years of the NCA's organization, and according to Sears, "has already performed a great service for the industry." The chemical research division was a platform for further development of the

⁸³ "Kenneth M. Ingison Oral History Manuscript," interview by Dr. George Hucker, September 1963, New York State Food Processing Industry Oral History Project, Archive #2378, Transcript #1203, 15-17.

⁸⁴ Walter J. Sears, "The Farmer and the Canner," An Address Given in Chicago, Illinois to the Western Canners Association on April 15, 1920, 8.

scientific studies of Russell, Prescott, and Underwood. It examined and solved "new problems" of the industry and established a nationwide network of research laboratories. The division often collaborated with leading scientists, scholars, and universities to investigate "ptomaine poisoning" and botulism.⁸⁵ In 1913, the NCA engaged Dr. Bronson Barlow of the University of Illinois to study "heat-loving" bacteria. Dr. Barlow found that there were certain strains of bacteria capable of living at temperatures of 150-160° Fahrenheit, confirming the earlier research of Prescott and Underwood. Barlow's work also provided additional substantiation for skeptical canners that exclusion of air was not the reason for spoiled canned goods. Another early project, in 1917, was conducted between the NCA and Dr. M. J. Rosenau of Harvard University on bacteriology in canning and "ptomaine poisoning." Dr. Rosenau found that bacteria and the resulting botulism, not "ptomaine poisoning," was responsible for spoilage in improperly processed canned goods.⁸⁶ The basic science of Barlow and Rosenau was used in later heat study investigations. In 1917 and 1918 the NCA worked with the American Can Company and steel manufacturers to determine standard types of tin plated steel to use for proper heat penetration into the center of a can. The experiments, conducted under the direction of Dr. Willard D. Bigelow, the director of the NCA's research laboratories, was published by the association's Washington, D. C. laboratory in 1920 under the name "Heat Penetration in Processing Canned Foods" and provided canners "safe times and temperatures" to be used for processing a wide range

⁸⁵ Ibid.

⁸⁶ NCA, *The Story of the Canning Industry*, 2-4; CMI, *The History of the Metal Can*, 8.

of products. As a result of these studies and their dissemination to the industry, there were no reported cases, after 1925, of botulism traceable to commercially canned foods.⁸⁷

In addition, the NCA published educational materials for both industry and the public. According to Walter Sears, the education division's purpose in 1919 was to "find the scientific basis for the preparation of clean and wholesome canned foods, and to win for these foods the favorable opinion of the people." The activities of the education division rested upon inspection of canneries and public education. Those canneries that passed a sanitary inspection by the NCA were issued a "seal of inspection," which was then used in advertisements, other promotional activities, and was placed on the can labels of the approved cannery. Sears noted that a similar campaign to inspect and certify raisins, oranges, and lemons in California had greatly increased sales of these products.⁸⁸ Educational activities took many forms and were the forerunner of an aggressive industry-wide advertising campaign in the 1920s. The NCA published numerous technical bulletins for members, such as Dr. Bigelow's "Bulletin Number 2, Swells and Springers (1914)." Bigelow explained the difference between a swell, "decomposition accompanied with generation of gas due to defective sterilization or a leaky can," and a springer, "ends bulging due to pressure from hydrogen from an interaction of the product and metal."⁸⁹ His purposes were to demonstrate that

⁸⁷ May, *Canning Clan*, 163-166, 320; NCA, *The Canning Industry*, 8.

⁸⁸ Sears, "The Farmer and the Canner," 8-9. The education division was organized in 1919.

⁸⁹ W. D. Bigelow, "Swells and Springers," Bulletin No. 2, August 1914, Research Laboratory National Canners Association (Baltimore: The Lord Baltimore Press, 1914), 3.

bacteria, and chemical reactions, occurred within a can, and to inform his readers how to prevent them.

In 1914, the NCA published a history of the canning industry as a "souvenir" for its members who attended the annual convention in Baltimore. Edited by Arthur I. Judge, *A History of the Canning Industry by its Most Prominent Men* provided members and the general public with histories that covered regional canning development, equipment and machinery, solder making, and labeling of cans. In 1923 various studies on the nutritive properties of canned foods were conducted by NCA chemist Dr. E. F. Kohman and were given wide publication and dissemination.⁹⁰ Other important NCA publications were the annual *Canners Directory* listing canning companies and their products, can manufacturers, and equipment suppliers. For the general public *The Canning Industry*, a collected series of articles, informed readers about the methods, products, history, and organization of the industry.⁹¹ Other services provided by the NCA included support of the War Industries Board in World War I, standardized can sizes, improved labeling compliant with the Pure Food and Drugs Act, testing of recipes used in school lunches, "interpretation of the results of research on canned foods for homemakers," and uniform grading protocols for fruit and vegetable products.⁹² Interestingly, formal lobbying of Congress and other lawmakers was not a primary function of the NCA during its first twenty-five years of existence.

⁹⁰ NCA, *The Story of the Canning Industry*, 4-5.

⁹¹ *Ibid.*, 8.

⁹² May, *Canning Clan*, 374-378; NCA, *The Story of the Canning Industry*, 7.

The National Canners Association was formed as a reaction to the Pure Food and Drugs Act in 1906, and also because the canning and can manufacturing industries recognized they needed a more effective national organization, rather than just regional associations. While the NCA's initial mission was defensive in nature and intended to preserve the status of the industry and counteract negative publicity about canned foods, it soon embraced pro-active actions. Focused research on canning, establishment of national laboratories, publication of technical data to canners, educational literature for the public, investigations into improved hybrid seeds, and many other activities were pro-active in nature and designed to improve the image of and expand the market for canned foods. The early activities of the National Canners Association are also examples of institutionalization, which is a function of the growth, maturation, and professionalization of the canning and can manufacturing industries.⁹³

Advertising

Advertising was undertaken by many members of the canning and can manufacturing industries in the early twentieth century to expand the market for canned foods and secondarily to reassure customers. In *Never Done: A History of American Housework* (1982), Susan Strasser dedicated an entire chapter to advertising and distribution titled "Selling Mrs. Consumer." Strasser discussed the rise of the

⁹³ The NCA continued to be the foremost lobbying organization for the canning industry for the balance of the twentieth century, but changed its name over the years to be more inclusive of all food processors, not just canners: National Food Processors Association (1978) and Food Products Association (2005). The FPA merged with the Grocery Manufacturers Association in 2007. A separate trade organization for can-makers was formed in 1938, the Can Manufacturers Institute, and this body is still in existence. (Based upon the author's industry experience)

consumption ethic and argued that advertising and advice literature stressed the roles of economical household operations by the woman of the house. According to Strasser, "women bought more machine-made products because they made life easier, not more complex, interesting, or inspiring."⁹⁴ She argued that "new products required advertising to create demand: consumers did not know they wanted or 'needed' products they had never seen." Canned food was not a "new product" by any means, but it was an early consumer product with a low unit cost. For these type goods, increasing demand could not be accomplished by canners or can manufacturers by lowering prices, because the prices were already relatively low. In order to spur demand, the industry had to "concentrate on ways of selling more of them to increase their profits. Advertising therefore developed in tandem with mass production,"⁹⁵ and advertising boomed in the 1920s.

In her 1976 essay in *Technology and Culture* titled, "The Industrial Revolution in the Home: Household Technology and Social Change on the 20th Century," Ruth Schwartz Cowan argued that technology changed the structure of housework and actually added new tasks, unlike industrial technological development of the late nineteenth century.⁹⁶ Cowan specifically mentioned canned foods, but noted that they were not an "appreciable" part of the middle-class diet until the 1920s. Nevertheless, canned foods provided variety and "an American housewife with sufficient means could

⁹⁴ Strasser, *Never Done*, 251.

⁹⁵ *Ibid.*, 252.

⁹⁶ Ruth Schwartz Cowan, "The Industrial Revolution in the Home: Household Technology and Social Change in the 20th Century," *Technology and Culture*, Vol. 17, No. 1 (January 1976), 1.

have purchased almost any fruit or vegetable and quite a surprising array of ready-made meals in a can."⁹⁷ Cowan used advertising copy, primarily from magazines directed at middle-class women, to discover themes prevalent in the 1920s. From her investigation, she argued that "large companies . . . Campbell's, Del Monte, American Can . . . were all well-established firms by the time the household revolution began, and they were all in a position to pay for national advertising to promote their new products and services." These national advertising campaigns were "powerful stimulators" of social change.⁹⁸ In the 1920s, advertising was embraced by canners and can manufacturers as a means to enlarge sales of canned foods. It also acted as a bridge between new or unfamiliar technologies, for some consumers, and the social transformations occurring in the American household.

The major can manufacturing companies, Continental Can and American Can, advertised extensively in the early twentieth century. Packaging suppliers, which did not provide a product or service directly to the consumer, advertised to encourage the use of their product. Before 1920 national advertising was a novelty, but it was quickly embraced by the Continental Can Company in the 1920s. Arthur Pound, who wrote in the 1930s, stated that, "Continental joined forces fully with the canners in these joint efforts to educate housewives to the advantages and merits of the more than three hundred kinds of foods and delicacies available at all seasons in tin cans."⁹⁹ Continental

⁹⁷ Ibid., 8.

⁹⁸ Ibid., 20.

⁹⁹ Pound, *Industrial America*, 105-106.

advertisements stressed the health, freshness, variety, and availability of canned foods. According to Pound, "housewives reacted favorably to the messages on the uses and merits of canned food."¹⁰⁰ The American Can Company also advertised to promote not only their main product, fruit and vegetable cans, but also other types of containers. In a 1927 trade pamphlet directed at hardware or retail outlets, American Can, also known within the industry as "Canco," extolled the virtues of their trash cans. The advertisement for Canco Rubbish and Trash Burners offered four sizes of trash pails ranging in size from 4½ to 12 gallons, and five sizes of trash cans from 11 to 33 gallons. The advertisement stated these were "popular" items due to the "remarkable increase in sales." The popularity of trash cans advised the retailer that "your stock is not complete without a full line of Canco Garbage Cans." As to the effectiveness of advertising, the pamphlet affirmed that "our advertising is helping in increasing demand."¹⁰¹ The advertisement implied that the prudent hardware store owner needed to have a "full line" of garbage cans for his customers.

Major canners and trade organizations, such as Del Monte, Heinz, and the National Canners Association, advertised to promote their products or the industry. In 1973, Alfred Eames, the chairman and CEO of the Del Monte Corporation, and Richard Landis, president, stated that Del Monte was the first canner to utilize national advertising. In the April 17, 1917 edition of the *Saturday Evening Post*, they claimed to

¹⁰⁰ Ibid., 106.

¹⁰¹ American Can Company, "American Can Company Trade Literature, 1927," Lake Mohonk Mountain House Collection, Hagley Museum and Library, Manuscripts and Archives Section - Soda House, Greenville, Delaware, Accession # 2280, Box 14, Folder 3.

offer "the first national ad for any fruit or vegetable." The advertisement was an illustration of a Del Monte can of peaches with the simple line "California's finest canned fruits and vegetables are packed under the Del Monte brand." During World War I, Del Monte stressed "patriotic" themes and urged "housewives" to can at home since the majority of commercially canned foods were sent overseas. During the Great Depression, Del Monte advertised extensively and targeted housewives with themes of affordability, dependability, quality, and nutrition.¹⁰² As noted in a previous chapter, the Heinz Corporation was also an early national advertiser. In the 1920s, Heinz continued to promote similar themes as they did in the late nineteenth century: "taste, variety, and overall quality." The Heinz "ambitious brand creation strategy," was built around "imaginative advertising."¹⁰³

The National Cannery Association and the Campbell Soup Company collaborated in a 1922 advertisement in the *Saturday Evening Post* celebrating National Canned Foods Week, March 1 to 8, 1922. The advertisement urged consumers to "visit your grocer's [sic], see his big display of canned foods and supply yourself liberally." The illustrations featured a large can of Campbell's soup, an open case of assorted soups, and a cherub-faced child holding a smaller box of soup. The campaign's use of Campbell's soup was ingenious because they were arguably the best known national brand of canned food in the 1920s. However, in the spirit of National Canned Foods

¹⁰² Alfred W. Eames, Jr. and Richard G. Landis, "The Business of Feeding the People: The Story of the Del Monte Corporation," An Address Given in San Francisco, California to the Newcomen Society in North America on November 7, 1973 (Princeton: Princeton University Press, 1974), 10-12.

¹⁰³ Nancy F. Koehn, "Henry Heinz and Brand Creation," 375.

Week, the copy in the advertisement touted fruits, vegetables, fish, and meat. Available at the local grocery store were "velvet, golden peaches, sun-ripened to juiciest sweetness and plucked for your table when the bloom is fresh upon them" as well as "the ruddiest of ripe tomatoes, flawless and appetizing." The seafood and meat were the "tastiest of fish, the choicest of meats." The advertisement also was intended to reassure customers with pledges of quality and purity; "canned foods are produced in an industry whose dominant note is quality -- an industry directed by experts and scientifically organized and equipped to supply foods which are the last word in delicious quality and strict purity." If consumers were not convinced to purchase canned foods with these assurances of freshness and quality, they were reminded of another positive attribute of canned foods, their convenience. In small print, below a life-sized illustration of a Campbell's soup can, the message read "it's so delightful and convenient to have these delicious foods right in your pantry all the time."¹⁰⁴

The desired target behind advertising in the early twentieth century varied, but was primarily directed at middle-class women. The Curtis Publishing Company, publishers of the *Saturday Evening Post* and *Ladies' Home Journal*, engaged Richard J. Walsh to write a book for them in 1913 that stressed the effectiveness of advertising in their periodicals. The purpose of Walsh's book, *Selling Forces*, was "to place in a convenient and readable form the actual facts about the advertising facilities which our

¹⁰⁴ National Canned Foods Week Advertisement, *Saturday Evening Post* (February 25, 1922), p. 25.

publications have to offer."¹⁰⁵ Most of the book contained information on development, efficiency, machines used for printing, agents, consumers, retailers, jobbers, and reasons for advertising. There was also a section on precise strategies to be used for target audiences, such as women, businessmen, and farmers.

The section on women and advertising is particularly interesting as this was the demographic specifically sought by canners and can manufacturers. According to the Curtis Publishing Company, women had a "trait of fine discrimination in merchandise," and conducted a "diligent search for best values." Women were "charged with the duty of spending 90 percent of family income," and "she buys the groceries." The Curtis Publishing Company also believed that "the home is her factory" and the place where "raw materials are being converted into finished products."¹⁰⁶ The balance of the section on advertising strategies for women extolled the virtues of the *Ladies' Home Journal* as the perfect medium for reaching middle class women: "to amuse, instruct, comfort and inspire the woman whose constant thought is to make a real home for her husband and children, that is the mission and the accomplishment of the *Ladies' Home Journal*."¹⁰⁷ The goal of the *Ladies' Home Journal* was "to make her housekeeping efficient," and "shape the thought of American women." Since the *Ladies' Home Journal* was a trusted source of information for middle-class women, "purchased eagerly" by almost two million women, and "read by them with the closest attention," it wielded

¹⁰⁵ Curtis Publishing Company and Richard J. Walsh, *Selling Forces* (Philadelphia: Curtis Publishing Company, 1913), 3.

¹⁰⁶ *Ibid.*, 229-230.

¹⁰⁷ *Ibid.*, 234.

“an influence in which the advertiser may share.”¹⁰⁸ Although many of these statements are hyperbolic or condescending by contemporary standards, the Curtis Publishing Company was correct that women managed much of the spending within the home in the early twentieth century. Therefore, women were an inviting target for canners and can manufacturers to market their products.

The psychology behind advertising in the early twentieth century differed little from what was later suggested to the American Can Company and the National Canners Association in the early 1950s. Dr. Ernest Dichter, a psychologist who conducted market research for clients, was engaged by the advertising agency Young and Rubicam in 1952 to improve the image of the American Can Company. Dichter suggested the agency stress the link between the tin can and "American progress," as well as themes of assuaging "guilt feelings" from the use of cans, with the idea that they offered "protection." He emphasized appealing to emotions to gain "trust," while they acknowledged "past problems" of tin cans. Dichter's major suggestion was again to establish emotional ties and link American Can with "the progress of the American people."¹⁰⁹ Dichter was hired by Young and Rubicam again in 1953 to conduct market research for the National Canners Association. In the introduction to his report, he stated that canned food "was one of the first time saving devices and thus it was eagerly accepted." Even in the 1950s, Dichter believed the NCA should demonstrate to "the

¹⁰⁸ Ibid., 235-238.

¹⁰⁹ Ernest Dichter, Ph.D., "Ernest Dichter Papers," Hagley Museum and Library, Manuscripts and Archives Section - Soda House, Greenville, Delaware, Accession # 2407, Box 10, "American Can Company," Reports 260E, 260.1E.

American housewife" that canned foods were one of the "oldest forms" of food processing and a format that had never been "duplicated by other methods." As far as specifics to use in advertising, he advised that the can should be "glamorized" and its time saving and protective properties accented, "a hull around the delicate, perishable food."¹¹⁰ What is striking about Dichter's suggested themes, such as "protection," "progress," "trust," "emotional ties," and "time savings" is that they were quite complementary to what canners and can manufacturers used in the 1920s.

The media format for advertising changed over time, but the themes remained remarkably consistent. Informational booklets were common in the 1890s. Alphonse Biardot, the owner of the Franco-American Soup Company, authored and published an informational booklet in 1897 titled *Franco-American Soups: How They Are Made*. The purpose was to inform the public about Franco-American products and convince consumers to purchase them. The target audience for Biardot's booklet was the upper-class or aspirational middle-class, as demonstrated by the illustrations. In the dining scenes, the women were dressed in fancy gowns, the men in formal coats with tails, and the domestic servants in less ostentatious attire. Other illustrations featured a luncheon party on a yacht with the line that Franco-American soups were the perfect food "while yachting, picnicing [sic], or camping out," and were an excellent choice "before retiring" when "coming home from the theatre." Their soups could also be used for entertaining,

¹¹⁰ Ernest Dichter, Ph.D., "Ernest Dichter Papers," Hagley Museum and Library, Manuscripts and Archives Section - Soda House, Greenville, Delaware, Accession # 2407, Box 10, "Canners Association," Report 283E.

especially when "an unexpected friend drops in when the dinner is only just sufficient for the family." The overriding themes in their advertisement booklet, however, were variety, convenience, quality, and freshness. The last few lines of the booklet stated that "the question of variety for lunch is a problem which our soups in half-pint cans have in part solved." Additionally, "the Franco-American Soups are convenient everywhere and at all times; they can always be relied upon, for their quality never changes; they will keep fresh and sound for any length of time so long as the tin remains unopened."¹¹¹ Many of these same themes would be used in the advertising of the first two decades of the twentieth century, but the format would change. Booklets, such as distributed by Franco-American, and pamphlets that American Can Company used for promoting their garbage cans were used infrequently. The preferred mode to reach more potential consumers were mass market periodicals, primarily those directed towards women.

Quality, variety, convenience, and affordability were the most prevalent themes in periodical advertising for canned foods in the early twentieth century. A 1905 advertisement in *Ladies' Home Journal* for Armour Beef Extract stressed economy, thrift, and nourishment. An illustration of a nineteenth-century stock pot adorned the top of the advertisement with the slogan that "the stock-pot is a sign of the thrifty housewife. It was the hall mark of the economical housewife. It meant there was no waste of food materials." The copy lamented the passing of the stock pot; "modern housekeeping has

¹¹¹ Biardot, *Franco-American Soups: How They Are Made*, 8-10.

crowded out the stock pot, and in many instances increased the table expenses." If a housewife purchased a can of Armour Beef Extract, she could make "delicious soup and bouillon . . . in a few minutes with it." By adding leftover "canned vegetables, rice, game, roast, etc.," the beef extract would "get the full nourishment out of them." Additionally, if you sent in a cap from a can of beef extract, the company would send you a recipe book, postpaid.¹¹²

In the first decade of the twentieth century, after passage of the Pure Food and Drugs Act, reassuring consumers of your firm's reputation was a common theme. In a 1907 advertisement in the *Ladies' Home Journal*, the Portland, Maine firm Burnham and Morrill Company, advised customers "Don't Trust to Luck in Ordering Canned Foods." Burnham and Morrill noted they had "fifty years' experience" in canning and that their aim was to "place our products on your table as pure and wholesome and rich in flavor as the day they were put in the tin." The company offered four products: Paris Sugar Corn, Extra Quality Baked Beans, Scarboro Beach Clam Chowder, and Scarboro Beach Clam Juice. The corn was "rich in sweetness," the baked beans made from "the choicest hand-picked beans, baked in the good, old New England fashion," and the clam chowder as "delicious a clam chowder as you ever ate at a seashore 'fish dinner.'"¹¹³ Reassuring customers of the safety of their products, quality, and freshness were the themes of Burnham and Morrill's advertising.

¹¹² Armour Beef Extract Advertisement, *Ladies' Home Journal*, Vol. 22, No. 11 (October 1905), p. 31.

¹¹³ Burnham and Morrill Company Advertisement, *Ladies' Home Journal*, Vol. 24, No. 4 (March 1907), p. 31.

While quality, convenience, affordability, and variety were powerful ideas, there were, however, several other prevalent themes. Borden Milk, later known as Eagle Brand, used a trope known as the "true story" where the virtues of their product were extolled in print with a testimonial from a consumer. Campbell Soup targeted upper middle-class and middle-class women with the "captivated child" where a youngster stared adoringly at a bowl of soup. They also appealed to the housewife with the "healthy lifestyle" theme where eating soup was a quick and convenient method to feed a nutritious meal to your family.¹¹⁴ An example of a Campbell Soup advertisement using the "healthy lifestyle" theme was in the February 6, 1915 issue of the *Saturday Evening Post*. A high quality lithograph of a young boy, chubby-faced, wearing a cowboy hat, kerchief and holding a cap pistol, leaning atop a crate of Campbell's soup, was at the top of the advertisement. Below this picture was the slogan "Well Fortified." The text of the ad read "Fortified inside as well as out. You can see this by his well-chosen bulwark of defense [the Campbell's soup crate]." His mother evidently was one of those sensible housewives who ordered Campbell's soup by the dozen or the case. Buying in bulk was "practical" because it "saves your time," eliminated "bother and delay," guaranteed you "a delicious nourishing soup-course every day," and "you are fortified against all sorts of emergencies." All twenty-one soups offered by the Campbell Soup Company were listed at the bottom of the text with the sales price noted at 10 cents per can.¹¹⁵ The foremost

¹¹⁴ Roland Marchand, *Advertising the American Dream: Making Way for Modernity, 1920-1940* (Berkeley: University of California Press, 1985), 56-57, 80-81, 228-229, 340.

¹¹⁵ Campbell Soup Company Advertisement, *Saturday Evening Post*, Vol. 187, No. 32 (February 6, 1915), p. 29.

theme in this advertisement was providing healthy nourishment for your children, but for the housewife the soup was convenient, economical, and came in a wide variety of flavors.

As noted earlier, the National Canners Association also advertised to create positive images of the canning industry. A 1921 advertisement in *Ladies' Home Journal* reassured customers about the safety of canned foods and secondarily noted the wide variety of products available in cans. The advertisement was in color, a much more expensive medium. The background was a farm field, and in the forefront was an image of a woman holding a cornucopia from which poured a wide variety of fruits and vegetables. Prominently displayed in the center of the full-page ad was the seal of the NCA's Sanitary Inspection Service. The text of the advertisement explained that the seal was awarded to those processors who had passed an inspection by the NCA, and the seal on a can of food "brings into the lives of millions of American women a guidance and assurance in the selection of canned foods." The seal indicated that "the canned foods on which it appears were made from selected, wholesome materials received, prepared and canned under sanitary conditions." The seal also meant that the consumer was "assured standards of preparation developed by a century of practical experience, aided by years of scientific research." At the bottom right hand corner of the advertisement was a selection of canned goods: fruits, meats, vegetables, and seafood products, that delivered the message of variety.¹¹⁶

¹¹⁶ National Canners Association Advertisement, *Ladies' Home Journal*, Vol. 38, No. 2 (January 405

Advertising was essential for canners and can manufacturing companies to increase demand for their products. The primary purpose was to generate additional sales by stressing how their products complemented modern American society, but secondarily to reassure consumers and educate those unfamiliar with how to use their products. Advertising began in the late nineteenth century in the form of booklets, then gravitated to sales pamphlets, but the predominant form was print advertisements in national periodicals directed at middle-class women. The themes varied but stressed quality, variety convenience, affordability, freshness, and nutrition. However, other themes in periodical advertisements reassured customers of the safety of canned foods, educated them in their use by providing recipe booklets, or reinforced social themes such as the housewives' role in preparing family meals, entertaining, or preparing for unexpected guests. A wide variety of actors in the canning industry advertised -- canners, can manufacturers, and trade associations. Unquestionably, the advertising campaign was effective. Consumption of canned foods continued to increase in later decades of the twentieth century from their limited place in the pantry of late nineteenth-century America.

Conclusion

Canned foods were already well established by 1900. They had widespread appeal for most Americans because of increasing affordability and the belief that canning was a superior food preservation technology compared with other alternatives.

1921), p. 138.

Urbanization, unquestionably, with more consumers removed from the point of food production, made for a large potential market. Despite this seemingly positive future for canned foods, there were consumer concerns regarding their safety. While the fears did not significantly retard the growth of the industry, it was a concern for canners and can manufacturers. The adoption of scientific methods for canning and the eventual formation of national trade organizations were not developments caused by the suspicion of canned goods by some Americans but are best interpreted as elements of professionalization and maturation of the industry. Nevertheless, science and trade organizations did help convince those still skeptical of canned foods to purchase them. The Pure Food and Drugs Act of 1906 was undoubtedly a factor in the formation of the National Canners Association, but a national organization had been contemplated by regional members for several years. One of the most significant objectives of the NCA was to challenge claims of poisoning where canned foods were identified as the culprit. The organization quickly transitioned to more pro-active measures, such as the establishment of a national network of research laboratories and the publication of educational materials for the industry and general public. Eventually, advertising that stressed how canned foods complemented American lifestyles of the early twentieth century and reassured consumers about the safety of the product proved to be an effective strategy for the canning and can manufacturing industries. Scientifically based processing, quality, freshness, affordability, variety, nutrition, entertaining guests, and preparing family meals struck a chord with Americans. By placing consumers at the

center of their industry, listening to and addressing their expectations, and managing and increasing demand, the canning and can manufacturing industries continued to grow and prosper in the early to mid-twentieth century.

Chapter 7 – Conclusion

Canning has no counterpart in nature. Canning is a method of controlling natural processes. Canning is a capital invention which has changed the eating habits of the western world.

Dr. Norman W. Desrosier, 1970¹

Dr. Desrosier was the director of research for the National Biscuit Company when he wrote these words in 1970 and they are a fitting epitaph for this project. Canning sought to preserve the bounty of nature and control the natural processes of deterioration through encapsulation and preservation in a vessel. After initial experiments by Nicholas Appert in glass containers, by the mid-nineteenth century the preferred protective barrier was the tin can. Canned foods were originally expensive and consumed by the wealthiest Americans, used as victuals for government sponsored exploration, or provided for military operations. However, through innovative technological developments and the application of increasing amounts of capital, among other elements, the cost of manufacturing a tin can decreased dramatically. Canning food with the tin container became a food preservation technology affordable for a growing number of Americans. By the twentieth century, consumers were presented with an almost unimaginable plethora of out-of-season foods in a convenient form of packaging. Affordability, variety, and convenience became the most important attributes of canned food, and in this sense, they did change the "eating habits of the western world."

¹ Norman W. Desrosier, Ph.D., *The Technology of Food Preservation*, 3rd ed. (Westport, Conn.: The AVI Publishing Company, 1970), 164-165.

The article from *Fortune* in 1941 cited in the introduction placed the tin can and its principal manufacturer – the American Can Company – alongside other giants of twentieth-century American industry: Ford Motor, General Electric, American Telephone and Telegraph, and R.C.A. The article stated that “the absence of any of the five, or of the industry it symbolizes, would change the pattern of life in the U.S. past recognition.”² The tin can was the technology which enabled the mass production of canned food, thereby forever changing how Americans ate and lived. The tin can was a deceptively simple four-piece, then three-piece device, by the early twentieth century; yet it had spawned a font of technological creativity before it had become a safe and inexpensive staple item in the American kitchen. Although tin cans are unpretentious items, the history of their technological development is a reminder for historians of technology that unglamorous technologies often have an important and enlightening history behind them.

The United States Army, and Navy to a lesser degree, popularized and familiarized the American public with the tin can. Canned food was still undemocratically distributed in the Civil War. During the Civil War, canned goods were not part of the regular ration of the Union Army, but soldiers still had contact with the novel technology. Officers, who had to purchase their own rations, were paid enough to purchase the expensive items in tin cans and would often consume them at the officer’s mess. However, the common enlisted soldier had access to canned food. Sutlers, a

² *Fortune*, January 1941, p. 53.

veritable general store on wagon wheels, carried canned goods. Borden's condensed milk was an expensive but extremely popular item as it added flavor to the bitter coffee that soldiers drank in large quantities. Packages from home often contained delicacies that added variety to a soldiers' diet, and canned food, especially jelly or fruit, were common items. Canned goods were often provided to soldiers recovering from wounds in a field hospital to speed their healing, as well as add more nutritious fare to their diet. Canned goods could also be purchased from the Commissary Department from excess monies in the "company fund" and used to procure normally unavailable items, such as canned food. After the war the Army provided canned goods to soldiers serving at distant posts that were quite removed from normal Army supply channels. Further, the military recognized the utility of canned rations and expanded their use. Discharged soldiers returning home also saw the benefits of the new food preservation technique. Canned goods added variety to the diet; it was a durable food storage technology; and it was a method to save food produced in one season for use in another. The major drawback of canned food was the price, but there was a cadre of actors ready to improve upon this invention.

Technological innovation was instrumental in lowering the price of canned goods and diffusing their use throughout America. The "Golden Age" of technological development occurred in the four decades following the Civil War. In the 1860s, a tin can cost twenty-five cents each, but by the end of first decade of the twentieth century the price was less than two cents per can. There were five phases of technological

development for the tin can. The craft or hand-made phase of development began in the 1810s and lasted until the 1850s. Primarily the creation of tinsmiths working with hand tools, cans could be produced at the rate of around 60 cans per ten-hour day. The second phase was proto-mechanization that began in the 1840s and lasted until the 1860s. In this phase, can-makers utilized simple punch presses, slitters for can bodies, and improved bench tools to expedite the soldering of side seams. The third phase of can-making, semi-automatic mechanization, began in the 1870s. Nearly every aspect of can manufacturing was transformed during this phase. Special attention was given to the operations limiting throughput, such as shearing tin plate, soldering side seams, and attaching tops and bottoms.

The fourth phase, integration, occurred in the 1880s and was different in emphasis than previous phases. During integration, innovators, such as Edwin Norton, began to link machines into a sequential process of manufacture. The result, in 1883, was the can-making assembly line. Also during this phase, the functions of canning and can-making began a slow separation, the result being a new industry, specialist can-making companies. Finally, product design, the final phase of technological development, began in the late 1880s and culminated with the successful deployment of the "sanitary can" in the first decade of the twentieth century. The sanitary can replaced the "hole-in-cap" can, a four piece can that had been the mainstay of the industry throughout the nineteenth century. The new style sanitary can was amenable to high-speed production, and fully automatic can-making equipment capable of

manufacturing 72,000 cans in a ten-hour day became the norm. The major innovations of the nineteenth and early twentieth centuries were accomplished by independent inventors, such as Allen Taylor, William Numsen, Dr. William Mann, Edwin Norton, and George Cobb.

The process of technological diffusion, however, was anything but uniform in can-making. Selected case studies demonstrated the varied and differential pace of technological diffusion. Businesses adopted specific technology according to their individual commercial objectives and conditions. As new technology became available, can manufacturers adopted it if the capital expenditure significantly reduced their expenses or improved product quality. The Wayne County Preserving Company of Newark, New York was a regional canner that manufactured their own tin cans, but eventually transitioned to purchasing cans from specialist can-making companies. The H. S. Mill Canning Company of Springtown, Pennsylvania was a small, local canner that purchased all their cans from specialist firms. The Cobb Preserving Company of Fairport, New York manufactured their own cans and was also the site for the development, deployment, and commercialization of the sanitary can. The Norton Brothers of Maywood, Illinois, were one of the first specialist can manufacturing companies, so they readily adopted the latest technology, much of it developed themselves. Finally, large food marketers, such as H. J. Heinz, Borden's, and the Franco-American Company had enough volume to justify the purchase of the most modern can-making technology to self-manufacture. However, other firms within this group, such as Campbell Soup,

sourced their cans from specialist firms so they could concentrate on marketing their products. Taken as a group, these firms were fairly representative of the differential pace of technological diffusion within the can-making industry and present a landscape of the industry.

The can-making industry consolidated in the early twentieth century with the emergence of a duopoly governed by the American Can Company and the Continental Can Company. By the early twentieth century, the can was such an important industrial development that the leading manufacturer of cans, American Can Company, became a component of the Dow Jones Industrial Average, where it stayed for over seventy-five years.³ The process of consolidation did not fit Alfred Chandler's model for the rise of the corporate form of organization in American business in the late nineteenth century. The industry behemoths came to dominance neither from administrative efficiency nor technological innovation. They organized the industry based upon a clumsy financial maneuver to monopolize the market and had the good fortune of having the largest tin can consumer in the world as a principle customer.

An overriding question, however, was whether the consolidation of the industry would thwart the increasing democratization of the tin can. In the landmark 1913 case, *United States v. American Can Company et. al.*, the government interjected itself into business practices which were potentially injurious to the public welfare. It did not

³ <http://stat1.moneycontrol.com/Dow> Jones Industrial Average Historical Components.pdf (accessed May 23, 2013).

dismantle American Can because competition ensured that American Can could no longer price cans as they pleased. Consolidation did stabilize prices and changed patterns of technological development. Incremental innovation, the product of research and development by American Can and Continental Can, became the norm, rather than breakthrough innovations such as the sanitary can.⁴

Can-makers and canners did not solely depend upon supply-side initiatives, such as technology and consolidation, to decrease and stabilize prices. They also had to manage consumer expectations and increase demand for their products. Canned food had become firmly established as a fixture in the kitchen and American food landscape between 1900 and 1920. The growing number of Americans living in cities had separated producers from consumers of food products. Additionally, working-class homes of the era were small with little storage space, so inexpensive canned foods were ideal for these material conditions. Such dynamics presented canners and can manufacturers with the potential for increased sales, but there were still lingering suspicions amongst some of the public surrounding canned foods.

The misgivings often had cultural roots or were the product of salacious stories in the media. The canning and can manufacturing industries placed the customer in the

⁴ Ironically, while neither American Can nor Continental Can remain in operation today, remnants of their organizations, along with those of National, Pacific, and Heekin, still exist. However, the plants are operated by the Ball Corporation or the Silgan Corporation, two of the three major contemporary manufacturers of food cans. The sole survivor of the six major can companies in the 1930s is Crown Cork & Seal, a firm whose primary business in the 1930s was making bottle caps. In addition to bottle caps, today they manufacture beverage, food, and aerosol containers. The comments on Ball Corporation, the Silgan Corporation, and Crown Cork & Seal are based upon the author's prior experience and knowledge of the metal packaging industry.

center of their business universe in the early twentieth century and attempted to counter negative images of canned foods, especially by emphasizing that canning was scientific. The application of scientific methods in canning, based upon Pasteur's bacteriological discoveries of the 1860s, were first employed by scientists at the University of Wisconsin and Massachusetts Institute of Technology in the 1890s. A foundation in science, as the bedrock of future growth, gradually grew to govern the industry by the 1920s, with standard processing times, pressures, and temperatures available to canners through numerous sources.

In 1907, as a reaction to the Pure Food and Drugs Act in 1906, a national trade organization was created from a milieu of regional associations. The National Canners Association (NCA) gave canners, can manufacturers, and any entity associated with the canning industry a voice in legislative affairs. The activities of the NCA revolved around public relations to improve the image of the tin can, to disseminate data to advance the industry, and to educate the public of the utility of the product. The application of science and formation of a national trade association were not just reactions to lingering suspicions of canned food. They are best interpreted as elements of institutional maturation and professionalization. While not prerequisites for growth of the canning industry, science and the NCA did increase sales through educating the consumer and decreasing skepticism.

The ultimate pro-active action by canners and can manufacturers in the early twentieth century was advertising, primarily in periodicals directed at middle-class

women. The movement of canned goods into the kitchen was part of the larger pattern of social and economic change occurring in the first decades of twentieth-century America. For many Americans the tin can represented modernity, just as did the automobile, telephone, electric appliances, and radio; and this modern style of living was promoted by advertising to generate mass appeal. Themes of convenience, variety, affordability, nutrition, modern housekeeping, entertaining, and the scientific foundation of the industry had great resonance with many consumers. It is likely that this advertising did little to assuage misgivings about the tin can emanating from ethnic or religious food traditions. Nevertheless, while some Americans did not accept the tin can, the overall market for canned food continued to expand in the twentieth century. The combination of urbanization, application of science, the emergence of a national trade organization, and advertising presented canners and can manufacturers with bright prospects for continued growth by the late 1920s.

Epilogue

After the Great Depression, and for the balance of the 1930s and 1940s, the canning and can manufacturing industries experienced a period of considerable expansion. In the 1930s, steel manufacturers developed two significant innovations which facilitated even higher rates of tin can production. Rolled steel or coils were used in the manufacture of cans rather than individual sheets, and tin plate was

manufactured using a continuous electrolytic tin plating process, instead of dipping sheets in baths of molten tin. During World War II, the tin can was a major source of food for soldiers, sailors, Marines, and airmen. The iconic image of a soldier hungrily munching the contents of canned rations, regardless of the theatre in which they served, became a metaphor for the productive capabilities of democratic America. In the 1950s, canned foods experienced increasing popularity and became a symbol of American prosperity. On the television show *Father Knows Best*, the image of Margaret Anderson, adorned in a dress and high-heels, as she busily, yet calmly, prepared dinner using canned food for Jim and the rest of the Anderson family became ingrained in American popular culture. The featured role of the tin can demonstrated how ubiquitous canned foods had become in American life.

The next major technological innovations in can manufacturing occurred in the 1970s and 1980s with the development of welded side seams to replace the soldered side seam, easy-open tops for cans, and a two-piece container for small diameter food cans. The welded side seam improved the quality and reliability of tin cans, as well as lowered the costs of manufacture, through eliminating the application of solder, which had been used since the first tin cans were manufactured in the 1840s. The easy-open tops added convenience for the consumer and eliminated the need to search for a can opener. The two-piece can eliminated the side seam and bottom double seam, thereby lowering the cost of manufacture and reducing potential areas of leakage. None of these major innovations significantly expanded the market for tin cans. These

innovations only maintained market share being lost to other forms of packaging.⁵

Similar to the challenge presented by negative perceptions of tin cans in the early twentieth century, by the 1970s the tin can was under attack from other innovative forms of food packaging.

After World War II, a number of new and innovative food processing technologies presented the canning and can manufacturing industries with momentous challenges, but gave the consumer greater choices. Convenience, once an attribute of only canned foods, became the battleground. Frozen vegetables and fruits, Swanson's TV dinners, freeze-dried foods, ready-to-eat meals, bags of fruits and vegetables, tuna and chicken in re-sealable pouches, and microwavable dinners became as convenient, if not more so, than canned foods. Improved transportation systems and a nationwide interstate highway network made delivery of fresh fruits, vegetables, fish, meat, and poultry by refrigerated truck another food option for consumers. Fresh foods became readily available at farmer's markets, grocery stores, and high-end, all-inclusive shopping experiences, such as Wegman's or Whole Foods. The rise of fast-food restaurants, such as McDonalds and Burger King, was yet another option for the busy head of household to feed his or her family. The consumer, once the center of the canners' and can-makers' universe, now had many more options. In 1970, the size of the American market for canned food was 57 billion cans consumed annually.⁶ The

⁵ The welded side seam and two-piece can also improved the safety of the product by eliminating the use of lead-based solder.

⁶ Sacharow and Griffin, *Food Packaging: A Guide for the Supplier, Processor, and Distributor*, 24.

market for canned food peaked in the late 1970s and early 1980s, then it began a slow and steady decline. Over forty years later in 2012, Americans consumed 100 million tin cans a day for a total market size of between 35 and 40 billion food cans annually.⁷ The decline in the market for canned foods was a function of consumer choice, the availability of other food preservation technologies, and the increasing availability of fresh foods. Little wonder that in the late 1980s, the two largest food can manufacturing companies in the United States, American Can and Continental Can, were purchased by venture capitalists, dismembered, and their parts sold to the highest bidder.⁸ Only faint footprints of either company can be found today.

The shelf space dedicated to canned foods in a typical contemporary grocery store is dwarfed by the fresh produce area, the fish and meat counters, and the delicatessen station. Canned foods are neither the preeminent choice of shoppers, nor are the customers exclusively women as they were in 1920s advertisements. Canned foods are but one of many choices available to consumers. The contemporary grocery store, plethora of choice, and shopping habits of Americans should not obviate the fact, however, that canned foods were once viewed as incredibly innovative, enjoyed enormous popularity, and dominated the shelves of supermarkets and small corner grocery stores. Food in a tin can began as an exclusive choice for only the wealthiest

⁷ <http://www.cancentral.com/food-cans/facts> (accessed February 22, 2015). This is the website for the Can Manufacturers Institute (CMI) and it states "Americans use more than 100 million steel cans every day." This number extrapolates to 36.5 billion cans annually, or a range of 35 to 40 billion. The size of the market listed on the website correlates with the author's prior industry experience.

⁸ The comments on the sale of the American Can Company and Continental Can Company in the 1980s are based upon the author's first-hand experience working with a can manufacturing company composed from elements of the former industry leaders.

Americans, but over time it became a ubiquitous product. The change was because of a multitude of factors: the military in the Civil War had popularized and diffused the idea of canned foods among Americans, technological innovation had decreased the cost of manufacturing tins cans, consolidation of the industry further had decreased container costs, and demand management and meeting customer expectations had expanded the market for tin cans. The tin can represented military necessity, technological ingenuity, the development of American business enterprise, the rise of scientific production methods, and changing social mores. On your next sojourn to a grocery store, reach for a tin can and appreciate the historical significance of this seemingly innocuous invention.

BIBLIOGRAPHY

Primary Sources – Manuscripts

- American Can Company. "American Can Company Trade Literature, 1927." Lake Mohonk Mountain House Collection, Hagley Museum and Library, Manuscripts and Archives Section - Soda House, Greenville, Delaware, Accession Number 2280, Box 14, Folder 3.
- Civil War Subsistence Stores Reports, "Civil War Documents," 3 Unnumbered Boxes, Pieklik Learning and Research Center, United States Army Quartermaster Museum, Fort Lee, Virginia.
- Dichter, Ernest, Ph.D. The Ernest Dichter Papers, Hagley Museum and Library, Manuscripts and Archives Section - Soda House, Greenville, Delaware, Accession Number 2407, Box 10.
- Durham Evangelical Lutheran Church Cemetery Records. Durham Township, Bucks County, Pennsylvania, transcribed by Nancy Seiner and Marjory Payne, 1992.
- Edgett-Burnham Company Records, 1854-1930. Division of Rare and Manuscript Collections, Carl A. Kroch Library, Cornell University, Ithaca, New York, Archive Number 2522.
- Food Inspection Reports, The Davis Brigade, 2nd Brigade, 52nd Pennsylvania Volunteer Regiment, The Pennebaker Collection. Spruance Library, Bucks County Historical Society, Doylestown, Pennsylvania, MSC 255, Box 19, Folder 2.
- Mill, H. S. "H. S. Mill Canning Company Letterbook, 1905 - 1908." Hagley Museum and Library, Manuscripts and Archives Section - Soda House, Greenville, Delaware, Accession Number 2497.
- New York State Food Processing Industry Oral History Project. Division of Rare and Manuscript Collections, Carl A. Kroch Library, Cornell University, Ithaca, New York, Archive Number 2378.
- Postcard Collection. Spruance Library, Bucks County Historical Society, Doylestown, Pennsylvania, SC 36.
- Quakertown and Delaware River Railroad Collection. Spruance Library, Bucks County Historical Society, Doylestown, Pennsylvania, MSC 171.
- Raylman, Henry R. "Diary of Henry R. Raylman October 16, 1862 – August 6, 1863." Spruance Library, Bucks County Historical Society, Doylestown, Pennsylvania, Miscellaneous Manuscripts Collections, MSC 788, Folder 18.

Various Authors. "Business Records of the American Can Company." Maywood Public Library, Maywood, Illinois, Box G-1.

Primary Sources – Government Publications

Commonwealth of Pennsylvania. *The Canning Industry in Pennsylvania: Origin, Growth and Important Characteristics*. Prepared by the Research and Statistics Division of the Bureau of Employment and Unemployment Compensation. Harrisburg, Pa.: Commonwealth of Pennsylvania, 1949.

Dodge Commission Report. *Food Furnished by Subsistence Department to Troops in the Field: Record of a Court of Inquiry*. Part III. Washington, D.C.: Government Printing Office, 1900.

U. S. Department of Commerce, Bureau of the Census. *Abstract of the Census of Manufactures 1914*. Washington, D. C.: GPO, 1917.

U. S. Department of Commerce, Bureau of the Census. *Census of Manufactures 1914*. Volume II, Reports for Selected Industries and Detail Statistics for Industries by States. Washington, D.C.: GPO, 1919.

U. S. Department of Commerce, Bureau of the Census. *Census of Manufactures 1923*. Washington, D. C.: GPO, 1926.

U. S. Department of Commerce, Bureau of the Census. *Census of Manufactures 1927*. Washington, D. C.: GPO, 1930.

U. S. Department of Commerce, Bureau of the Census. *Census of Manufactures 1958*. Volume II, Industry Statistics, Part 2, Major Groups 29 to 39, Washington, D. C.: GPO, 1961.

U. S. Department of Commerce, Bureau of the Census. *Historical Statistics of the United States: Colonial Times to 1970*. Part 1. Washington, D.C.: GPO, 1975.

U. S. Department of Commerce, Bureau of the Census. *Historical Statistics of the United States: Colonial Times to 1970*. Part 2. Washington, D.C.: GPO, 1975.

U. S. Department of the Interior. *The Statistics of the Wealth and Industry of the United States*. Ninth Census, Volume III, Washington, D.C.: GPO, 1872.

U. S. Department of the Interior, Census Office. *1870 United States Federal Population Census*, National Archives: College Park, MD, Film No. 552813.

U. S. Department of the Interior, Census Office. *Report on the Manufactures of the United States at the Tenth Census, June 1, 1880*. Volume II. Washington, D. C.: GPO, 1883.

U. S. Department of the Interior, Census Office. *1880 United States Federal Population Census*, National Archives: College Park, MD, Film No. T9-1107.

- U. S. Department of the Interior, Census Office. *Twelfth Census of the United States Taken in the Year 1900*. Volume IX, Manufactures, Part III, Special Reports on Selected Industries, Washington, D.C.: GPO, 1902.
- U. S. Navy Department, Bureau of Supplies and Accounts. *Specifications for Tinned Corned Beef*. A. S. Kenny, Paymaster General, U. S. Navy, Washington, D. C., July 1, 1899. CIS Executive Branch Documents, 1789-1909, oclc# 244126796.
- U. S. Patent and Trademark Office, Washington, D. C., <http://www.uspto.gov>.
- U. S. War Department. *Regulations for the Quartermasters Department, of the United States Army*. Washington, D.C.: A. B. Claxton and Company Printers, 1838.
- U. S. War Department. *Revised United States Army Regulations of 1861 with an Appendix Containing the Changes and Laws Affecting Army Regulations and Articles of War to June 25, 1863*. Washington, D. C.: Government Printing Office, 1863.
- U. S. War Department, Subsistence Department. *Handbook of Subsistence Stores*. Compiled Under the Direction of the Commissary General, from Monographs Written by Officers of the Subsistence Department [with notes on canned goods and insects]. Washington, D.C.: Government Printing Office, 1896.
- U. S. War Department, Subsistence Department. *Manual for Army Cooks Prepared Under the Direction of the Commissary General of Subsistence*. Washington, D.C.: Government Printing Office, 1896.
- U. S. War Department, Subsistence Department. *Handbook of Subsistence Stores*. Compiled Under the Direction of the Commissary General, from Monographs Written by Officers of the Subsistence Department [on preparation methods and specifications for food and other stores; with notes on canned goods and insects, and data on acceptable storage temperatures for perishable foods]. Washington, D.C.: Government Printing Office, 1900.
- Wilson, Thomas, Captain. *Notes on Canned Goods*. Prepared Under the Direction of the Commissary General of Subsistence, U. S. Army. Washington, D.C.: United States War Department, Subsistence Department, 1870.

Primary Sources – Industry Published Pamphlets, Booklets, Addresses, and Trade Catalogues

- A. K. Robins and Company. *Catalogue of Canning Machines and Cannery Supplies*. Baltimore: A. K. Robins and Company, 1920.
- American Can Company. *The Canned Food Reference Manual*. New York: American Can Company, 1939.
- _____. *Canned Food Manual*. Prepared for the United States Army with the Help and Advice of the Subsistence Branch, Office of the Quartermaster General. New York: American Can Company, 1942.
- _____. *American Can Company in Wartime*. New York: American Can Company, 1943.
- _____. *The Canned Food Reference Manual*, 2d ed. New York: American Can Company, 1943.
- Appert, Nicolas. *The Book for All Households; Or, The Art of Preserving Animal and Vegetable Substances for Many Years*. Paris: Patris and Company, 1810. Translated by Katherine Golden Bitting. Chicago: Glass Container Association of America, 1920. Reprint, Charleston, S. C.: Nabu Press, 2010.
- Arthur, Burnham and Company. *Arthur's Patent Air-Tight, Self-Sealing Cans and Jars for Preserving Fruits and Vegetables*. Philadelphia: Arthur, Burnham and Company, 1856.
- Ayars Machine Company. *Catalogue of Presses, Dies, Can-Making Tools, Can-Filling Machines, Platform Conveyors, and Supplies*. Salem, N.J.: Ayars Machine Company, 1900.
- Baker, Herbert A. *Status of the Tin Can in the Canned Foods Industry*. An Address Given in New York City to the New York Wholesale Grocers' Association on February 13, 1923. New York: American Can Company, 1923.
- Biardot, A. *Franco-American Soups: How They Are Made*. Jersey City Heights, N.J.: The Franco-American Food Company, 1897.
- Bigelow, W. D. *Swells and Springers*. Published by the Research Laboratories of the National Cannery Association. Baltimore: The Lord Baltimore Press, Bulletin Number 2 (August 1914).
- Can Manufacturers Institute. *The History of the Metal Can and Its Service to Man*. Washington, D.C.: Can Manufacturers Institute, 1960.
- Cox, Brother and Company. *Catalogue No. 4, Cannery Machinery Manufactured and for Sale by Cox, Bro. & Co.* Elmer, N.J.: Times Print, 1900.

- Curtis Publishing Company and Richard J. Walsh. *Selling Forces*. Philadelphia: The Curtis Publishing Company, 1913.
- Eames, Alfred W., Jr. and Richard G. Landis. "The Business of Feeding People: The Story of the Del Monte Corporation." An Address Given in San Francisco, California to the Newcomen Society in North America on November 7, 1973. Princeton: Princeton University Press, 1974.
- E. F. Kirwan Manufacturing Company. *Catalogue of Cans, Machinery, and General Canning House Supplies*. Baltimore: The Friedenwald Company, 1890.
- E. W. Bliss Company. *Automatic Can-Making Machinery, Section 18*. Brooklyn, N.Y.: E. W. Bliss Company, 1914.
- Ferracute Machine Company. *Catalogue "D": Illustrated Catalogue and Price List of Presses, Dies, Can-Makers' Machinery and other Sheet Metal Tools*. Bridgeton, N.J.: Ferracute Machine Company, 1885.
- _____. *Catalogue "E": Revised Price List for Presses, Dies, etc.* Bridgeton, N.J.: Ferracute Machine Company, 1891.
- Gamble, Theodore R. "75 Years of PET Milk Company (1885-1960): The Company That Founded an Industry." An Address Given in St. Louis, Missouri to the Newcomen Society in North America on October 13, 1960. Princeton: Princeton University Press, 1960.
- Hall and Carpenter. *Hall & Carpenter's Catalogue of Tinsmiths' Tools and Machines*. Philadelphia: Charles C. Douglass, 1878 and 1886.
- Judge, Arthur I., ed. *A History of the Canning Industry By Its Most Prominent Men*. Baltimore: National Cannery Association, 1914.
- MacNaughtan, D. J., Director. *Tin Plate and Tin Cans in the United States*. Published by The International Tin Research and Development Council. London, England: Lund, Humphries and Company, Number 4 (October 1936).
- Max Ams Machine Company. *Catalogue #17 Max Ams Machine Company - Panama Exposition, San Francisco, California, 1915*. Mount Vernon, N. Y.: The Max Ams Machine Company, 1915.
- Merchant and Company. *Price List of Merchant and Company*. Philadelphia: A. C. Bryson, 1880.
- National Cannery Association. *The Story of the Canning Industry*. Washington, D. C.: The National Cannery Association, 1948.
- _____. *The Canning Industry: Its History, Importance, Organization, Methods, and the Public Service Value of Its Products*. Washington, D. C.: The National Cannery Association, 1952.

- _____. *The Canning Industry: Its History, Importance, Organization, Methods, and the Public Service Value of Its Products*. Washington, D. C.: The National Cannery Association, 1971.
- Sears, Walter J. *The Farmer and the Canner: An Address Delivered Before the Western Cannery Association*. Chicago, Ill. April 15, 1920.
- Sprague Canning Machinery Company. *Sprague General catalogue of Canning Machinery and Supplies*. Chicago: Sprague Canning Machinery Company, 1913.
- Stecker, C. H., ed. *The Seal of Safety Year Book*. Volume 2. Mount Vernon, N.Y.: The Max Ams Machine Company, 1915.
- Stolk, William C. *American Can Company: A Revolution in Containers*. An Address Given in New York City to the Newcomen Society in North America on April 21, 1960. Princeton: Princeton University Press, 1960.
- Stuart, Richard. "The National Can Story: In An Historic Industry, An Historic Company Organized for the Future." An Address Given in Chicago, Illinois to the Newcomen Society in North America on April 29, 1971. Princeton: Princeton University Press, 1971.
- White, Henry A. "James D. Dole: Industrial Pioneer of the Pacific." An Address Given in Honolulu, Hawaii to the Newcomen Society in North America on June 27, 1957. Princeton: Princeton University Press, 1957.
- William Vogel and Brothers. *Catalogue of Tin Ware Manufactured by William Vogel & Brothers*. Brooklyn, N. Y.: William Vogel & Brothers, 1880.

Primary Sources – Contemporary Magazines

- "Hollingsworth's Can-Soldering Apparatus." *Scientific American*, May 11, 1867: 300.
- "Tin Cans and Foods." *Scientific American*, Volume XLVIII, No. 22, June 2, 1883: 341.
- "Norton's Automatic Can Making Machinery." *American Machinist*, Volume 6, Number 28 (July 14, 1883): 1-2.
- "Improved Tin Can Machinery." *Scientific American Supplement*, Volume XVI, No. 398 (August 18, 1883): 6346-6347.
- "The American Can Company." *Fortune Magazine*, November 1930, 39-42, 112, 114.
- "Profits in Cans." *Fortune Magazine*, April 1934, 76-85, 134, 136, 138.
- "Beer Into Cans." *Fortune Magazine*, January 1936, 75-80, 82, 84, 156-157.
- "American Can Company." *Fortune Magazine*, January 1941, 52-59, 98-100, 102, 104.

Woolley, Edward Mott. "Tin Canners: The Story of the Greatest Utility Industry of the Age and the Men Who Built It." *McClure's Magazine*, Volume 42, Number 5 (March, 1914): 70-78.

Primary Sources - Court Cases / Decisions

United States v. American Can Company, et. al., Original Petition, District Court, District of Maryland, November 29, 1913.

United States v. American Can Company, et. al., 230 Federal, District Court, District of Maryland, February 23, 1916.

United States v. American Can Company, et. al., 234 Federal, District Court, District of Maryland, July 7, 1916.

Primary Sources – Contemporary Newspapers

Chicago Times, 6 November 1938.

Chicago Tribune, 31 May 2005.

The New York Times, 26 July 1896, 23 December 1907, 30 November 1913, 1 September 1923, 5 October 1930.

Riegelsville Standard, 16 April, 1886.

Primary Sources -- Contemporary Periodical Advertisements

Armour Beef Extract Advertisement. *Ladies' Home Journal*, Volume 22, Number 11 (January 1905): 31.

Burnham and Morrill Company Baked Bean Advertisement. *Ladies' Home Journal*, Volume 24, Number 4 (March 1907): 31.

Campbell's Soup Advertisement. *Saturday Evening Post*, Volume 187, Number 32 (February 6, 1915): 29.

National Canners Association Seal of Approval Advertisement. *Ladies Home Journal*, Volume 38, Number 2 (January 1921): 138.

National Canned Foods Week Advertisement. *Saturday Evening Post*, Volume 194, Number 35 (February 25, 1922): 25.

Secondary Sources – Published Books

- Barbier, Jean-Paul. *Nicolas Appert: Inventuer et Humaniste*. Chicago: University of Chicago Press, 1994.
- Benson, Susan Porter. *Household Accounts: Working-Class Family Economics in the Interwar United States*. Ithaca, N.Y.: Cornell University Press, 2007.
- Billings, John D. *Hardtack and Coffee or The Unwritten Story of Army Life*. Lincoln: University of Nebraska Press, 1993 (1887).
- Bitting, A. W. and K. G. Bitting. *Canning and How to Use Canned Foods*. Washington, D. C.: National Capitol Press, 1916.
- Bitting, A. W. *Appertizing or The Art of Canning; Its History and Development*. San Francisco: The Trade Pressroom, 1937.
- Bjorkland, Richard C. *R. S. Solinsky: Dean of the Can Industry*. Chicago: National Can Company, 1969.
- Blinn, Leroy J. *A Practical Companion for the Tin, Sheet-Iron, and Copper Smith*. Detroit: Barns, French, and Way Printers, 1859.
- Boorstin, Daniel J. *The Americans: The Democratic Experience*. New York: Random House, 1973.
- Brewer, Priscilla J. *From Fireplace to Cookstove: Technology and the Domestic Ideal in America*. Syracuse, N.Y.: Syracuse University Press, 2000.
- Brodie, Bernard and Fawn. *From Crossbow to H-Bomb: The Evolution of the Weapons and tactics of Warfare*. Bloomington: Indiana University Press, 1962.
- Brody, David. *Steelworkers in America: The Nonunion Era*. Urbana: The University of Illinois Press, 1998 (1960).
- Capatti, Alberto. "The Taste for Canned and Preserved Food." In *Food: A Culinary History from Antiquity to the Present*, eds. Jean-Louis Flandrin and Massimo Montanari, 492-499. New York: Columbia University Press, 1999.
- Chandler, Alfred D. *The Visible Hand: The Managerial Revolution in American Business*. Cambridge: Harvard University Press, 1977.
- Clark, Hyla M. *The Tin Can Book: The Can as Collectible Art, Advertising Art, and High Art*. New York: New American Library, 1977.
- Coffin, Margaret. *The History and Folklore of American Country Tinware 1700-1900*. Camden, N.J.: Thomas Nelson and Sons, 1968.
- Cohen, Lizabeth. *A Consumer's Republic: The Politics of Mass Consumption in Postwar America*. New York: Random House, 2003.

- Collins, James H. *The Story of Canned Foods*. New York: E. P. Dutton and Company, 1924.
- Cowan, Ruth Schwartz. "The Consumption Junction: A Proposal for Research Strategies in the Sociology of Technology." In *The Social Construction of Technological Systems*, eds. Weibe E. Bijker, Thomas P. Hughes, and Trevor J. Pinch, 261-280. Cambridge: MIT Press, 1987.
- Cummings, Richard Osborn. *The American and his Diet*. Chicago: The University of Chicago Press, 1940. Reprint, New York: Arno Press, 1970.
- Demer, John H. *Jedediah North's Tanners Tool Business*. South Burlington, Vt.: The Early American Industries Association, 1973.
- Derosier, Norman W. *The Technology of Food Preservation*. 3rd Edition. Westport, Conn.: The AVI Publishing Company, 1970.
- Devoe, Shirley Spaulding. *The Tinsmiths of Connecticut*. Middletown, Conn.: Wesleyan University Press, 1968.
- Doerrfeld, Dean A. *The Canning Industry in Delaware; 1860-1940 +/-: A Historic Context*. Newark, Del.: University of Delaware, 1993.
- Fowler, Earl P. *Can Crafts*. Radnor, Pa.: The Chilton Book Company, 1977.
- Flandrin, Jean-Louis. "Introduction: From Industrial Revolution to Industrial Food." In *Food: A Culinary History from Antiquity to the Present*, ed. Jean-Louis Flandrin and Massimo Montanari, 435-441. New York: Columbia University Press, 1999.
- Francis, Clarence. *A History of Food and Its Preservation: A Contribution to Civilization*. Princeton: The Princeton University Press, 1937.
- Franz, Joe B. *Gail Borden: Dairyman to a Nation*. Norman: University of Oklahoma Press, 1951.
- Freidel, Frank. *The Splendid Little War: The Dramatic Story of the Spanish – American War*. Short Hills, N.J.: Burford Books, 2002.
- Fuller, J. F. C. *Armament and History: The Influence of Armament on History from Classical Warfare to the End of the Second World War*. London: Charles Scribner's Sons, 1945. Reprint, New York: DeCapo Press, 1998.
- Giedion, Siegfried. *Mechanization Takes Command: A Contribution to Anonymous History*. New York: Oxford University Press, 1948.
- Gould, Mary Earle. *Antique Tin and Tole Ware: Its History and Romance*. Rutland, Vt.: Charles E. Tuttle Company, 1958.
- Hampe, Edward C. Jr. and Merle Wittenberg. *The Lifeline of America: Development of the Food Industry*. New York: McGraw – Hill Book Company, 1964.

- Hasluck, Paul N., ed. *Tinplate Work: With Numerous Engravings and Diagrams*. Philadelphia: David McKay Publishers, 1908.
- Hedges, Ernest S. *Tin in Social and Economic History*. New York: St. Martin's Press, 1964.
- Heite, Edward F. *Archaeological Data Recovery on the Collins, Geddes Cannery Site*. Dover, Del.: Delaware Division of Highways, 1990.
- Hindle, Brooke and Steven Lubar. *Engines of Change: The American Industrial Revolution, 1790-1860*. Washington, D. C.: The Smithsonian Institution Press, 1986.
- Hounshell, David A. *From the American System to Mass Production, 1800-1932: The Development of Manufacturing Technology in the United States*. Baltimore: Johns Hopkins University Press, 1984.
- Hucles, Michael E. *From Haversack to Checkout Counter: A Brief History of the Army Commissary System*. Fort Lee, Va.: U. S. Army Troop Support Agency, 1991.
- Hughes, Thomas P. *American Genesis: A Century of Invention and Technological Enthusiasm, 1870-1970*. Chicago: The University of Chicago Press, 2004.
- Kauffman, Henry J. *Early American Copper, Tin and Brass*. New York: Medill McBride and Company, 1950.
- Kee, Ed. *Saving Our Harvest: The Story of the Mid-Atlantic Regions' Canning and Freezing Industry*. Baltimore: CTI Publications, 2006.
- Kuhlmann, Charles B. "The Processing of Agricultural Products in the Pre-Railway Age." In *The Growth of the American Economy*, ed. Harold F. Williamson, 189-209. New York: Prentice Hall, 1944.
- Lasansky, Jeannette. *To Cut, Piece, and Solder: The Work of the Rural Pennsylvania Tinsmith; 1778-1908*. University Park, Pa.: The Pennsylvania State University Press, 1982.
- Lawrence, T. E. *Seven Pillars of Wisdom: A Triumph*. Dorset Press Edition (1988). New York: Doubleday, Duran, and Company, 1935.
- Lifshey, Earl. *The Housewares Story: A History of the American Housewares Industry*. Chicago: The National Housewares Manufacturers Association, 1973.
- Lord, Francis A. *Civil War Sutlers and Their Wares*. New York: Thomas Yoseloff, 1969.
- Lynd, Robert S. and Helen Merrell Lynd. *Middletown: A Study in Modern American Culture*. New York: Harcourt Brace and Company, 1929.
- Marchand, Roland. *Advertising the American Dream: Making Way for Modernity, 1920-1940*. Berkeley, Calif.: University of California Press, 1985.

- May, Earl Chapin. *The Canning Clan: A Pageant of Pioneering Americans*. New York: The MacMillan Company, 1937.
- McCafferty, E. D. *Henry J. Heinz: A Biography*. New York: Bartlett Orr Press, 1923.
- McKie, James W. *Tin Cans and Tin Plate: A Study of Competition in Two Related Markets*. Cambridge: Harvard University Press, 1959.
- Mokyr, Joel. *The Lever of Riches: Technological Creativity and Economic Progress*. New York: Oxford University Press, 1990.
- Mumford, Lewis. *Technics and Civilization*. With a New Forward by Langdon Winner. Chicago: The University of Chicago Press, 2010 (1934).
- Okun, Mitchell. *Fair Play in the Marketplace*. Dekalb, Ill.: Northern Illinois University Press, 1986.
- Pound, Arthur. *Industrial America: Its Way of Work and Thought*. Boston: Little, Brown, and Company, 1936.
- Powers, Beatrice Farnsworth and Olive Floyd. *Early American Decorated Tinware with Designs and Practical Directions*. New York: Hastings House Publishers, 1957.
- Rhodes, Robert Hunt, ed. *All for the Union: The Civil War Diary and Letters of Elisha Hunt Rhodes*. New York: Vintage Books, 1992.
- Risch, Erna. *Quartermaster Support of the Army: A History of the Corps, 1775 - 1939*. Washington, D.C.: Center of Military History, United States Army, 1989.
- Ruiz, Vicki. *Cannery Women, Cannery Lives: Mexican Women, Unionization, and the California Food Processing Industry, 1930-1950*. Albuquerque, N.Mex.: The University of New Mexico Press, 1987.
- Sacharow, Stanley and Roger C. Griffin. *Food Packaging: A Guide for the Supplier, Processor, and Distributor*. Westport, Conn.: The AVI Publishing Company, 1970.
- Scranton, Philip. *Endless Novelty: Specialty Production and American Industrialization, 1865-1925*. Princeton: Princeton University Press, 1997.
- Shephard, Sue. *Pickled, Potted, and Canned: How the Art and Science of Food Preserving Changed the World*. New York: Simon and Schuster, 2000.
- Singer, Charles, E. J. Holmyard, A. R. Hall, and Trevor I. Williams, eds. *A History of Technology*. Volume 5, *The Late Nineteenth Century, c. 1850 to c. 1900*. New York: Oxford University Press, 1958.
- Skemp, Robert. *The Evolution of a Tin Can, with a Brief Introduction on the Manufacture of Iron and Steel*. Pittsburgh, Pa.: American Sheet and Tinplate Company, 1928.
- Smith, Merritt Roe. *Harpers Ferry Armory and the New Technology: The Challenge of Change*. Ithaca: Cornell University Press, 1977.

- Strasser, Susan. *Never Done: A History of American Housework*. New York: Henry Holt and Company, 1982.
- Swank, Edith Elliott. *The Story of Food Preservation*. Pittsburgh, Pa.: H. J. Heinz Company, 1943.
- Thorne, Stuart. *The History of Food Preservation*. Totowa, N.J.: Barnes and Noble Books, 1986.
- Turner, Katherine Leonard. "Tools and Spaces: Food and Cooking in Working-Class Neighborhoods, 1880-1930." In *Food Chains: From Farmyard to Shopping Cart*, eds. Warren Belasco and Roger Horowitz, 217-232. Philadelphia: University of Pennsylvania Press, 2009.
- Watkins, Sam R. *"Co. Aytch:" A Confederate Memoir of the Civil War*. New York: Simon & Schuster, 2003 (1882).
- Wiley, Bell Irvin. *The Life of Johnny Reb: The Common Soldier of the Confederacy*. Baton Rouge: Louisiana State University Press, 2008 (1943).
- _____. *The Life of Billy Yank: The Common Soldier of the Union*. Baton Rouge: Louisiana State University, 2008 (1952).
- Wilkeson, Frank. *Turned Inside Out: Recollections of a Private Soldier in the Army of the Potomac*. Introduction by James M. McPherson. Lincoln, Nebr.: The University of Nebraska Press, 1997 (1886).
- Yans-McLaughlin, Virginia. *Family and Community: Italian Immigrants in Buffalo, 1880-1930*. Urbana: University of Illinois Press, 1982.
- Young, James Harvey. *Pure Food: Securing the Federal Food and Drugs Act of 1906*. Princeton: Princeton University Press, 1989.

Secondary Sources – Journal Articles

- Brown, Martin and Peter Philips. "Craft Labor and Mechanization in Nineteenth-Century American Canning." *The Journal of Economic History*, Volume 46, Number 3 (September, 1986): 743-756.
- Busch, Jane. "An Introduction to the Tin Can." *Historical Archaeology*, Volume 15, Number 1 (1981): 95-104.
- Cowan, Ruth Schwartz. "The 'Industrial Revolution' in the Home: Household Technology and Social Change in the 20th Century." *Technology and Culture*, Volume 17, Number 1 (January, 1976): 1-23.
- Cowell, Norman D. "Who Introduced the Tin Can? – A New Candidate." *Food Technology*, Volume 49, Number 12 (December, 1995): 61-64.

- Davidson and Weiss Architects. "Manufacturing Plant of the Continental Can Company, Incorporated, Clearing, Illinois." *The American Architect*, February 27, 1918: 253-259.
- Demer, John H. "How Tinsmiths Used Their Tools." *The Chronicle of the Early American Industries Association*, Volume 26, Number 4 (December 1973): 49-57.
- Dodge, M. L. "The Mechanical Features of Salmon Canning." *Mechanical Engineering*, Volume 47, Number 8 (August 1925): 612-613.
- Goldblith, Samuel A. "Controversy Over the Autoclave: Who First Used the Autoclave for the Preservation of Foods?" *Food Technology*, Volume 26, Number 12 (December 1972): 62-65.
- Keuchel, Edward F. "Master of the Art of Canning: Baltimore, 1860-1900." *Maryland Historical Magazine*, Volume 67, Number 4 (Winter, 1972): 351-362.
- Koehn, Nancy F. "Henry Heinz and Brand Creation in the Late Nineteenth Century: Making Markets for Processed Foods." *The Business History Review*, Volume 73, Number 3 (Autumn, 1999): 349-393.
- Moran, Barbara. "Dinner Goes to War." *American Heritage of Invention & Technology*, Volume 14, Number 1 (Summer 1998): 10-19.
- Newell, Dianne. "The Rationality of Mechanization in the Pacific Salmon-Canning Industry before the Second World War." *The Business History Review*, Volume 62, Number 4 (Winter, 1988): 626-655.
- Petrack, Gabriella M. "An Ambivalent Diet: The Industrialization of Canning." *The Magazine of History*, Volume 24, Number 2 (July 2010): 35-38.
- Petroski, Henry. "Form Follows Failure." *American Heritage of Invention & Technology*, Volume 8, Number 2 (Fall 1992): 54-61.
- Powers, J. J., Colonel. "Rations." *The Quartermaster Review*, Volume 22, Number 1 (July-August, 1942): 39-40, 128-130.
- Rock, James T. "Cans in the Countryside." *Historical Archaeology*, Volume 18, Number 2 (1984): 97-111.
- Van Vleet, H. S. "Engineering the Tin Can." *Mechanical Engineering*, Volume 70, Number 4 (April 1948): 315-320.

Secondary Sources – Dissertations

Keuchel, Edward F., Jr. "The Development of the Canning Industry in New York State to 1960." PhD dissertation, Cornell University, 1971.

Petrick, Gabriella M. "The Arbiters of Taste: Producers, Consumers and the Industrialization of Taste in America, 1900-1960." PhD dissertation, University of Delaware, 2006.

Turner, Katherine Leonard. "Good Food for Little Money: Food and Cooking Among Urban Working-Class Americans, 1875-1930." PhD dissertation, University of Delaware, 2008.

Wilde, Mark William. "Industrialization of Food Processing in the United States, 1860-1960." PhD dissertation, University of Delaware, 1988.

Secondary Sources – Electronic Publications

<http://stat1.moneycontrol.com/Dow> Jones Industrial Average Historical Components.pdf (accessed May 23, 2013).

<http://legal-dictionary.thefreedictionary.com/Robinson-Patman+Act> (accessed April 7, 2015).

http://www.americanbar.org/groups/young_lawyers/publications/the_101_201_practice_series/robinson_patman_act.html (accessed April 7, 2015).

<http://www.cancentral.com/food-cans/facts> (accessed February 22, 2015).

http://www.minneapolisfed.org/community_education/teacher/calc/hist1800.cfm (accessed April 21, 2014).

<http://www.waynecountylife.com/2009/06/edgett-burnham-canning-company.html> (accessed October 2, 2014).

Gregg S. Pearson

gsp208@lehigh.edu

Education:

Ph.D. Candidate in History, Lehigh University, Bethlehem, PA, 2008 to present. The expected date of completion is January 2016.

Concentrations: History of Technology, American Military History, American Labor and Urban Social History 1880-1930, the French Atlantic World

Dissertation: The Democratization of Food: Tin Cans and the Growth of the American Food Processing Industry, 1810-1940

M. A., History, La Salle University, Philadelphia, PA, 2007

Concentrations: Early American Republic, American Antebellum and Civil War Era

M. S., Industrial Engineering, Northwestern University, Evanston, IL, 1992

Concentrations: Statistics, Manufacturing Management, Operations Research

B. S., General Engineering, United States Military Academy, West Point, NY, 1982

Concentration: Operations Management, Engineering Science, American Military History

Employment History:

2008 – Present: Doctoral Candidate at Lehigh University. Course requirements are completed and the written and oral comprehensive examinations were passed in April 2012. Entered Doctoral Candidacy in January 2014. Additional responsibilities included: Teaching Assistant for HI 110 American Military History the Fall Term 2011 and Adjunct Lecturer for HI 110 American Military History for four terms. Received an aggregate rating of at least 4.87 on a scale of 5 on class evaluations every term.

1992-2008: Regional Vice President and Plant Manager, Ball Corporation, Horsham, PA. Responsible for the leadership, training, personal management, labor relations, manufacturing operations, budgeting, and profitable management of seven manufacturing plants in five states with an employee population of 1,200 and annual revenues exceeding 350 million dollars. Conducted numerous presentations and plant tours for audiences ranging from a few customers to hundreds of employees.

1982-1992: Major, Infantry, United States Army. Responsible for leading, training, soldier and family welfare, operational planning, and mission execution in both line and staff positions in both the United States and overseas locations. Served in command positions and staff assignments in units from platoon (40 soldiers) to brigade level (3,000 soldiers). Service included combat operations during Operation Just Cause in Panama in 1989-1990.

Teaching Experience

<u>Date</u>	<u>Position</u>	<u>Location</u>	<u>Course</u>
Fall 2011	Teaching Assistant	Lehigh University	American Military History
Spring 2013	Adjunct Lecturer	Lehigh University	American Military History
Fall 2013	Adjunct Lecturer	Lehigh University	American Military History
Fall 2014	Adjunct Lecturer	Lehigh University	American Military History
Fall 2015	Adjunct Lecturer	Lehigh University	American Military History

Public Lectures

Freshman Orientation Lecture Series, Lehigh University, Bethlehem, Pennsylvania, "The American Armed Forces and Society," October 28, 2015.

Publications:

The Light Infantry Handbook. Fort Benning, GA: The Light Infantry Task Force, 1987.

Third Brigade, 7th Infantry Division (Light) Combat Standard Operating Procedures. Fort Ord, CA: Fort Ord Printing Center, 1989.

Machine Set-Up Procedures for Can End Punch Presses. Oak Brook, IL: United States Can Company, 1993.

The Technical Asset Base of the Future Can Plant. Oak Brook, IL: United States Can Company, 1995.

Review of *Execution: The Discipline of Getting Things Done*, by Ram Charan. *U. S. Can Today*, May 2003.

Awards, Grants, and Fellowships:

Strohl Summer Research Grant, Lehigh University, Summer 2013

Hoben Teaching Fellowship, Lehigh University, Spring Term 2013

College of Arts and Sciences Scholarship, Lehigh University, 2008-2011

Army Advanced Civil Schooling Fellowship, Northwestern University, 1990-1992

Numerous business awards for exemplary customer service, quality, profitability, and employee safety, 1992-2008

Numerous military awards for valor, combat service, and meritorious service, 1982-1992

Academic Community Service:

History and American Studies Graduate Student Representative to the Graduate Student Senate, Lehigh University, 2008 – 2012

Graduate Student Senate Travel Grants Officer, Lehigh University, 2009 – 2012

History Department Representative to the CAS Graduate Student Advisory Board, Lehigh University, 2009 – 2012

Graduate Member of the Dean’s Committee on Discipline, Lehigh University, 2010 - 2015

Research Skills and Qualifications:

Microsoft Office (Word, Excel, PowerPoint)

Some programming ability in SAS and SPSS

Conversant in German

Professional Memberships:

American Historical Association

American Legion Post 210

Veterans of Foreign Wars Post 175

Lifetime Member of the 17th Infantry Regiment Association

Interests: I enjoy hiking, skiing, playing ice hockey, golfing, cooking, gardening, bird watching, and spending time with my family.

References: Available upon request